

---

# Large international collaborations in particle physics

Peter Križan

*University of Ljubljana + J. Stefan Institute  
+ visiting prof. at University of Nagoya*

# Contents

---

- Why is particle physics interesting at all?
- Research in experimental particle physics
- Large collaborations: a necessity and a challenge
- Example: Belle-II at SuperKEKB
- More examples
- Summary

# Relation between elementary particle physics and the development of the early Universe

Early Universe: extremely dense → extremely high temperatures (like in gas after compression in the car engine)

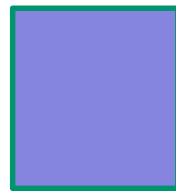

Gas at high temperatures: molecules and atoms have high velocities

Collisions between particles in the early Universe:  
just like collisions of particles in accelerators  
→ Similar processes



# Temperature of the Universe

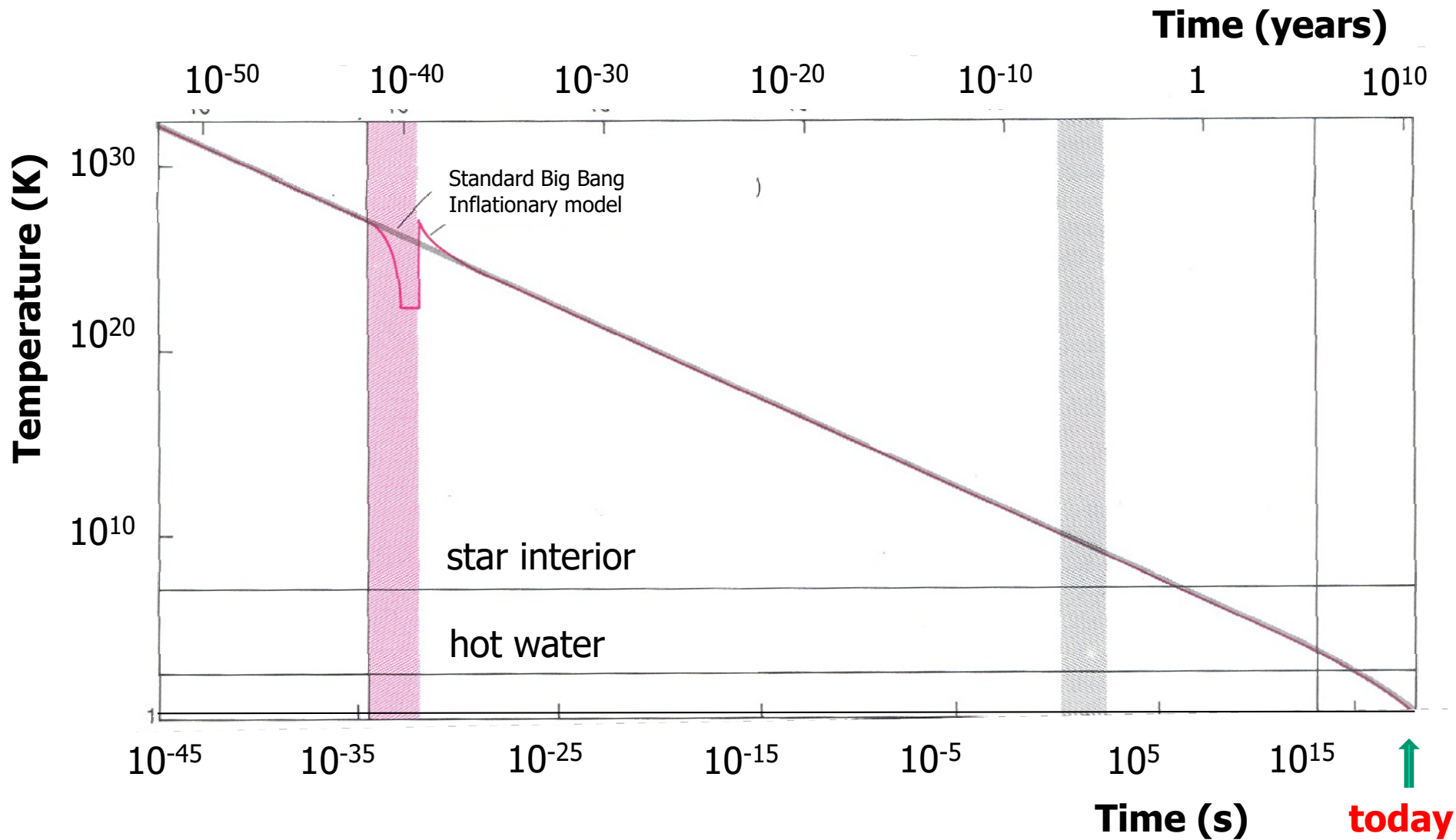



One of the really big questions: why is there a difference between the number of particles and anti-particles?

Out of 10 billions of particles and 10 billions of anti-particles in the early Universe only

**1 particle survived!**

10.000.000.000 particles

10.000.000.000 anti-particles

1 particle

0 anti-particles

# CP symmetry and its violation

---

Symmetry operation **CP**: transforms a **particle** into its **anti-particle**

If the two do not behave in the same way – e.g., if they decay differently → violation of CP symmetry

Since there were equal amounts of particles and anti-particles in the early Universe, while today the Universe contains only matter (=particles) and almost no anti-matter (anti-particles)

→ This symmetry is obviously **violated!**



**Very important to understand how and why this symmetry is violated.**

# Particle physics experiments

---

Accelerate elementary particles, let them collide → energy released in the collision is converted into mass of new particles, some of which are unstable

Two ways how to do it:

Fixed target experiments

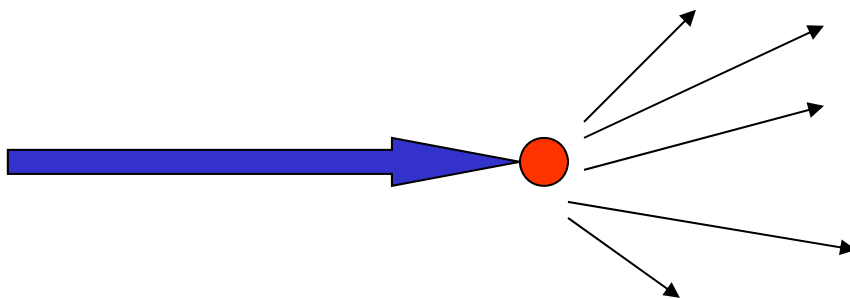

Collider experiments

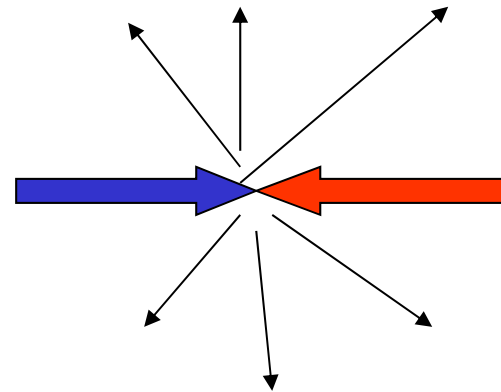

# How to accelerate charged particles?

- Acceleration with electromagnetic waves (typical frequency is 500 MHz – mobile phones run at 900, 1800, 1900 MHz)
- Waves in a radiofrequency cavity:  $c < c_0$

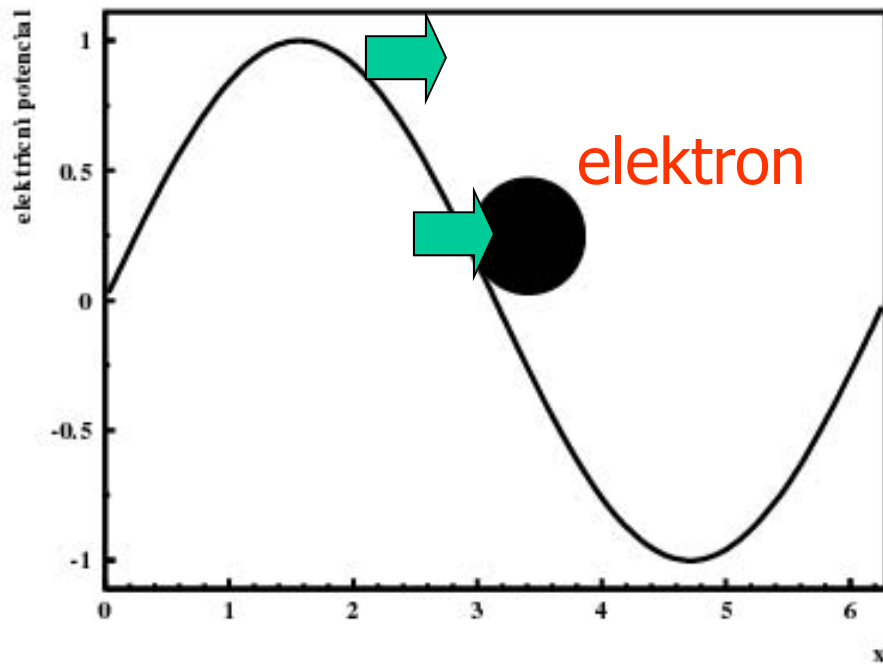

... Similar to surfing the waves

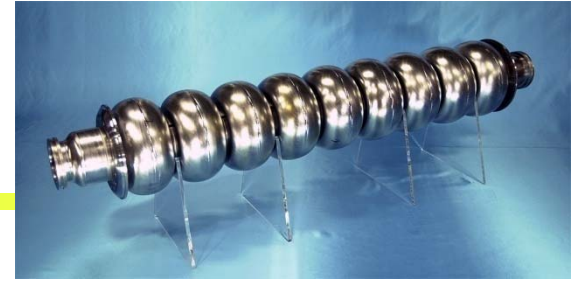

Electric field

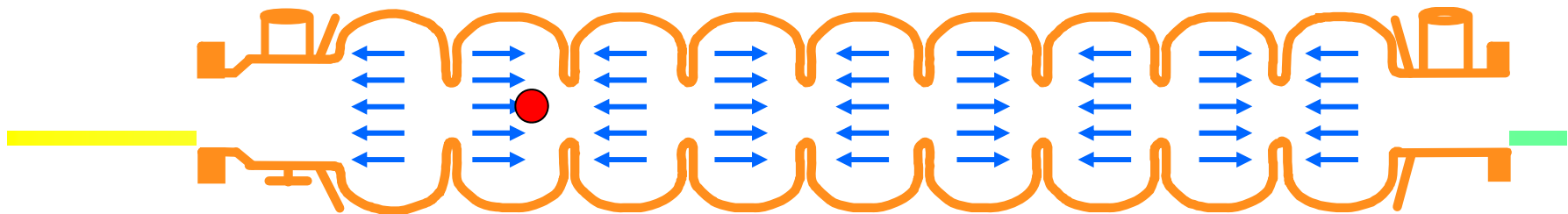
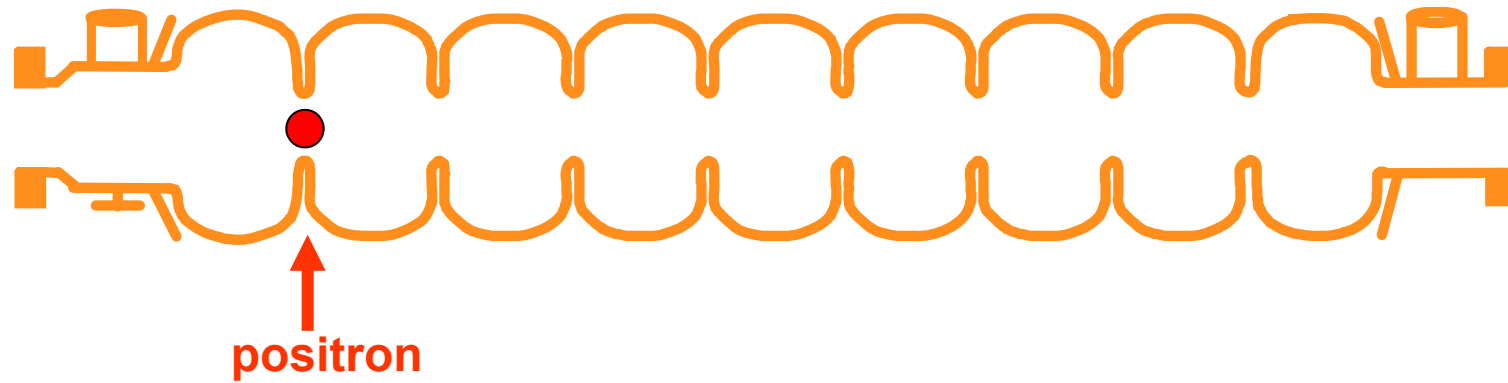
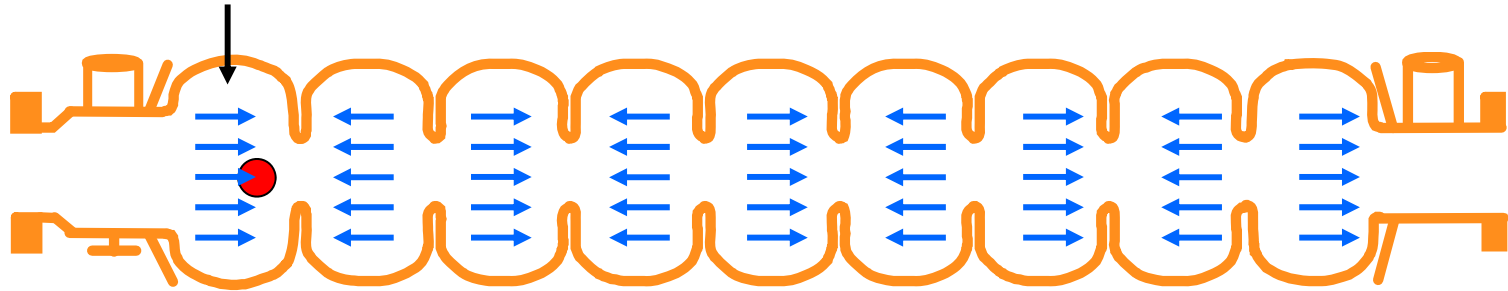

# KEK-B collider for electrons and positrons

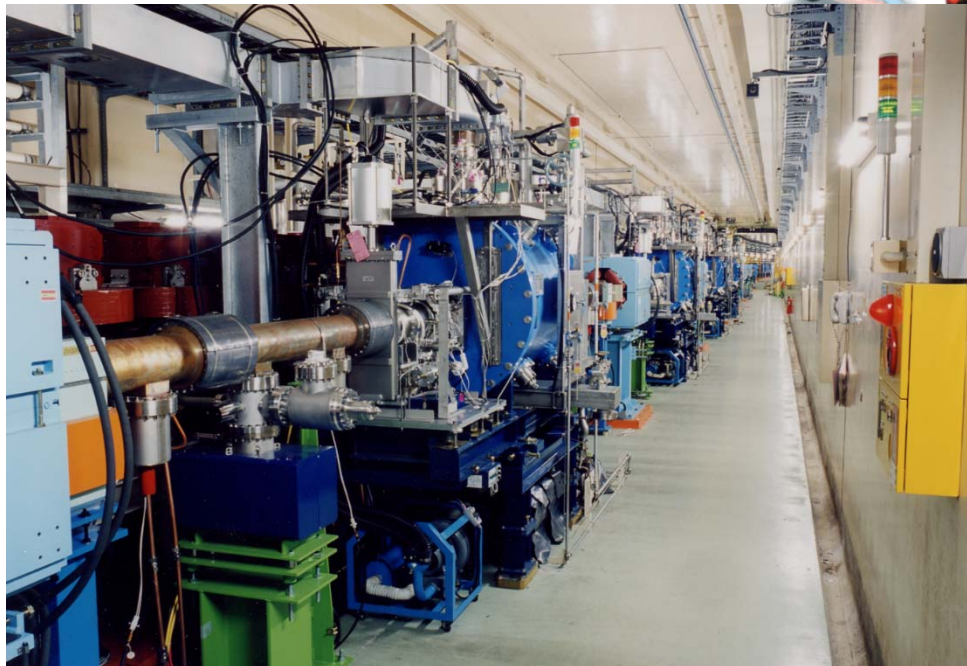
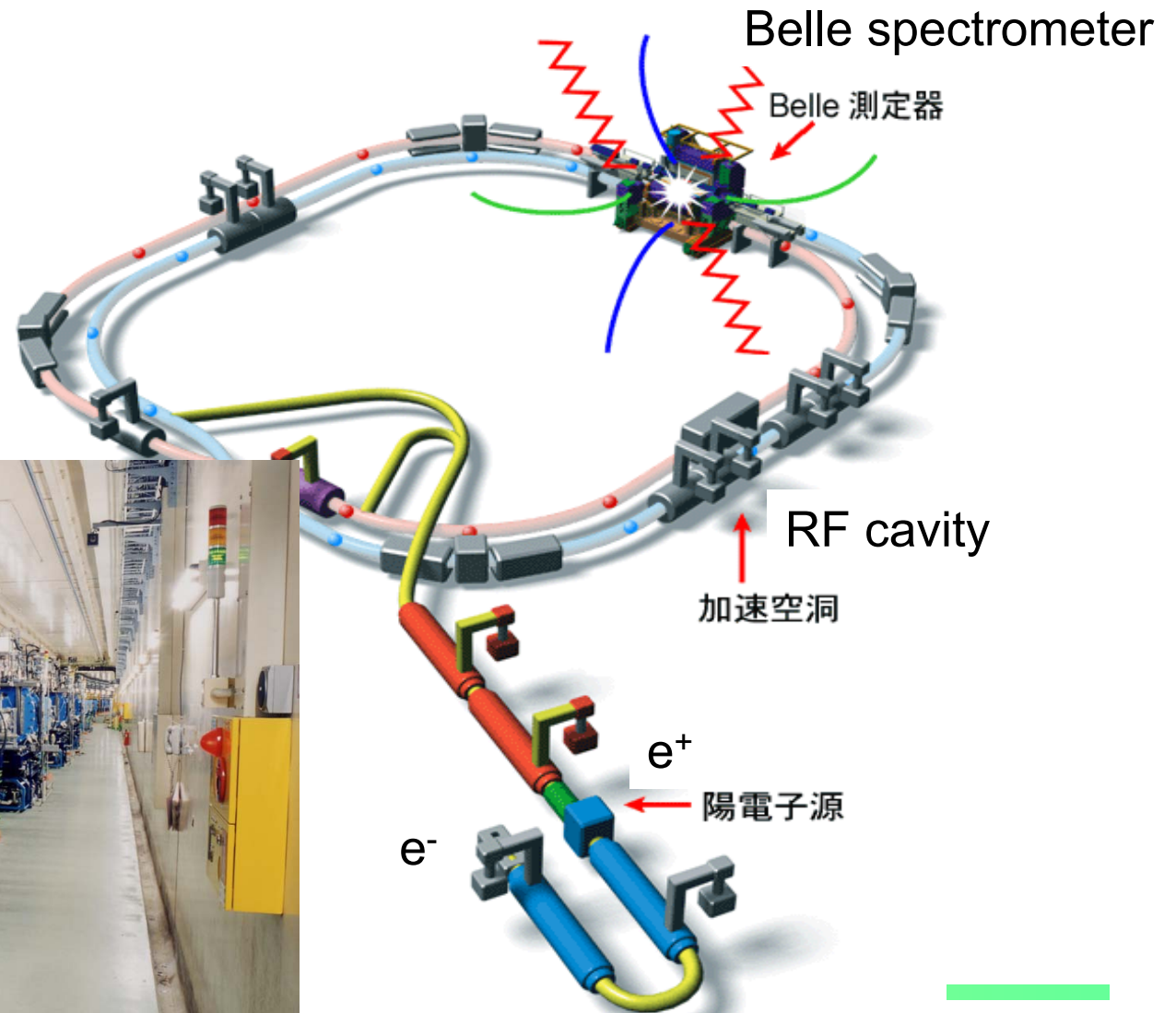



# Large hadron collider

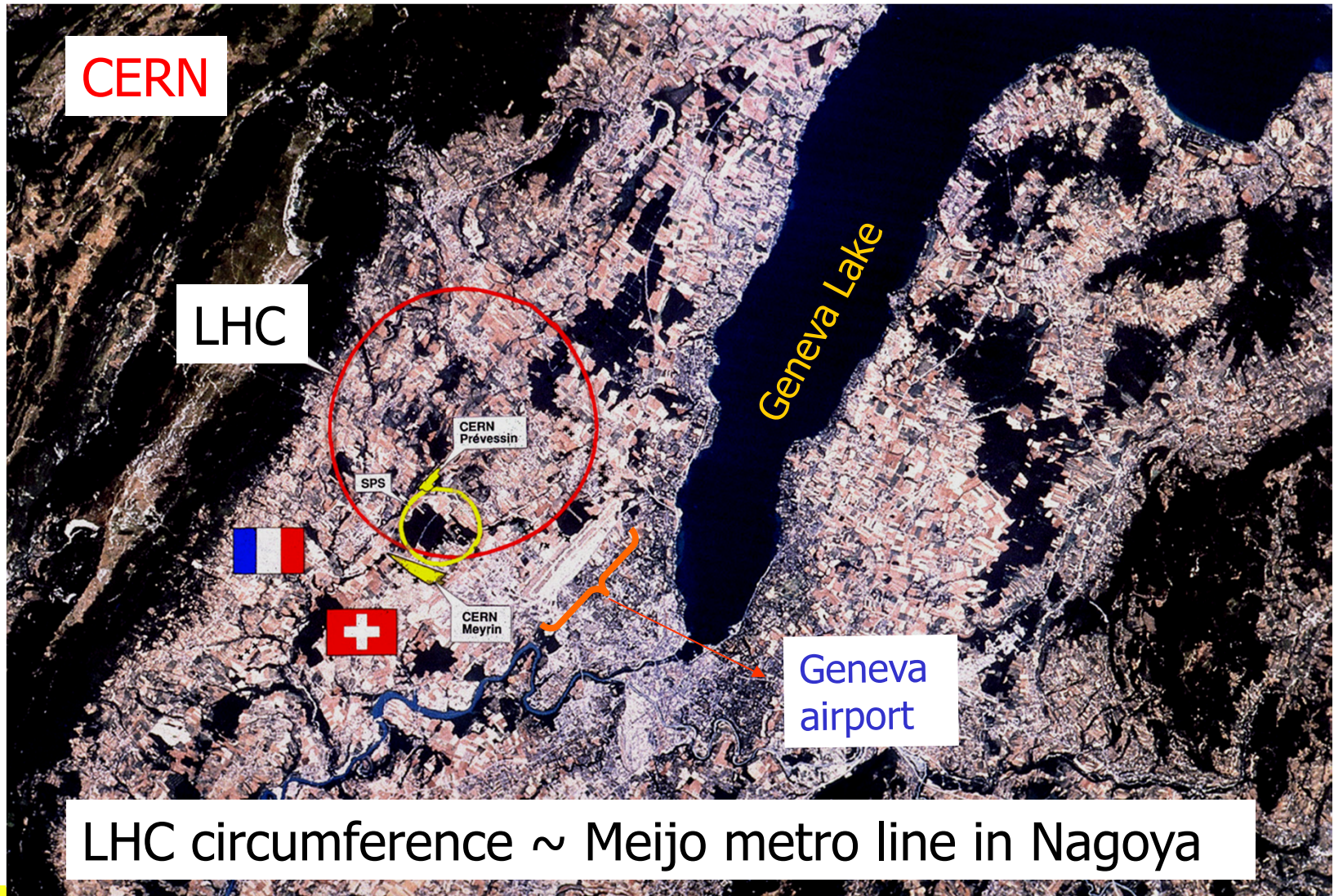

# Accelerator figure of merit 1: Center-of-mass energy

If there is enough energy available in the collision, new, heavier particles can be produced.

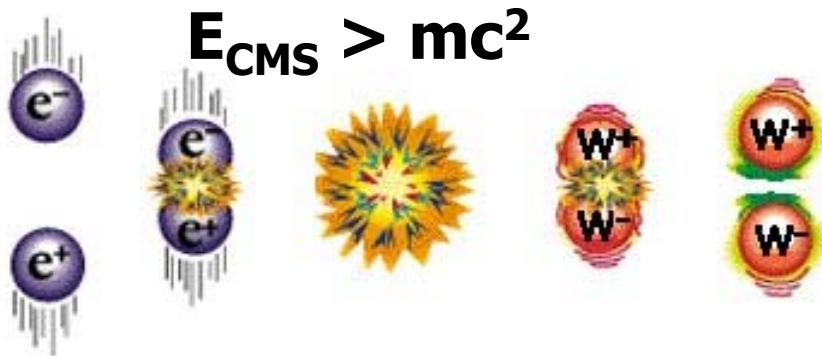

e.g. LHC, CERN: search for new particles with  $m > 100\text{GeV}$

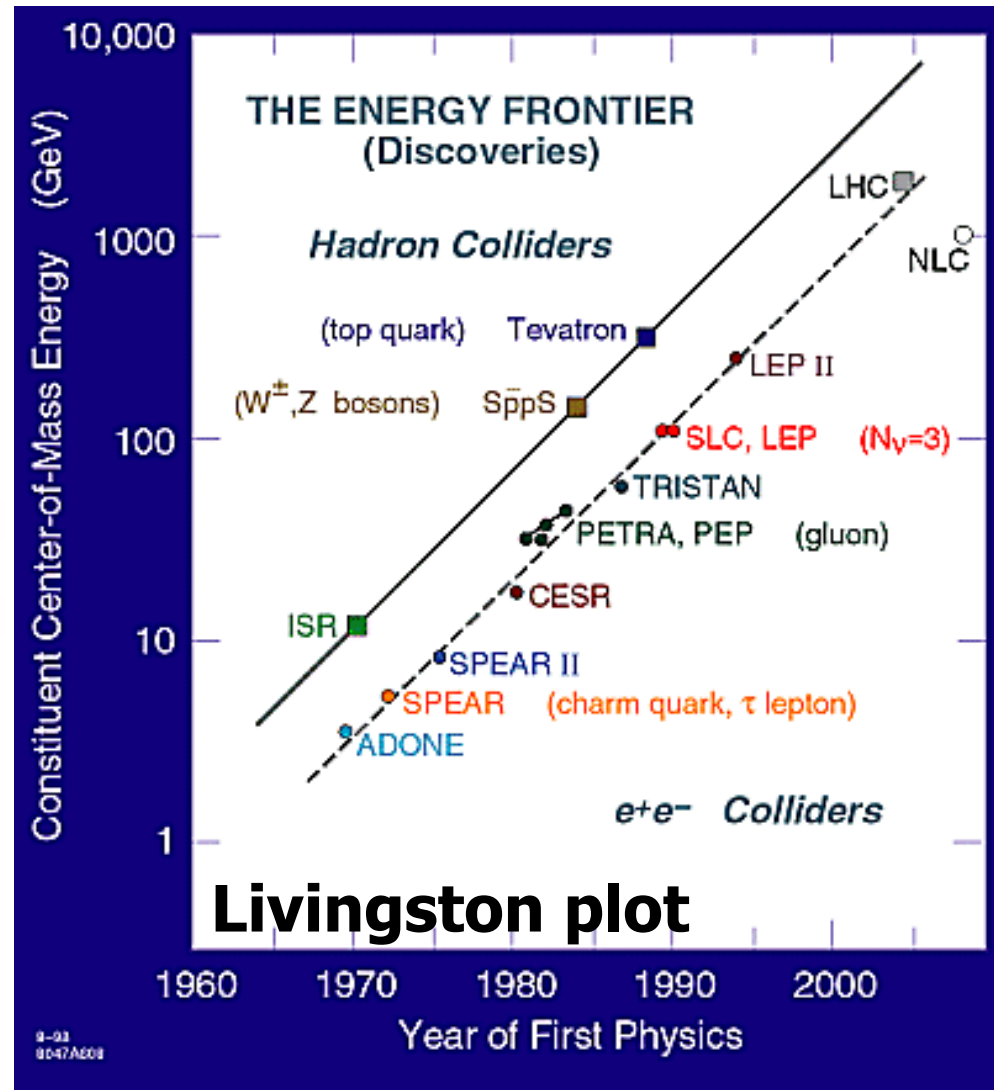



# Two complementary approaches

---

Two complementary approaches to search for the so far unobserved processes and particles: the **energy frontier** and the **intensity frontier** .

**Energy frontier** : direct search for production of unknown particles at the highest achievable energies.

**Intensity frontier** : search for rare processes, deviations between theory predictions and experiments with the ultimate precision.

→ for this kind of studies, one has to investigate a very large number of reactions ("events") → need accelerators with ultimate **intensity** ("luminosity")

# Comparison of **energy** / **intensity** frontiers

To observe a large ship far away one can either use **strong binoculars** or observe **carefully the direction and the speed of waves** produced by the vessel.

## Energy frontier (LHC)



## Luminosity frontier (SuperKEKB)

# Accelerator figure of merit 2: Luminosity

---

Observed rate of events = Cross section x Luminosity

$$\frac{dN}{dt} = L\sigma$$

Accelerator figures of merit: **luminosity  $L$**

and **integrated luminosity**

$$L_{\text{int}} = \int L(t) dt$$

**High luminosity is needed for studies of rare processes.**

---

# Luminosity vs time

$$R = \mathcal{L}\sigma$$

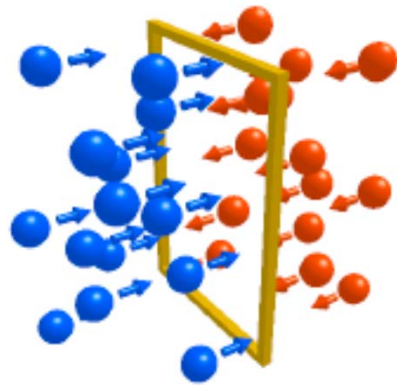

(number of events/unit time)  
= (cross section) X (luminosity)

$$\mathcal{L} = \frac{I_{LER} I_{HER}}{e^2 f_{rev} N_{bunch} A_{eff}}$$

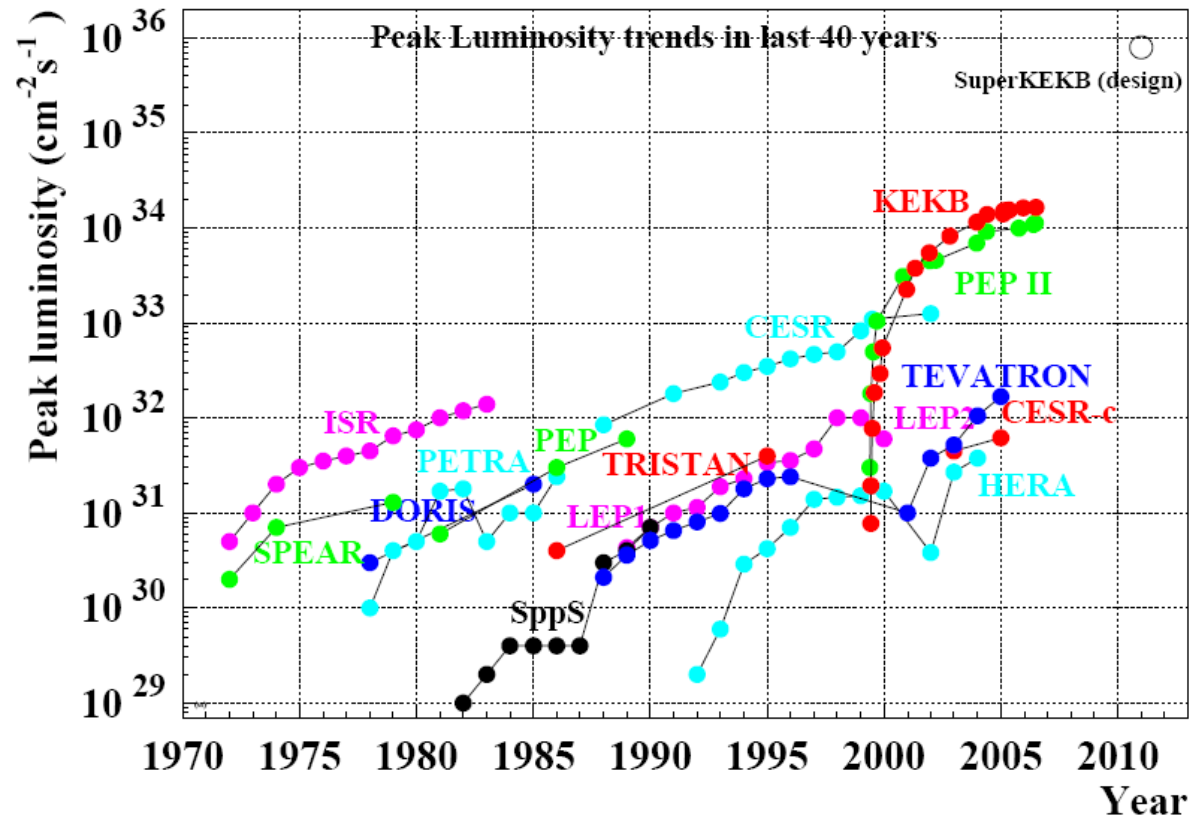

High luminosity is needed for studies of rare processes.

# How to understand what happened in a collision?

Illustration on an example:

$$B^0 \rightarrow K^0_S J/\psi$$

$$K^0_S \rightarrow \pi^- \pi^+$$

$$J/\psi \rightarrow \mu^- \mu^+$$

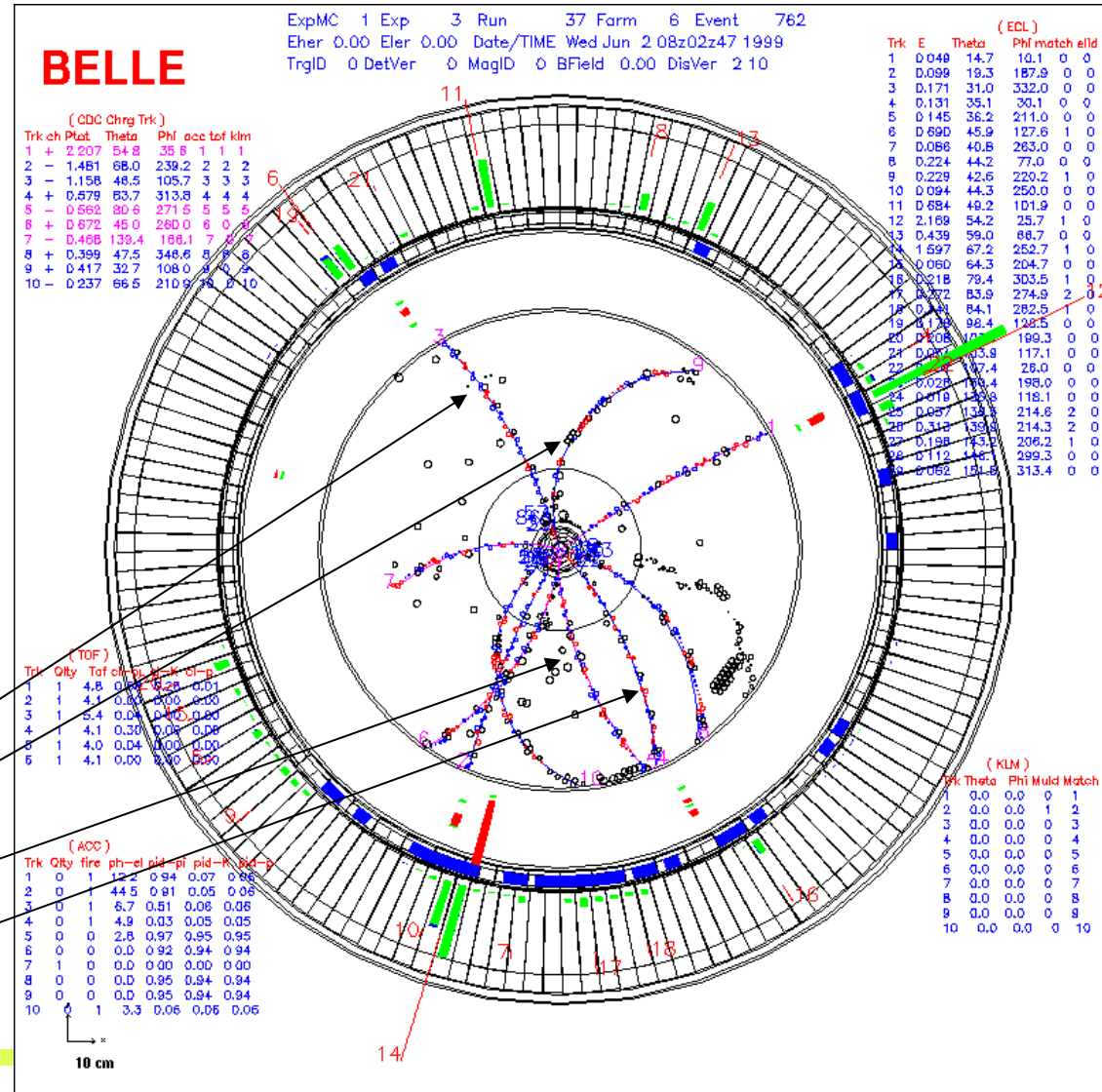

# How to understand what happened in a collision?

---

- Measure the coordinate of the point ('vertex') where the reaction occurred, and determine the positions and directions of particles that have been produced
- Measure momenta of stable charged particles by measuring their radius of curvature in a strong magnetic field ( $\sim 1\text{T}$ )
- Determine the identity of stable charged particles (e,  $\mu$ ,  $\pi$ , K, p)
- Measure the energy of high energy gamma rays

# Experimental apparatus

Detector form: **symmetric** for colliders with symmetric energy beams; **extended in the boost direction** for an asymmetric collider; **very forward oriented** in fixed target experiments.

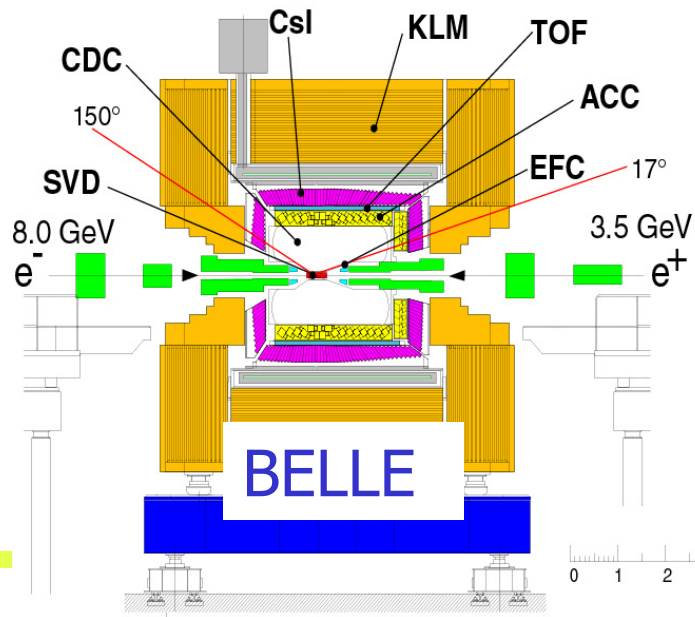
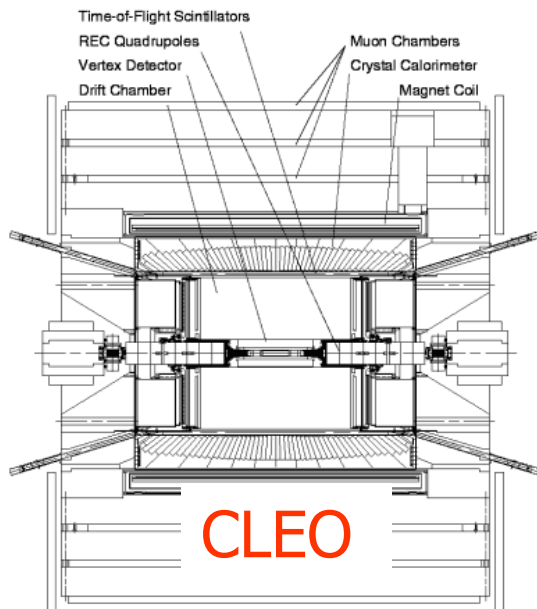
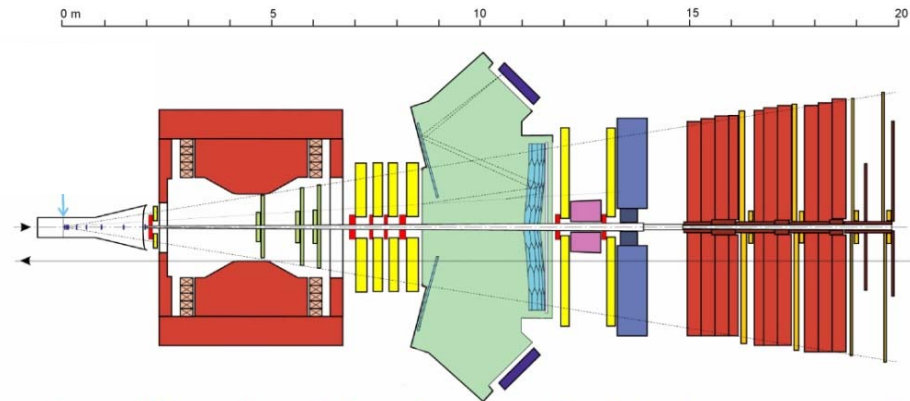
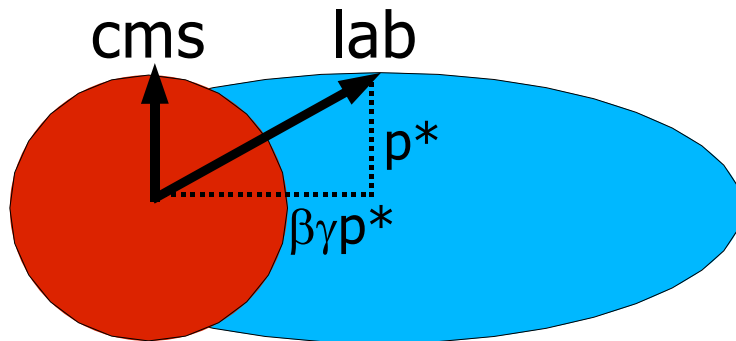



# Example of a fixed target experiment: HERA-B

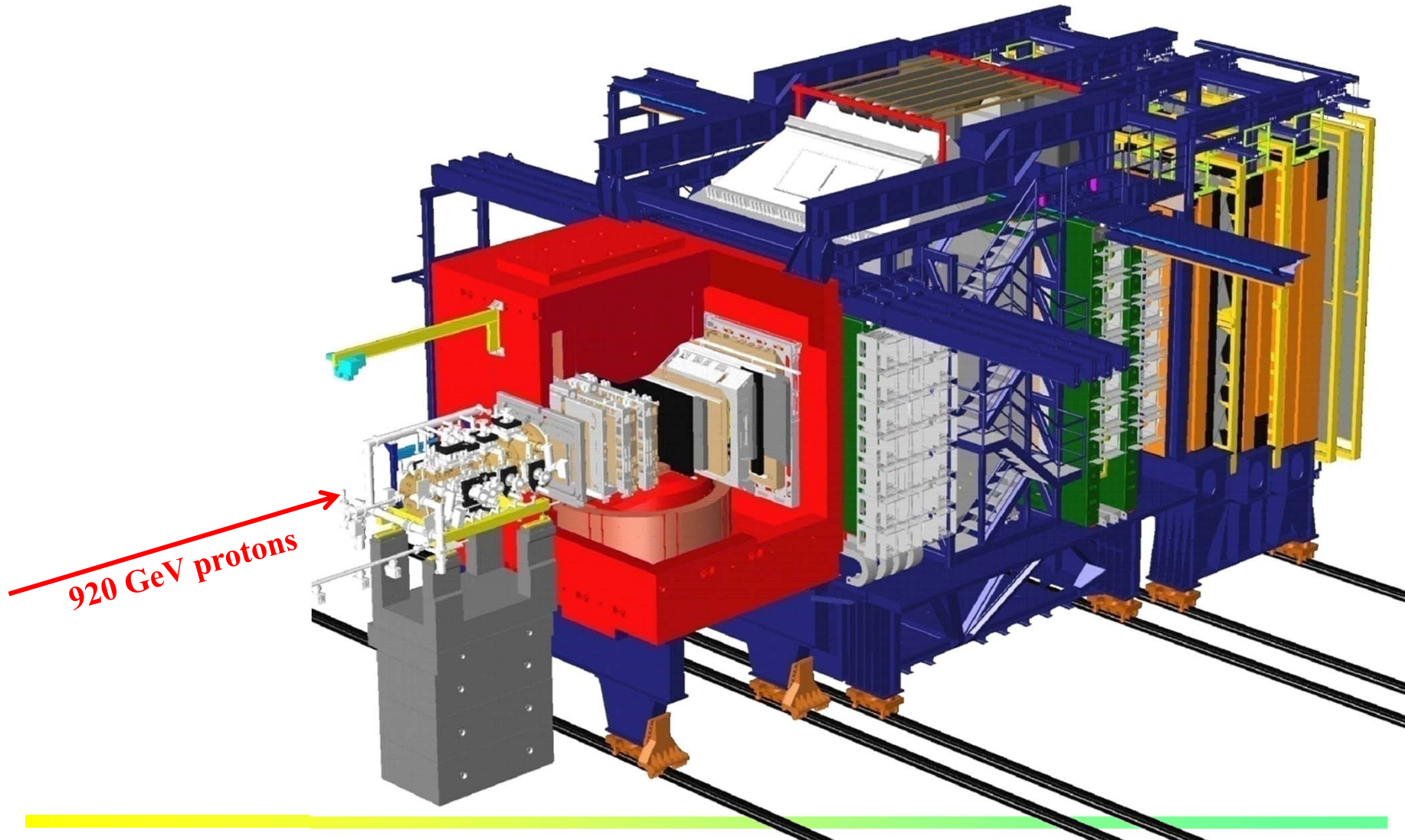
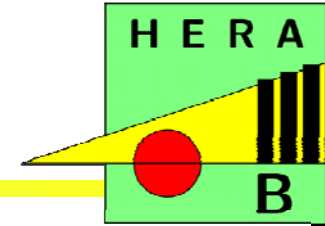



# Belle spectrometer at KEK-B

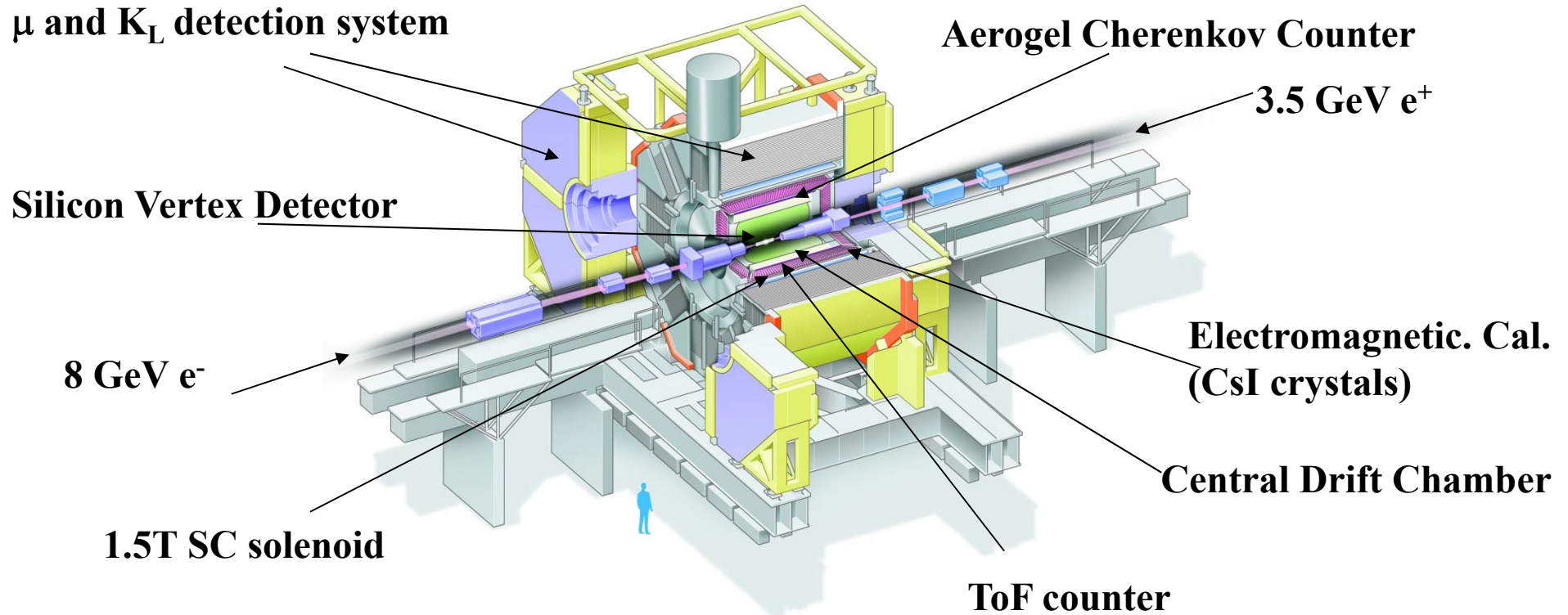

# ATLAS at LHC

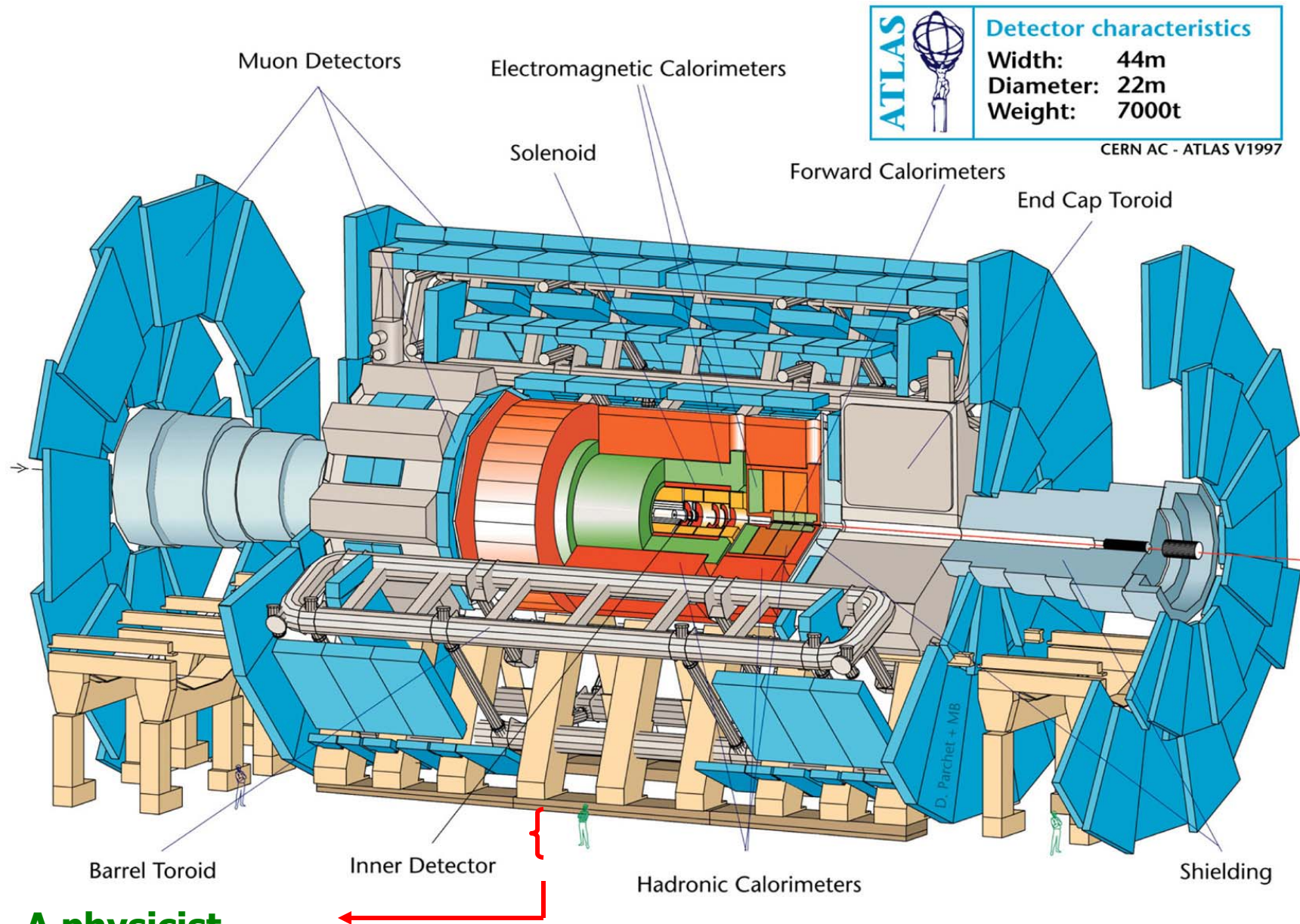

**A physicist...**

Peter Križan, Ljubljana

# How to carry out such large scale projects

---

For an experiment in particle physics one needs:

- an accelerator
- at least one detector

These are huge projects, requiring sizable resources both in funding and in expertise.

→ Large international collaborations: a necessity

However, scientific work in such a large international collaboration is **also a challenge!**



# Example: Belle and Belle II detectors at the $e^+e^-$ collider, KEK, Tsukuba

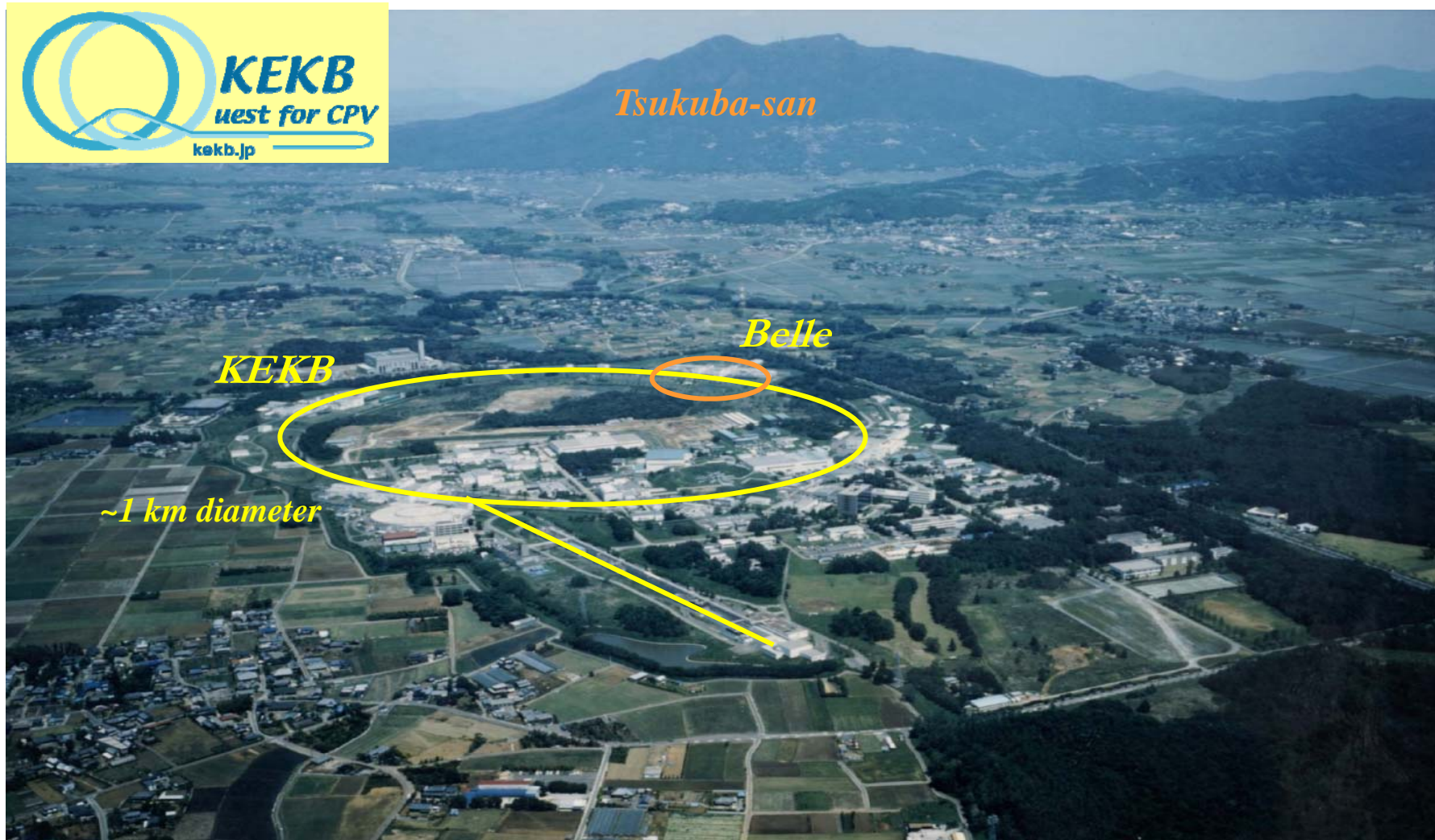

## A little bit of history...

---

**CP violation:** difference in the properties of particles and their anti-particles – first observed in 1964.

**M. Kobayashi and T. Maskawa (1973):** CP violation in the Standard model – related to the weak interaction quark transition matrix

Their theory was formulated at a time when three quarks were known – and they requested the existence of three more!

The last missing quark was found in 1994.

... and in 2001 two experiments – Belle and BaBar at two powerfull accelerators (B factories) - have further investigated CP violation and have indeed proven that it is tightly connected to the quark transition matrix

# KM's bold idea verified by experiment

Relations between parameters  
as expected in the Standard  
model →

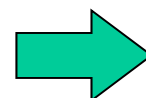
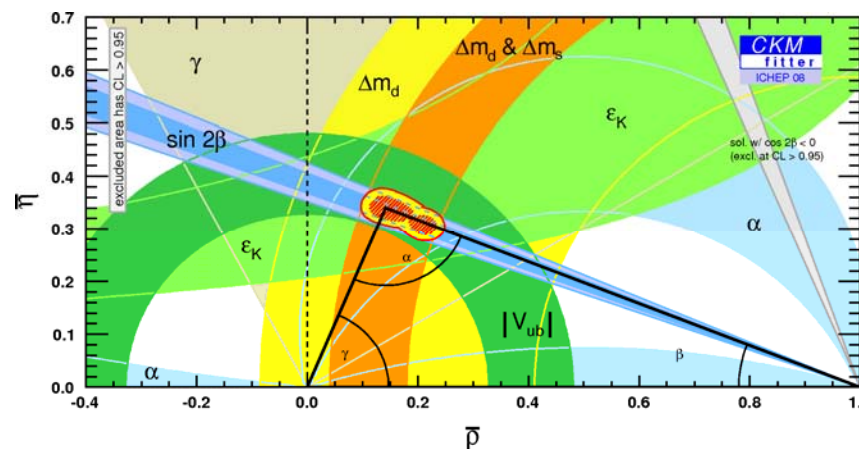

Nobel prize 2008!

→ With essential experimental confirmations by Belle and BaBar! (explicitly noted in the Nobel Prize citation)

# The KM scheme is now part of the Standard Model of Particle Physics

- However, the CP violation of the KM mechanism is too small to account for the asymmetry between matter and anti-matter in the Universe (falls short by 10 orders of magnitude !)
- SM does not contain the fourth fundamental interaction, gravitation
- Most of the Universe is made of stuff we do not understand...

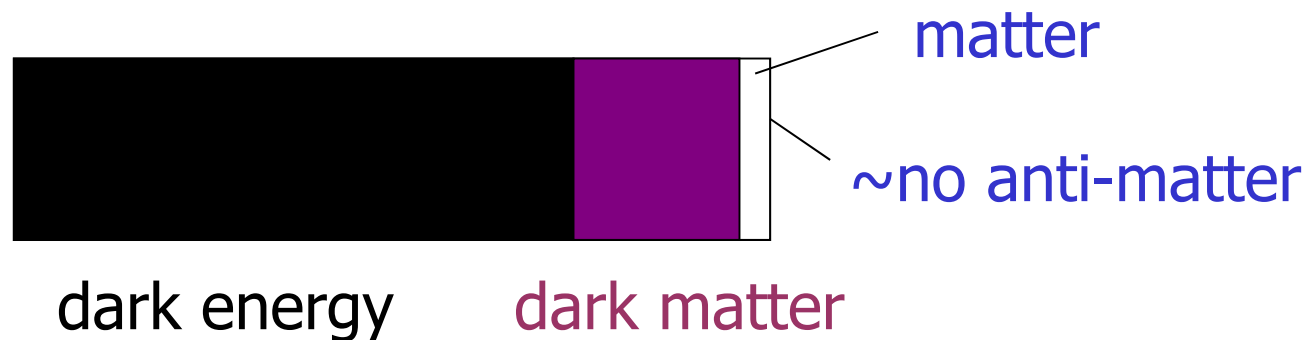

# Are we done ? (Didn't the B factories accomplish their mission, recognized by the 2008 Nobel Prize in Physics ?)



Из эссе С. Окубо  
при большой температуре  
для Вселенной сила слабого  
но ее кривой фигуры

НАРУШЕНИЕ CP-ИНВАРИАНТНОСТИ, C-АСИММЕТРИЯ  
И БАРИОННАЯ АСИММЕТРИЯ ВСЕЛЕННОЙ

А.Д. Сахаров

Теория расширяющейся Вселенной, предполагающая сверхплотное начальное состояние вещества, по-видимому, исключает возможность макроскопического разделения вещества и антивещества; поэтому следует

Matter - anti-matter  
asymmetry of the Universe:  
KM (Kobayashi-Maskawa)  
mechanism still short by 10  
orders of magnitude !!!



# Comparison of **energy** / **intensity** frontiers

To observe a large ship far away one can either use **strong binoculars** or observe **carefully the direction and the speed of waves** produced by the vessel.

**Energy frontier (LHC)**

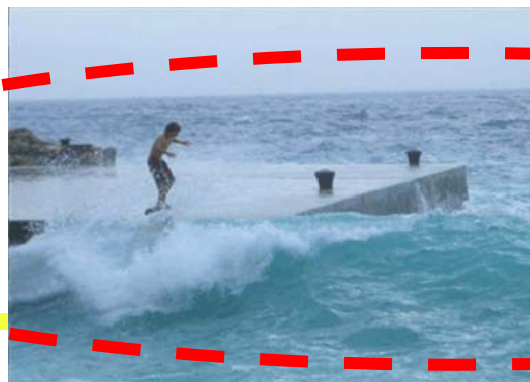

**Luminosity frontier  
(SuperKEKB)**



How to do it?

→ Upgrade KEKB and Belle

→ → SuperKEKB and Belle II

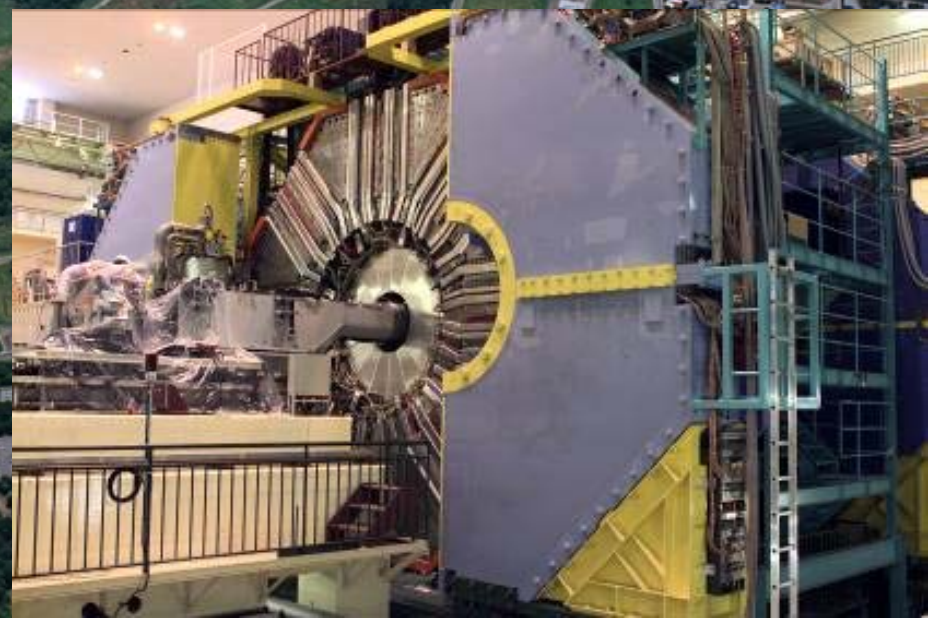
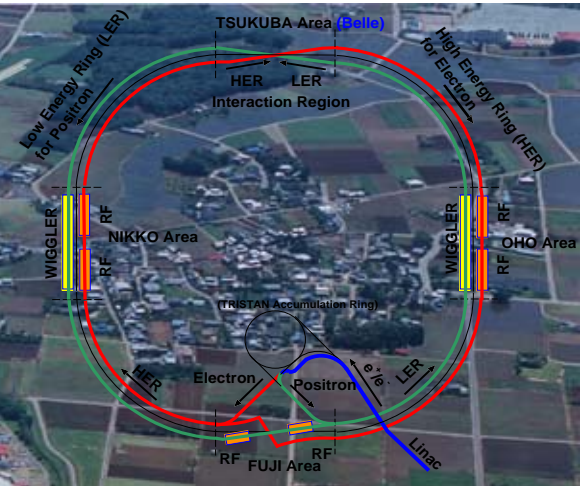



# The KEKB Collider

Fantastic performance far beyond design values!

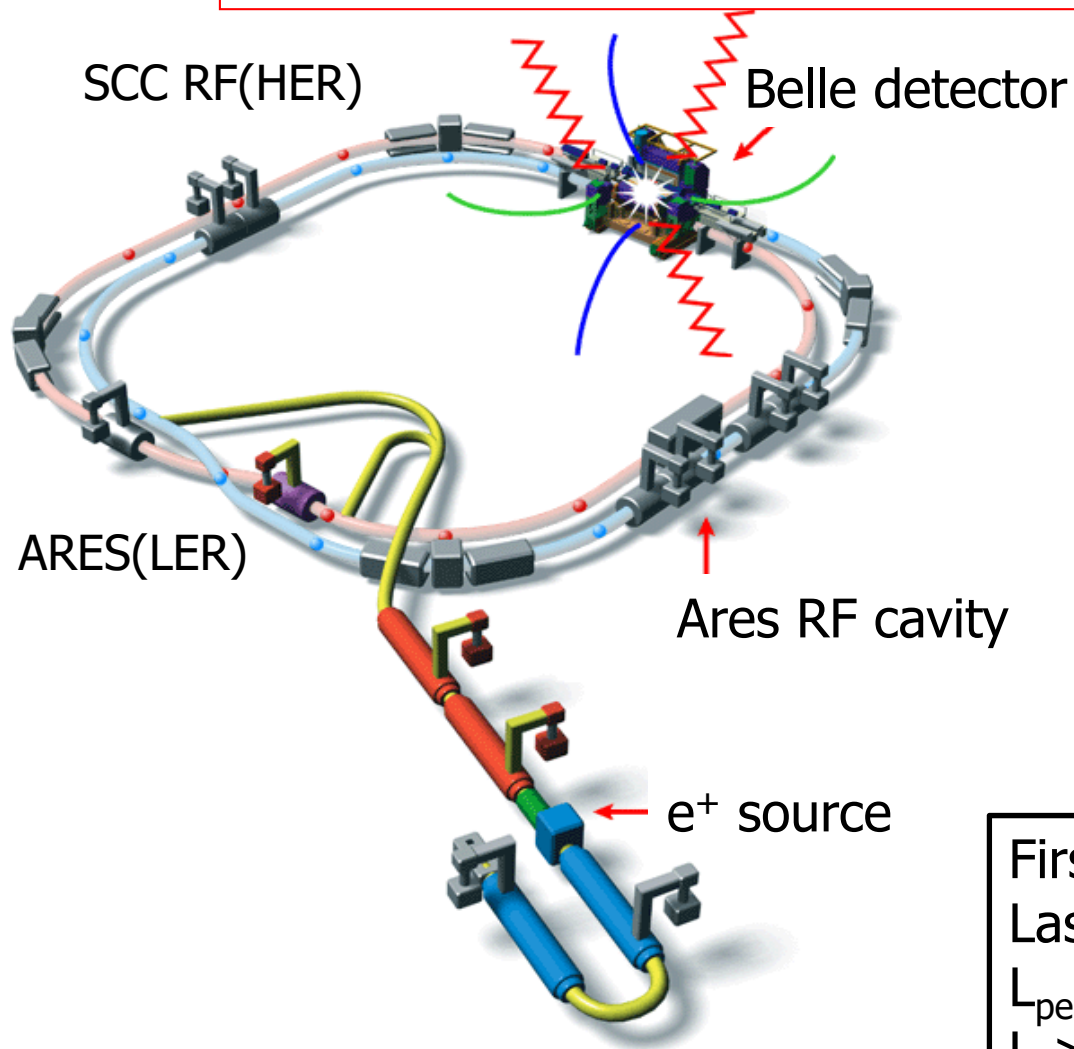

- e<sup>-</sup> (8 GeV) on e<sup>+</sup> (3.5 GeV)
  - $\sqrt{s} \approx m_{\Upsilon(4S)}$
  - Lorentz boost:  $\beta\gamma = 0.425$
- 22 mrad crossing angle

**Peak luminosity (WR!) :**  
 **$2.1 \times 10^{34} \text{ cm}^{-2}\text{s}^{-1}$**   
= 2x design value

First physics run on June 2, 1999  
Last physics run on June 30, 2010  
 $L_{\text{peak}} = 2.1 \times 10^{34} / \text{cm}^2/\text{s}$   
 $L > 1 \text{ ab}^{-1}$

# SuperKEKB is the intensity frontier

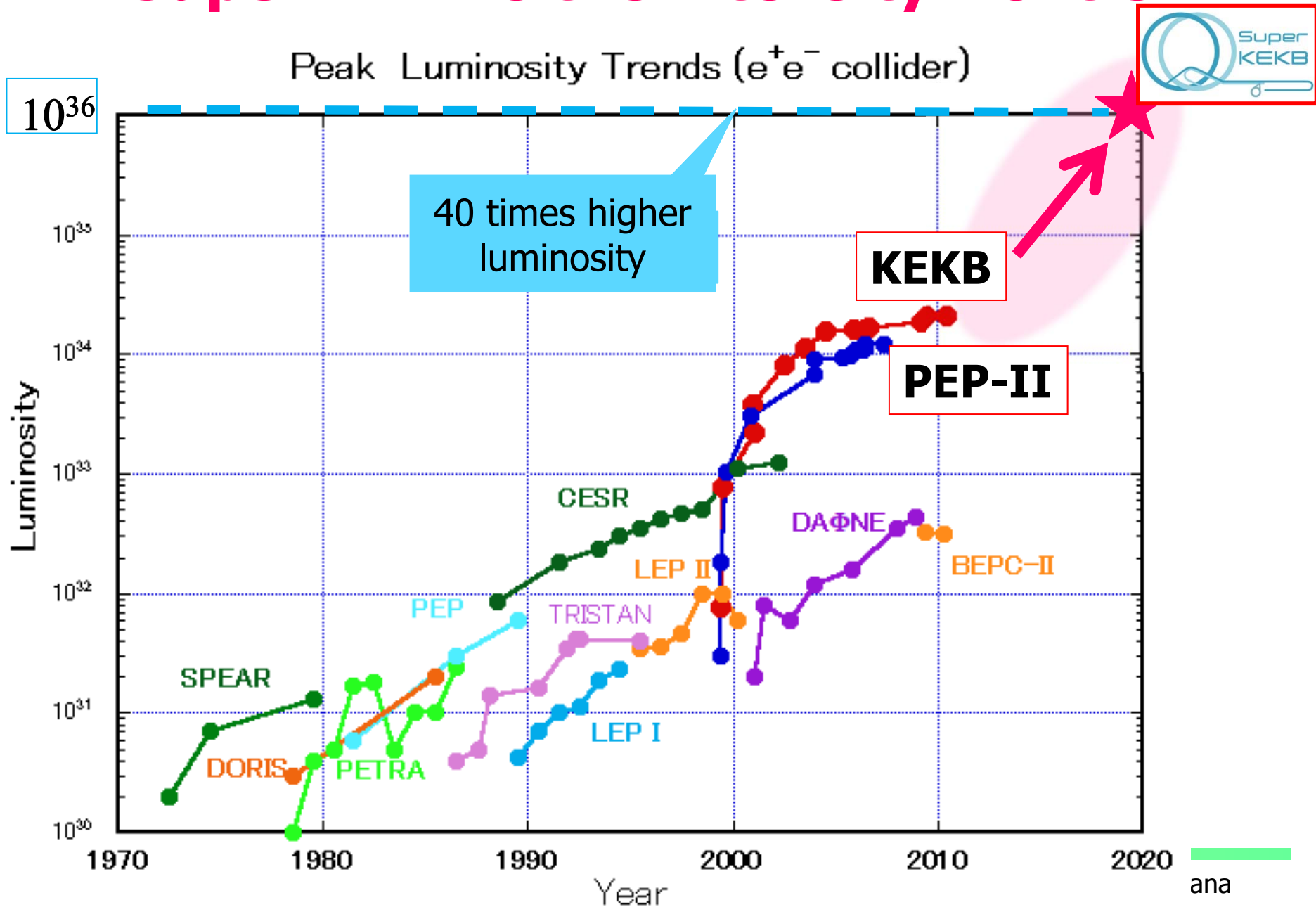

# How big is a nano-beam ?



How to go from an excellent accelerator with world record performance – KEKB – to a 40x times better, more intense facility?

In KEKB, colliding electron and positron beams are **much thinner than the human hair...**

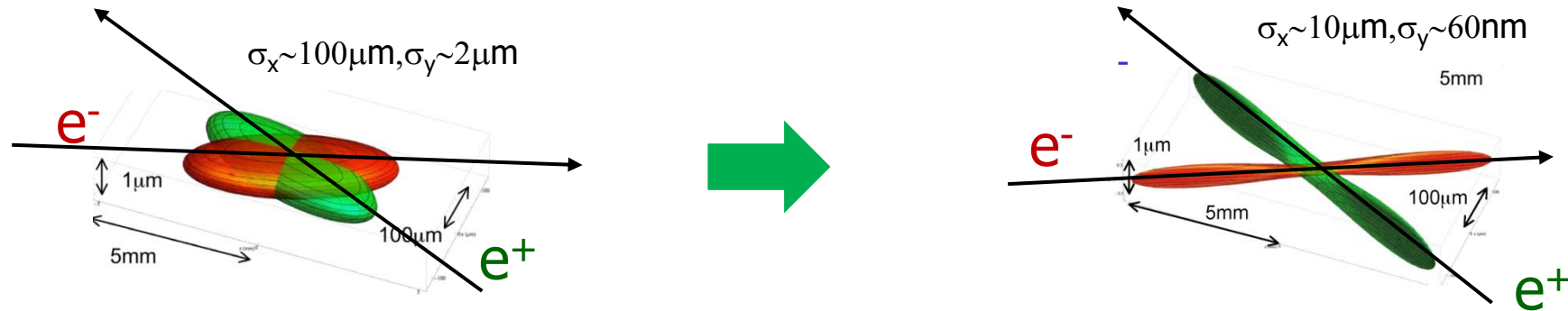

... For a 40x increase in intensity you have to make the beam as thin as **100 atomic layers!**

# KEKB to SuperKEKB



Colliding bunches

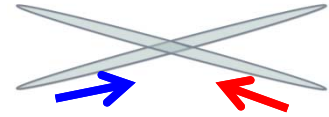

New superconducting / permanent final focusing quads near the IP

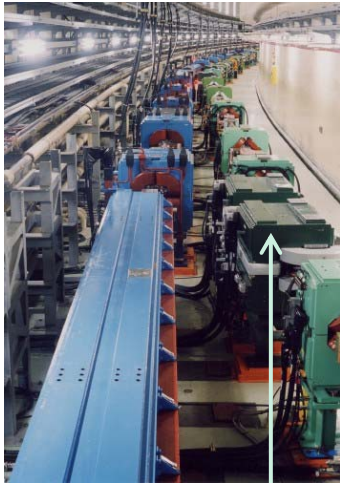
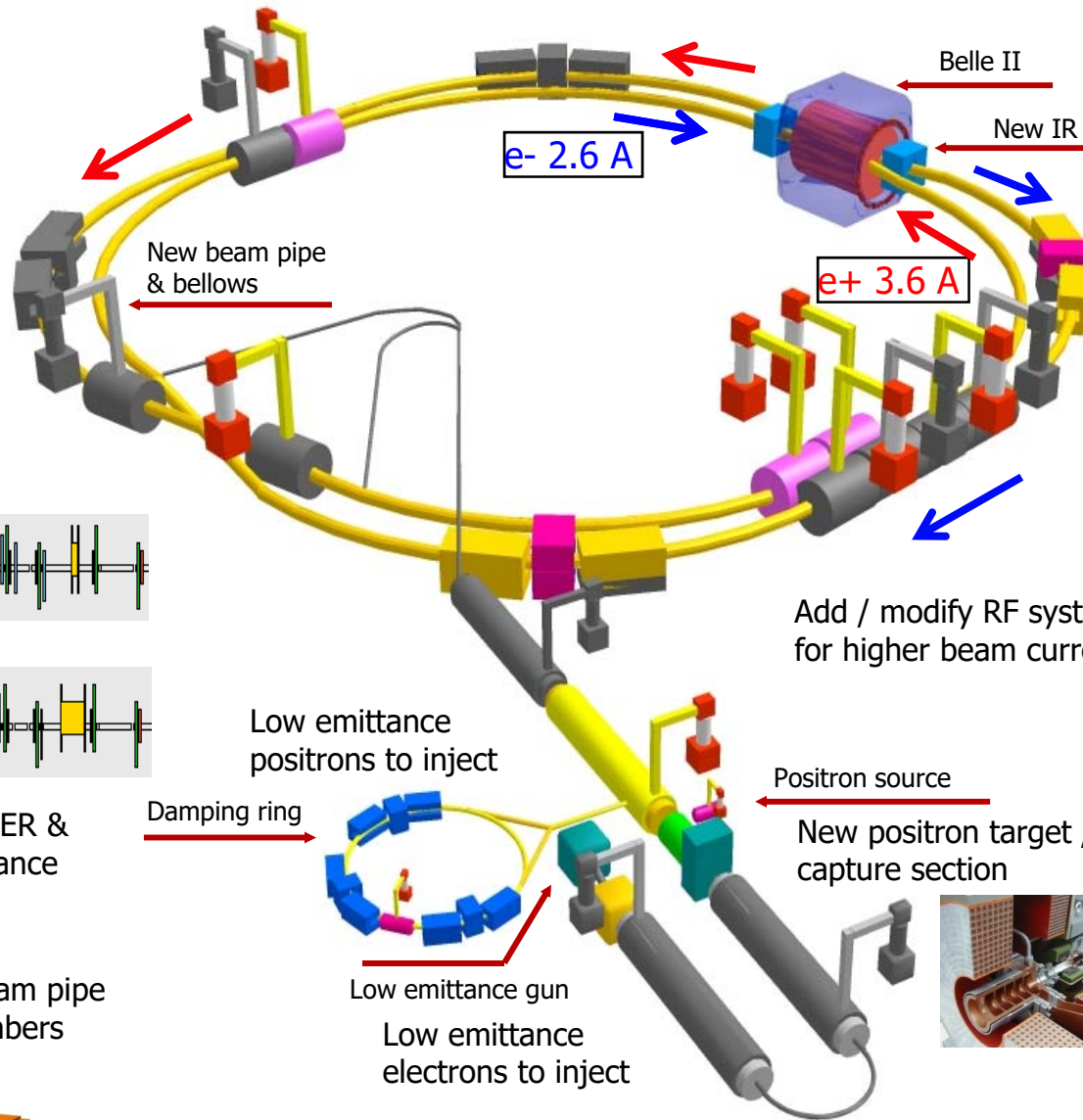

Replace short dipoles with longer ones (LER)

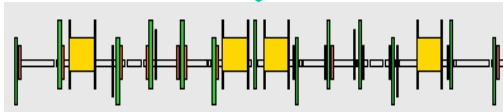
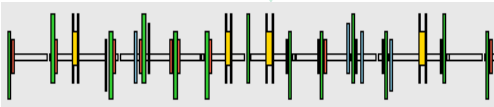

Redesign the lattices of HER & LER to squeeze the emittance

TiN-coated beam pipe with antechambers

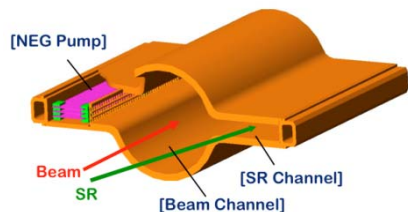

Add / modify RF systems for higher beam current



Low emittance positrons to inject

Damping ring



Positron source

New positron target / capture section



Low emittance gun

Low emittance electrons to inject

**To get x40 higher interaction rate**



# Need to build a new detector to handle higher backgrounds

Critical issues at  $L = 8 \times 10^{35}/\text{cm}^2/\text{sec}$

▶ **Higher background (  $\times 10\text{-}20$  )**

- radiation damage and occupancy
- fake hits and pile-up noise in the EM

▶ **Higher event rate (  $\times 10$  )**

- higher rate trigger, DAQ and computing

▶ **Require special features**

- low  $p \mu$  identification  $\leftarrow s_{\mu\mu}$  recon. eff.
- hermeticity  $\leftarrow \nu$  "reconstruction"

Have to employ and develop very advanced technologies to build such an apparatus!

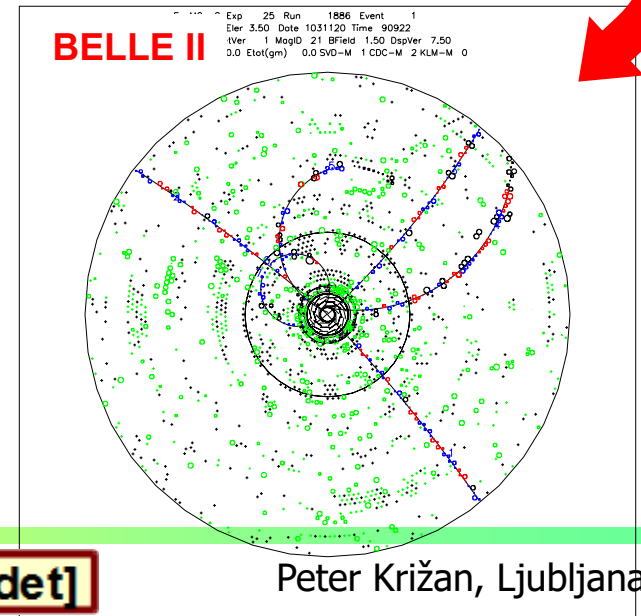
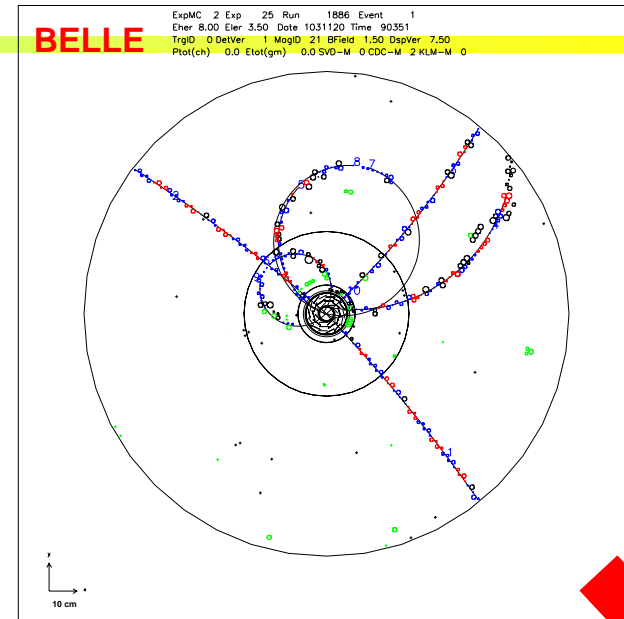

TDR published [arXiv:1011.0352v1](https://arxiv.org/abs/1011.0352v1) [physics.ins-det]

Peter Križan, Ljubljana



# Belle II Detector

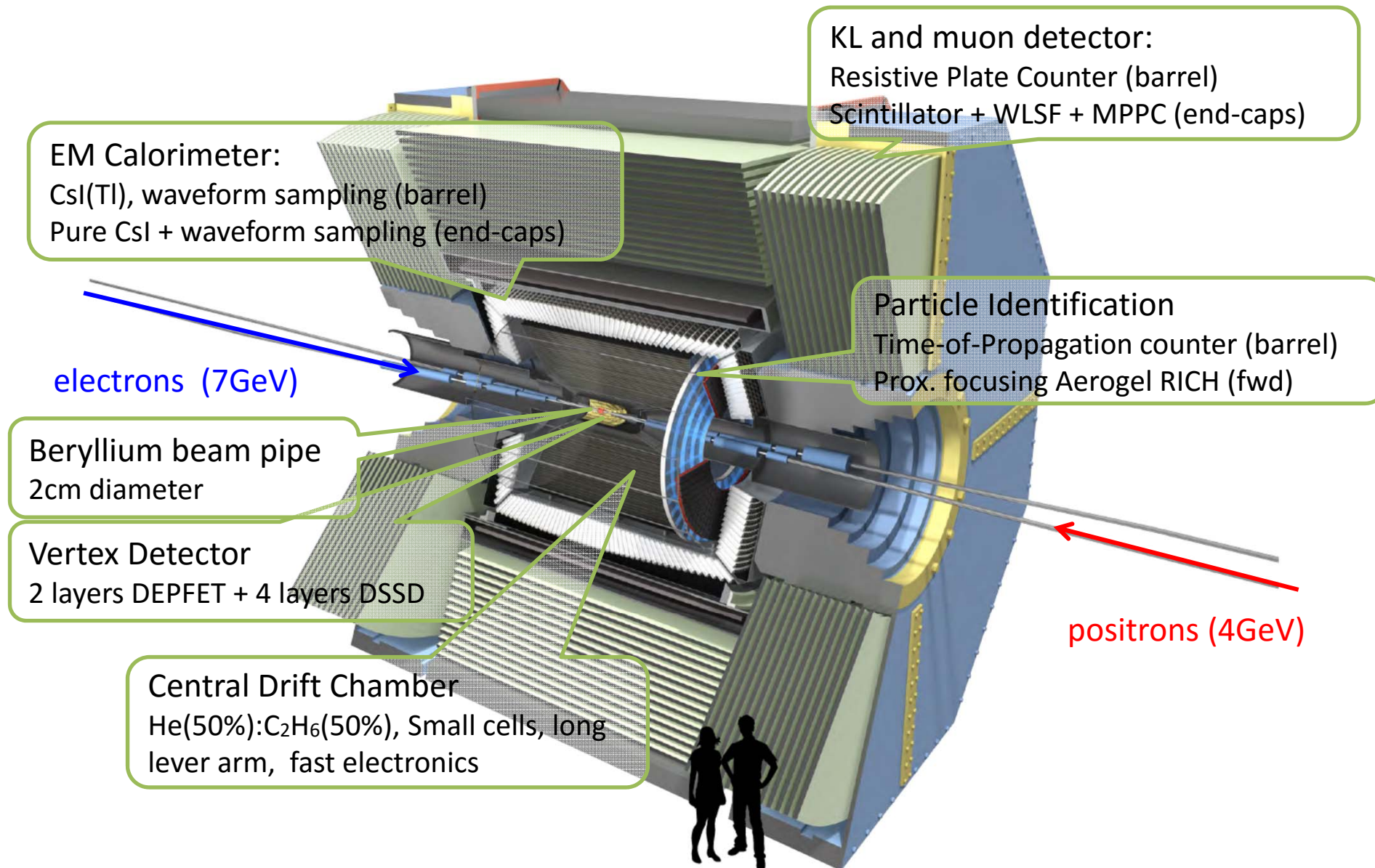





Tracking charged particles in magnetic field – measure their momenta

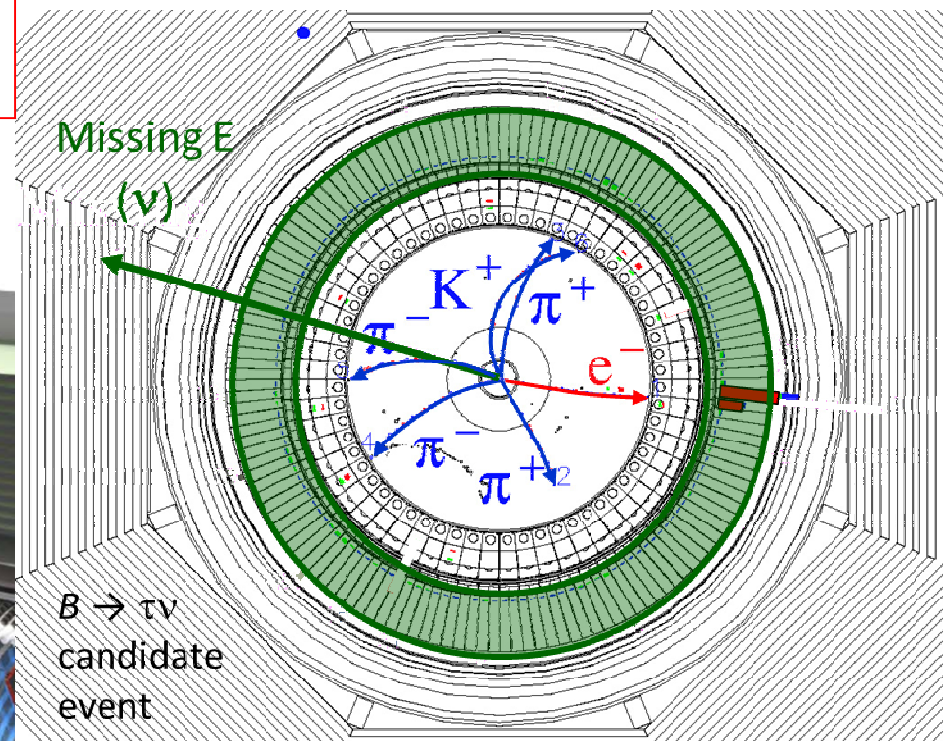
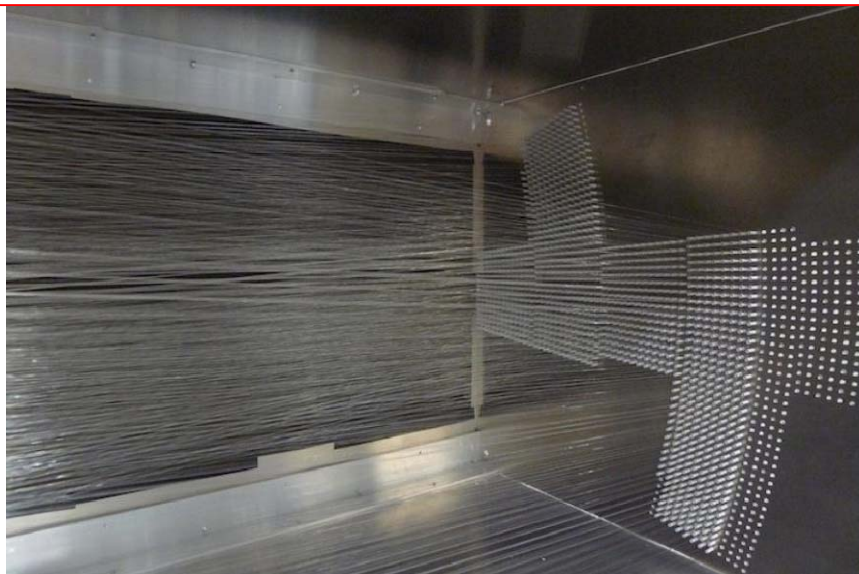

Central Drift Chamber  
He(50%):C<sub>2</sub>H<sub>6</sub>(50%), Small cells, long lever arm, fast electronics





Use **Cherenkov effect**: light emitted by a particle **faster than velocity of light** in a medium - like a **shock wave** from a **supersonic airplane**!

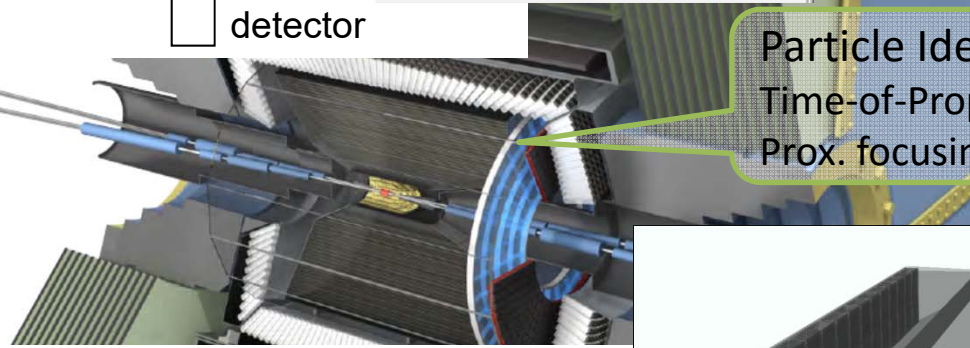
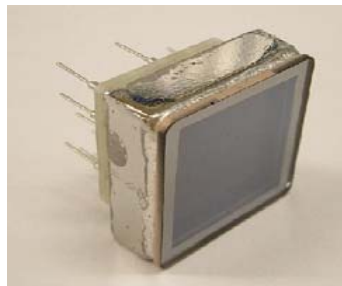
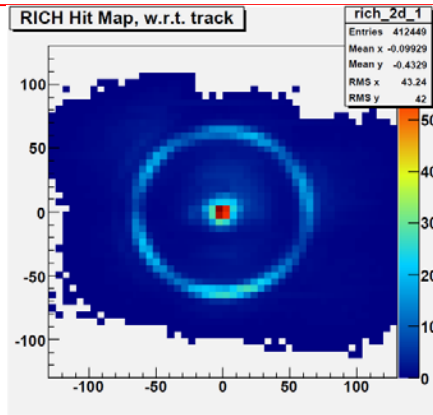
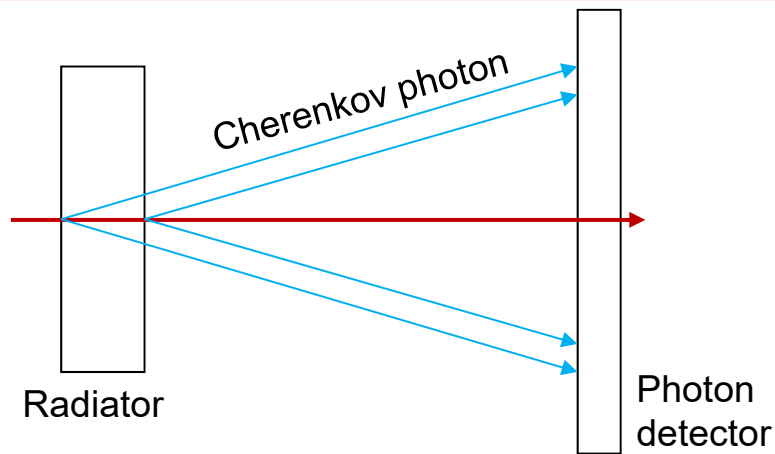

Particle Identification  
Time-of-Propagation counter (barrel)  
Prox. focusing Aerogel RICH (fwd)

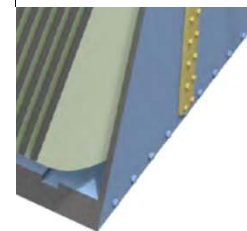
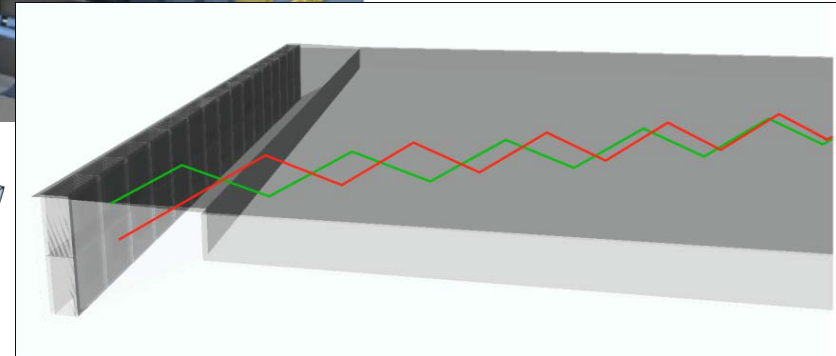
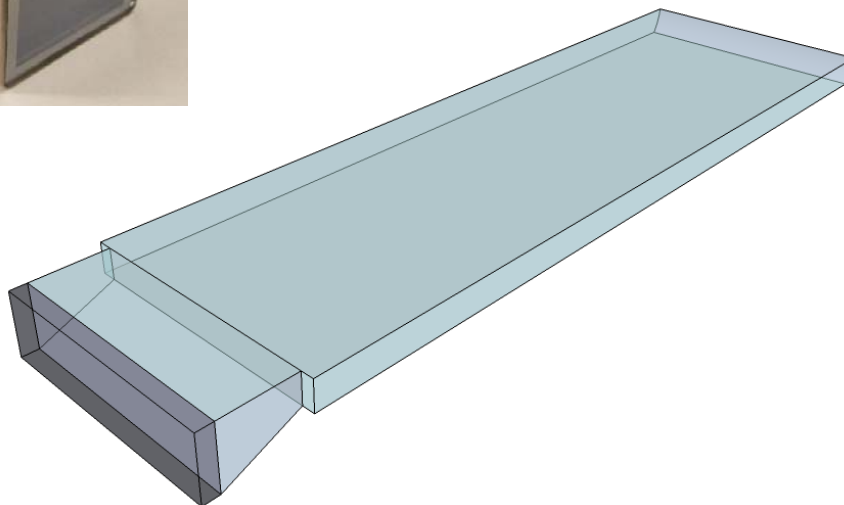

Detect **electrons** and high energy **gamma rays** by letting them produce a **shower** in a **heavy crystal**

EM Calorimeter:

CsI(Tl), waveform sampling (barrel)

Pure CsI + waveform sampling (end-caps)

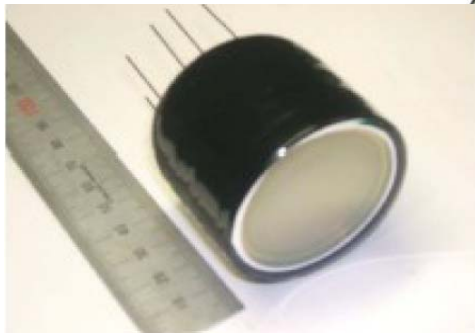
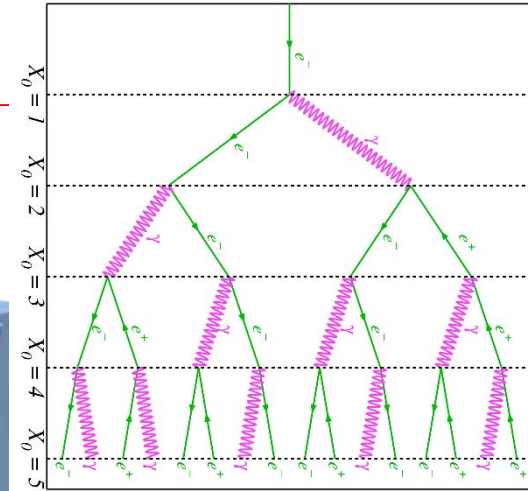



# Detect **muons**: particles that **penetrate 1m of iron**

KL and muon detector:  
 Resistive Plate Counter (barrel)  
 Scintillator + WLSF + MPPC (end-caps + barrel)

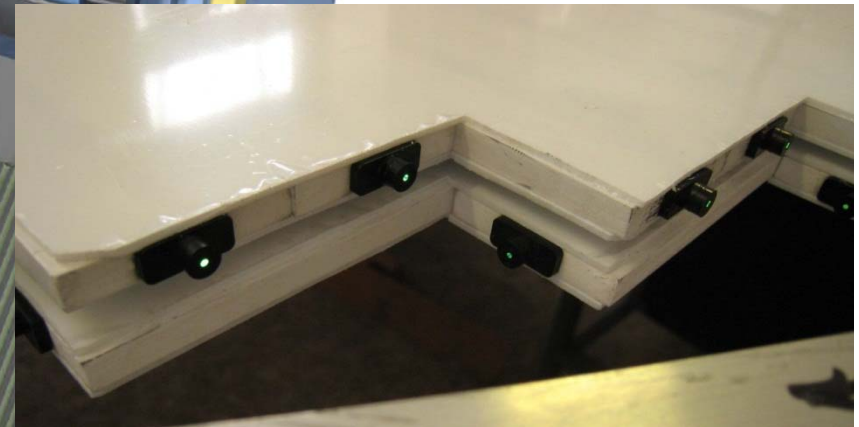
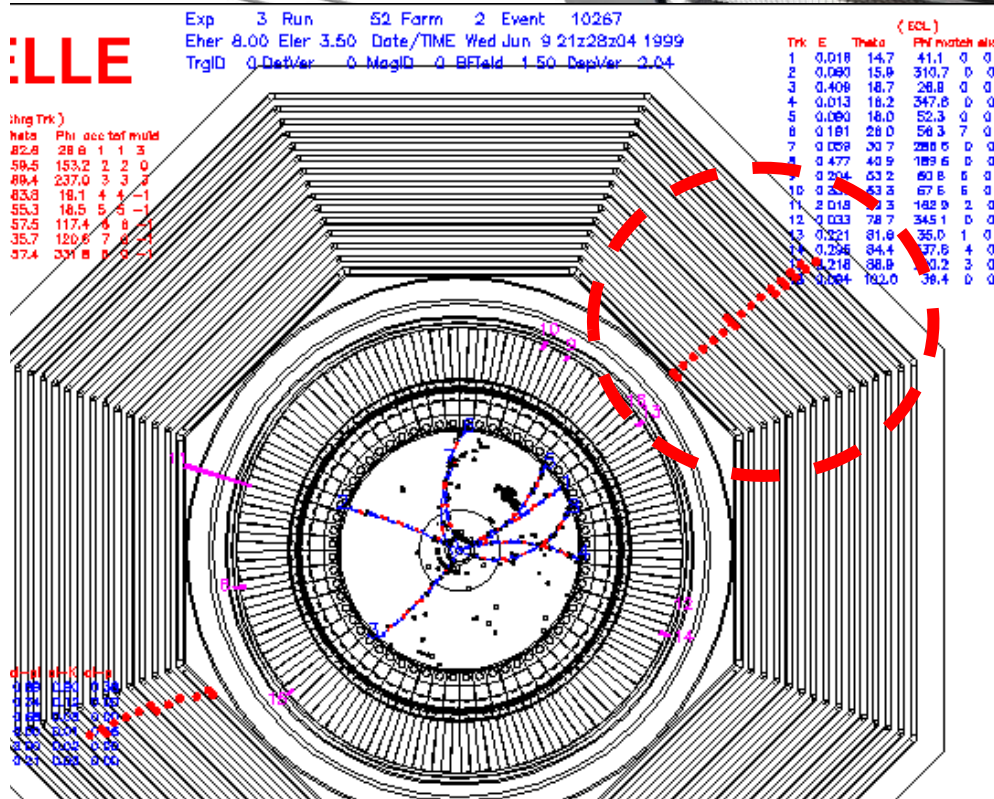
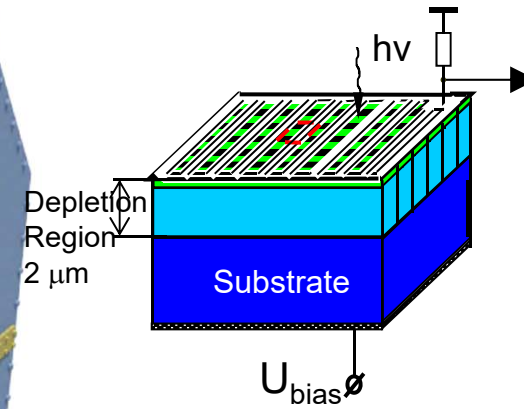
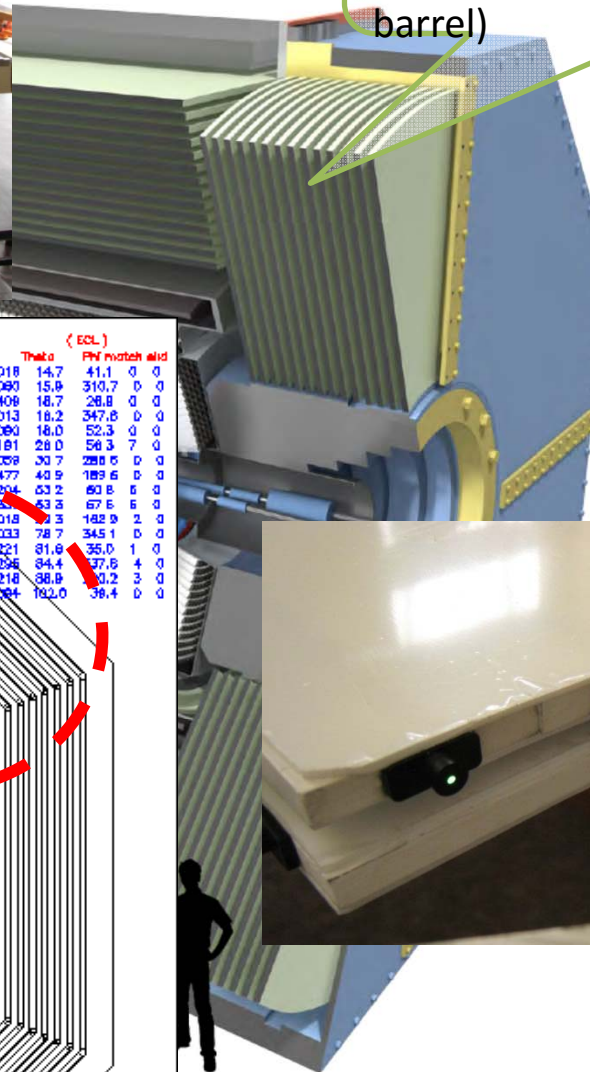
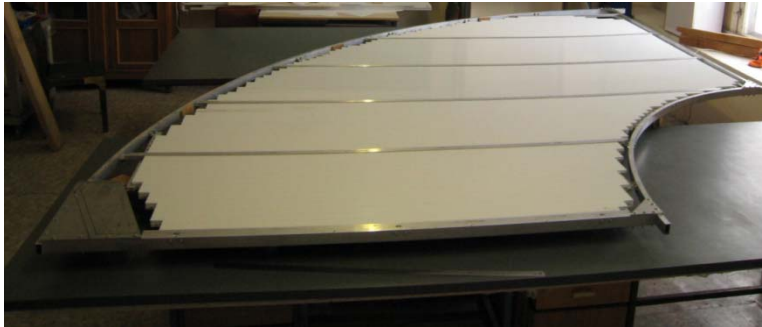

Again: this project would not be possible without a strong international collaboration!



Even a single detector system requires a broad international collaboration!

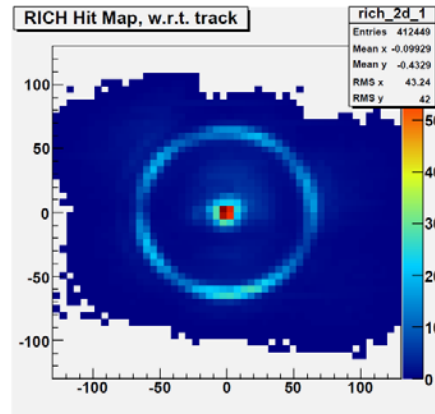
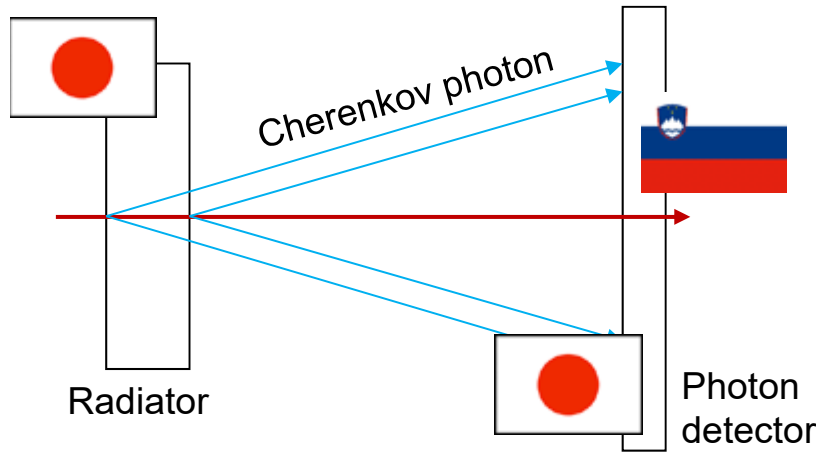

Particle Identification  
Time-of-Propagation counter (barrel)  
Prox. focusing Aerogel RICH (fwd)

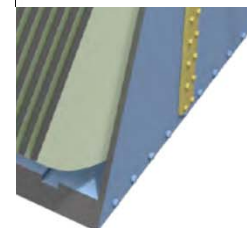
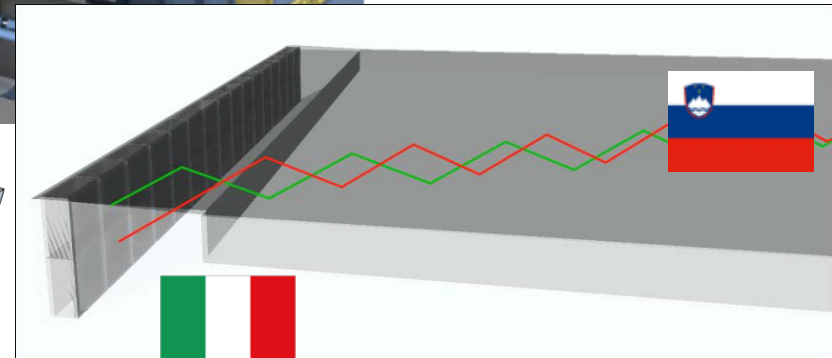
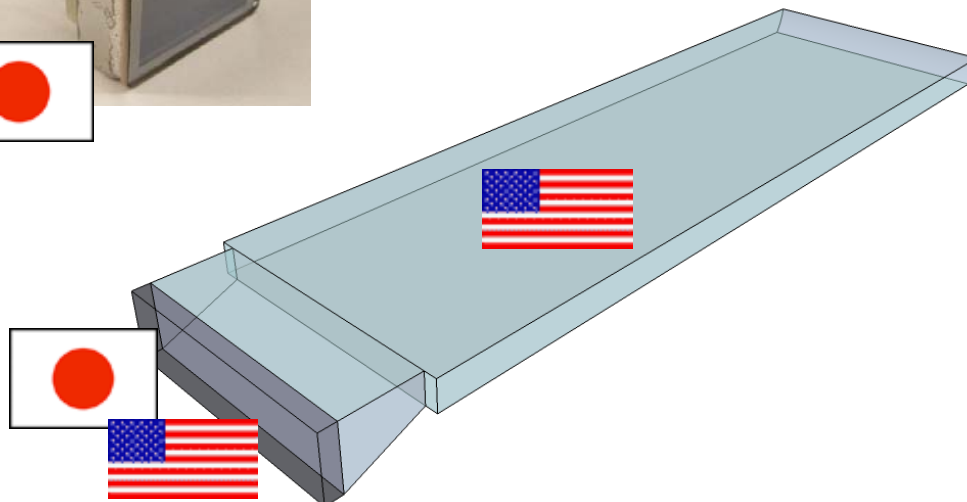
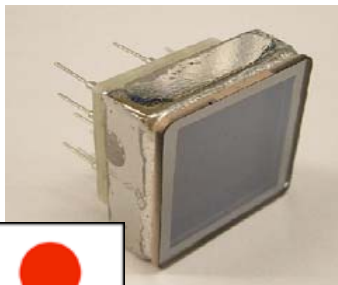



# Huge data samples @ Belle II: We need distributed computing resources

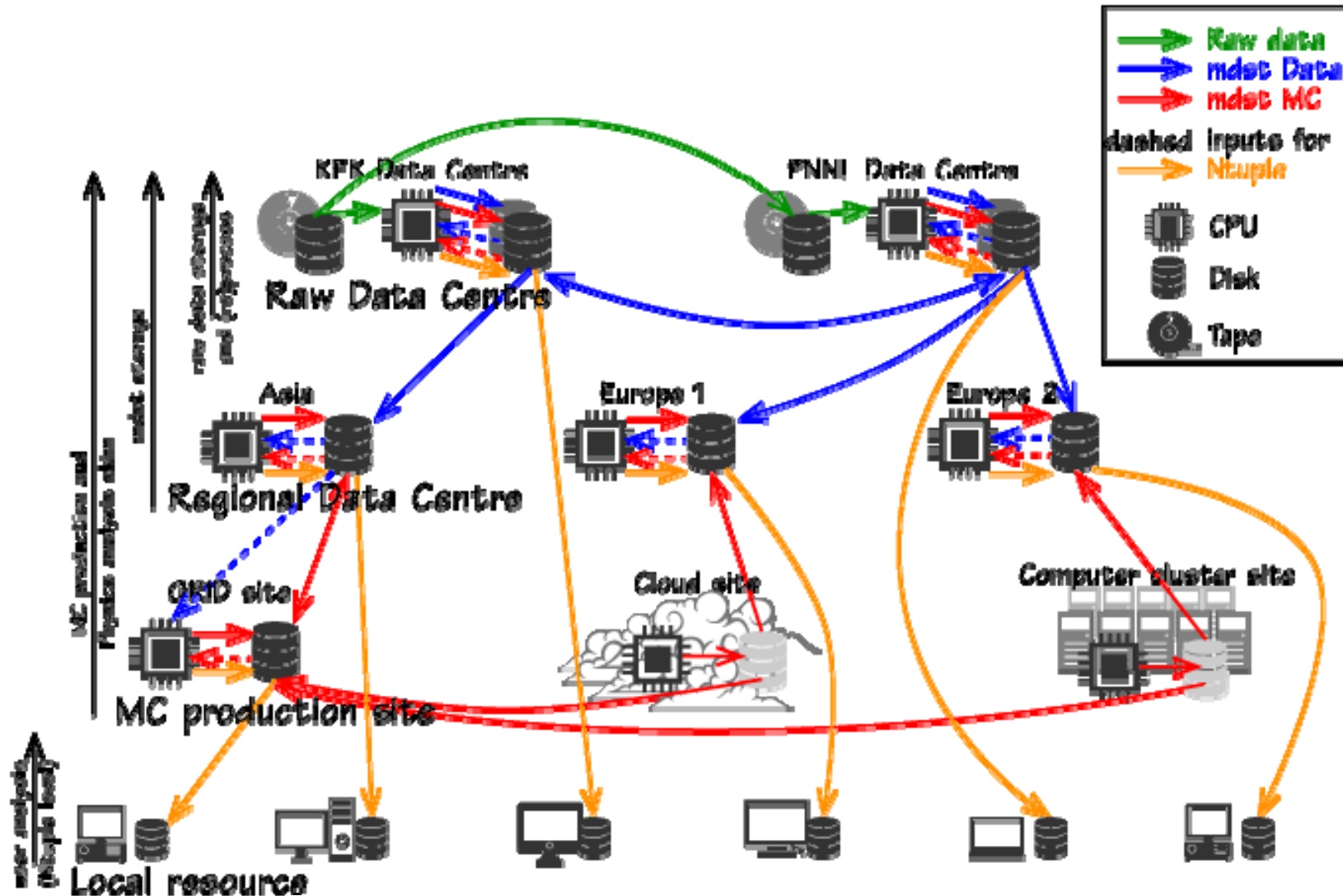



# Simulated data campaign in October 2014

## Total Number of Jobs by Site

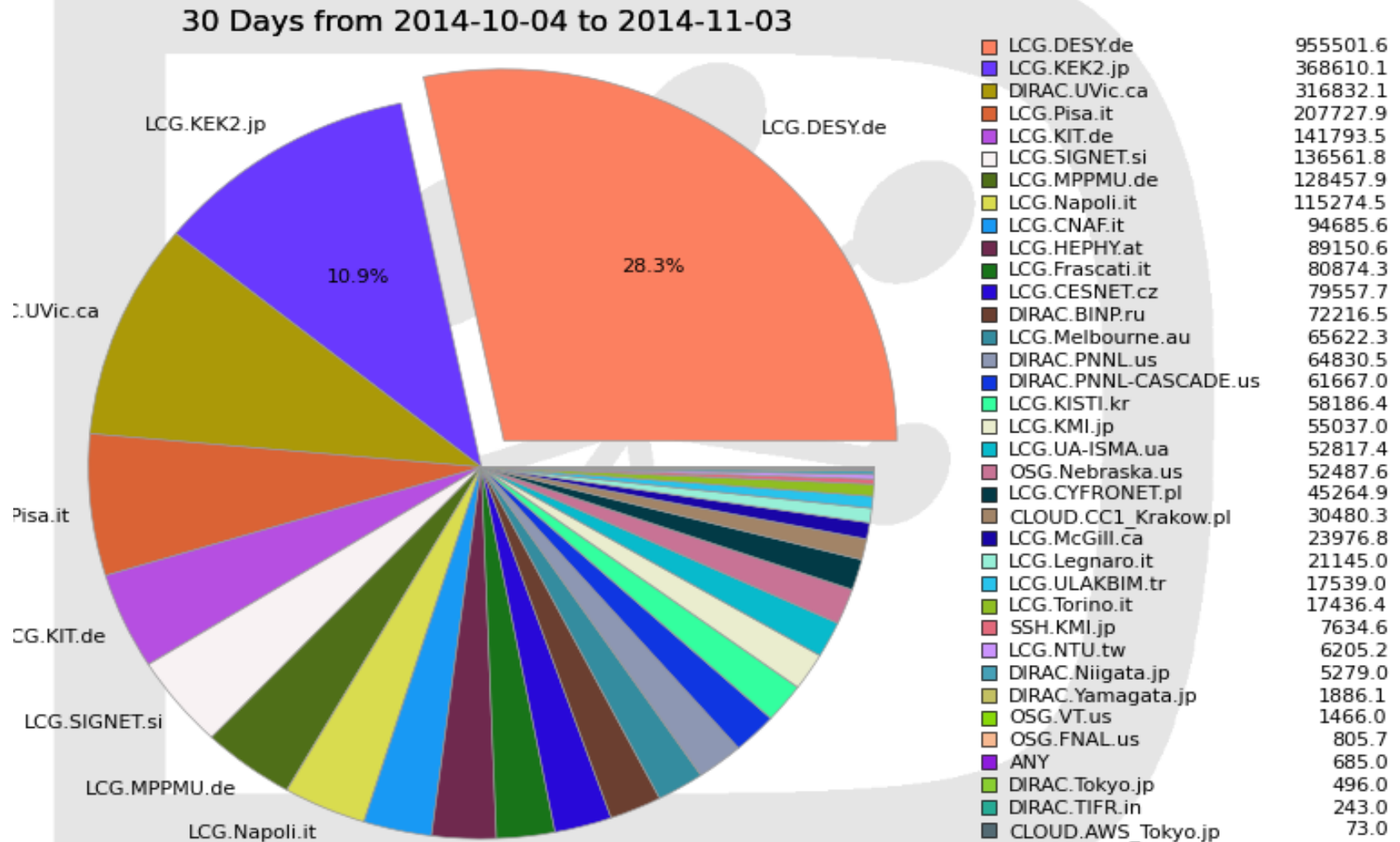

# The Belle II Collaboration



A very strong group of  $\sim 600$  highly motivated scientists!

# SuperKEKB luminosity projection

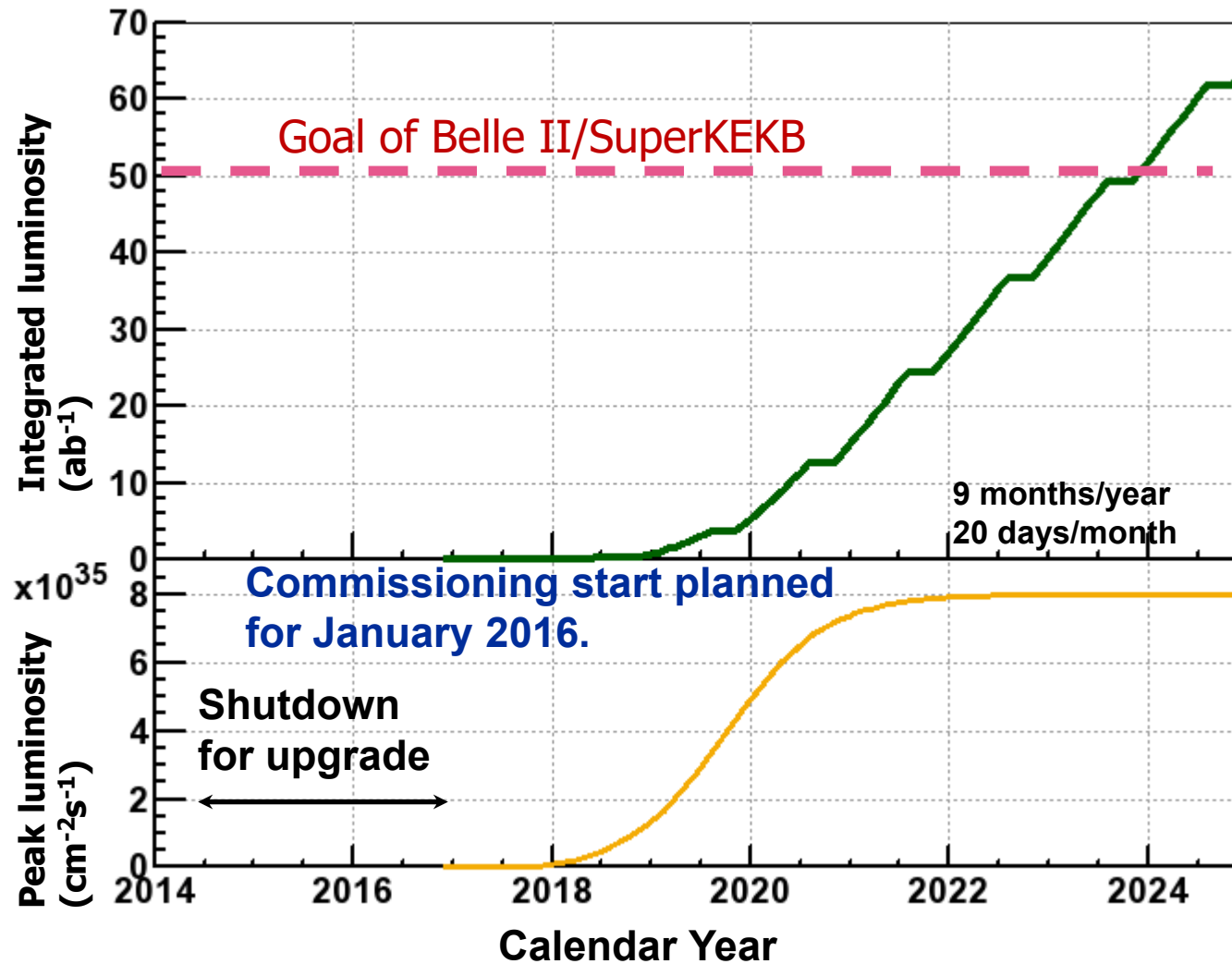



# Collaboration in numbers...

- 600 collaborators
- ~60 institutions (universities and institutes)
- 20 countries
- ~25 different funding agencies (ministries, agencies)
- Several dramatically different working cultures
- 8 time zones
- 9 different detector systems

How to get organized?

Formally a very loose structure (collaborating scientists are employed by their home institutions, the leader of the experiment (spokesperson) is not a director)





## Some typical challenges:

- 600 collaborators → a number of different personalities
- ~60 institutions (universities and institutes) → each group has its own leader, and the leader, in turn, has his boss in the home institution
- 20 countries, ~25 different funding agencies (ministries, agencies) → different ways and cycles of funding
- Several considerably different working cultures → Japanese work very long hours, scientists from US are used to fierce discussions
- 8 time zones → impossible to find a time slot for a phone conference that would suit everybody – for some it will always be in the middle of the night...

Sun never sets in the Belle II Collaboration...

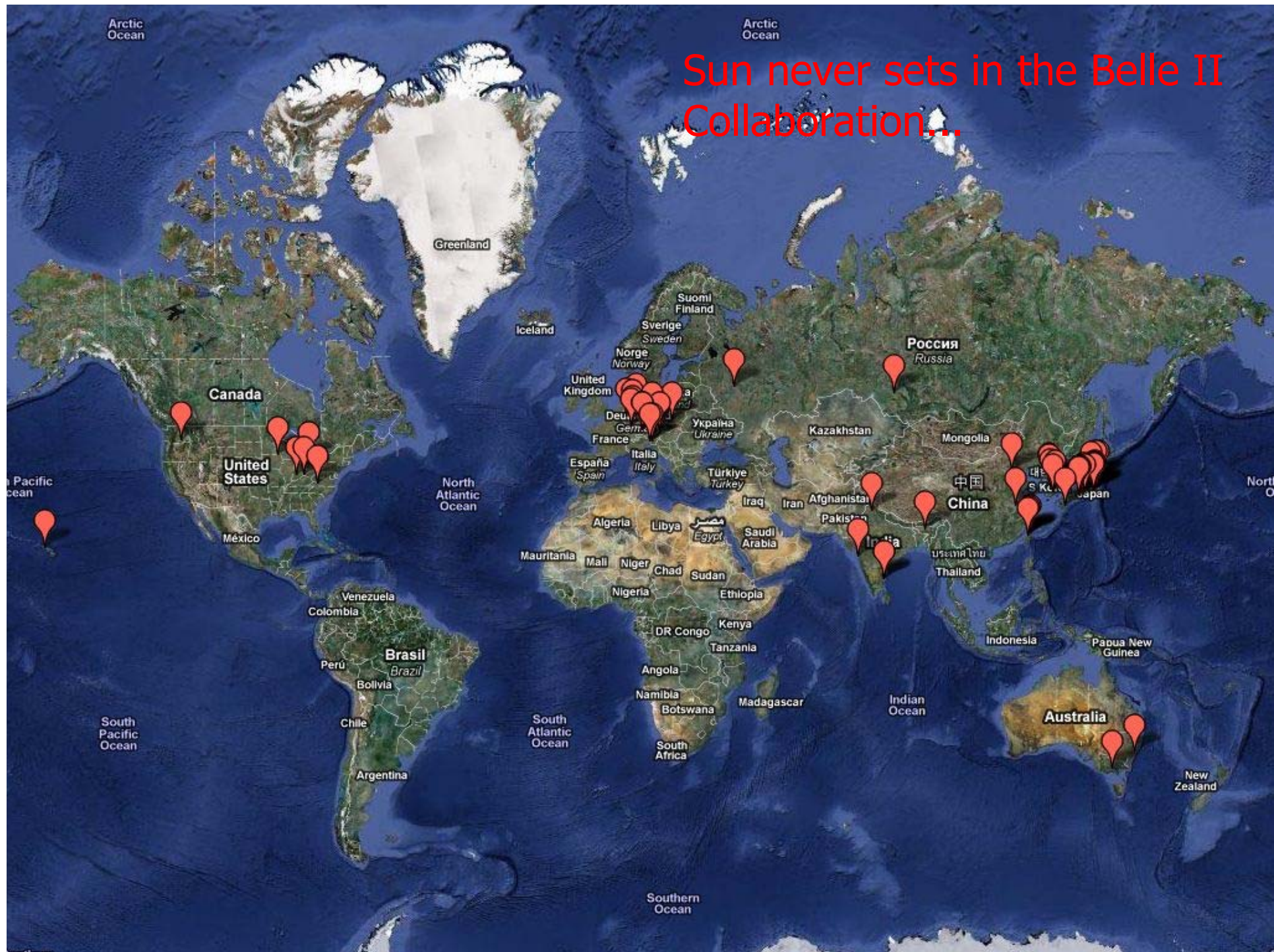





## Some typical challenges 2:

- **9 different detector systems** → different, sometime conflicting requirements, different detector preparation methods
- **Formally a very loose structure:** collaborating scientists are employed by their home institutions, the leader of the experiment (spokesperson) is not a director → planning of various aspects of the project cannot be carried out by the project top management alone; same is true for the task sharing



# Why and how does this work at all?

In this field of science working in large international research groups has a half a century long tradition. Large-scale experiments cannot be carried out even by a single country, let alone by a single research group.

Research groups and individual researchers are highly motivated: they know that one without the other can not succeed. The success of the whole collaboration is crucial for the promotion of individual scientists involved in the project, and for early stage researchers it facilitates the path to a permanent job...

Such a large international research group is formed on a voluntary basis: individual groups either join forces in the preparatory phase of the project, or are in a later stage of the project identified as suitable candidates, and invited to join.



# Success is not guaranteed...

Caveat: projects sometimes fail:

- ...sometimes because the physics goal was not well chosen or other experiments were faster or the relevance of the research faded while the project was under preparation → not bad, a good lesson for the next experiment! After all, this is just like in sport, you cannot always win!
- ...sometimes because wrong people came together - this is not so nice, and not particularly useful as an experience...

# Organisational structures

Clearly, such a group needs some organization to function.

This is a typical structure:

- **Spokesperson** leads the group (elected for a fixed term, often renewable)
- **Executive board** helps in the day-to-day decisions.
- **Institutional board**: highest body of a collaboration, with representatives from each of the collaborating institutions.
- **Coordinators**: physics, technical (detector), software, computing: coordination of the work of sub-detector leaders and working group leaders.

# Belle II Organization

## Executive Board

**Chair : H. Aihara**  
aihara@phys.s.u-tokyo.ac.jp

D.M.Asner, T.Aziz, A.Bozek, P.Chang,  
F.Forti, T.Iijima, P.Krizan, S.Lange,  
P.Podesta, M.Roney, C.Schwanda,  
M.Sevior, E.Won, C.Z.Yuan, K.Akai

## Financial Board

**Chair : Y.Sakai**  
Yoshihide.Sakai@kek.jp

W.Abdullah, H.Aihara, D.Asner, R.Ayad, T.Aziz,  
A.Bozek, T.Browder, P.Chang, Z.Dolezal,  
G. Finocchiaro, P.Krizan, C.Lacasta, M.I.Martinez,  
H.G.Moser, C.Nieber, P.Pakhlov, A.Rekalo,  
M.Ronie, C.Schwanda, M.Sevior, C.P. Shen,  
U.Tippawan, T.Tran, N.Wermes, E.Won, M.Zeyre

**Spokesperson : Thomas E. Browder**

teb@phys.hawaii.edu

**Project Manager : Yoshihide Sakai**

Yoshihide.Sakai@kek.jp

## Institutional Board

**Chair : Z.Dolezal**  
dolezal@ipnp.troja.mff.cuni.cz

## Speakers Committee

**Chair : A.Schwartz**  
alan.j.schwartz@uc.edu

T.Iijima, I. Peruzzi, Y.Sakai, C.Schwanda

## Physics

### Coordinator

**: P.Urquijo**  
purquijo@unimelb.edu.au

**Semileptonic & Missing Energy**  
: A. Zupanc, G. De Nardo  
**Radiative & Electroweak Penguin**  
: A. Ishikawa, J. Yamaoka  
**T-Dep. CP Violation**  
: T. Higuchi, L. Li Gioi  
**Hadronic B Decay & DCPV**  
: J. Libby, P. Goldenzweig  
**Quarkonium** : R. Mizuk, T. Pedlar  
**Charm** : R. Briere, G. Casarosa  
**Tau & Low Multiplicity**  
: K. Hayasaka, T. Ferber

## Technical

### Coordinator

**: Y.Ushiroda**  
ushiroda@post.kek.jp

**Integration Leaders : I. Adachi (Outer)**  
**S. Tanaka (Inner)**

**PXD** : H.G. Moser  
C. Kiesling  
**SVD** : C. Schwanda  
(deputy : T. Higuchi)  
**CDC** : S. Uno  
**TOP** : J. Fast  
(deputy : T. Iijima)  
**ARICH** : S. Nishida  
S. Korpar  
**ECL** : A. Kuzmin  
**EKLM** : P. Pakhlov  
**BKLM** : L. Piilonen  
**TRG** : Y. Iwasaki  
**DAQ** : R. Itoh  
**IR** : H. Nakayama  
**STR** : J. Haba  
**BKG** : S. Vahsen  
(deputy : H. Nakayama)  
**Liaisons** :  
S. Tanaka (PXD)  
T. Tsuboyama (SVD)  
I. Adachi (BPID)  
I. Nakamura (ECL)  
K. Sumisawa (BKLM/EKLM)

## Software

### Coordinator

**: T.Kuhr**  
Thomas.Kuhr@lmu.de

**Generators** : T.Ferber  
**Simulation** : D. Kim  
**Background** : M. Staric  
**Tracking** : M. Heck, E. Paoloni  
**Alignment & Calibration**  
: S.Yashchenko  
**Database** : M. Bracko  
: L. Wood

## Computing

### Coordinator

**: T.Hara**  
takanori.hara@kek.jp

**Distributed Computing Architecture**  
: I. Ueda  
**Network / Data Management**  
: M. Schram  
**Production System** : H. Miyake  
**Monitor** : K. Hayasaka  
**Data Processing** :  
**Training** :

# Organisation, continued

Financial aspects are discussed in the **Financial board** (in some collaboration this is the job of a Resource committee).

External bodies:

- **International advisory committee** (at Belle II: BPAC) internationally recognized experts on detectors and physics topics of the experiment
- **Financial oversight panel** (FOP): representative of funding agencies involved in the project
- **Scrutiny Committee**: a small body of independent experts from major contributing nations, checks the expenses for the maintenance and operation.

Rules of how to operate ('bylaws') are set by the Collaboration Board.



# Organisation, continued

In most experiments, there are similar structures.

→ ATLAS

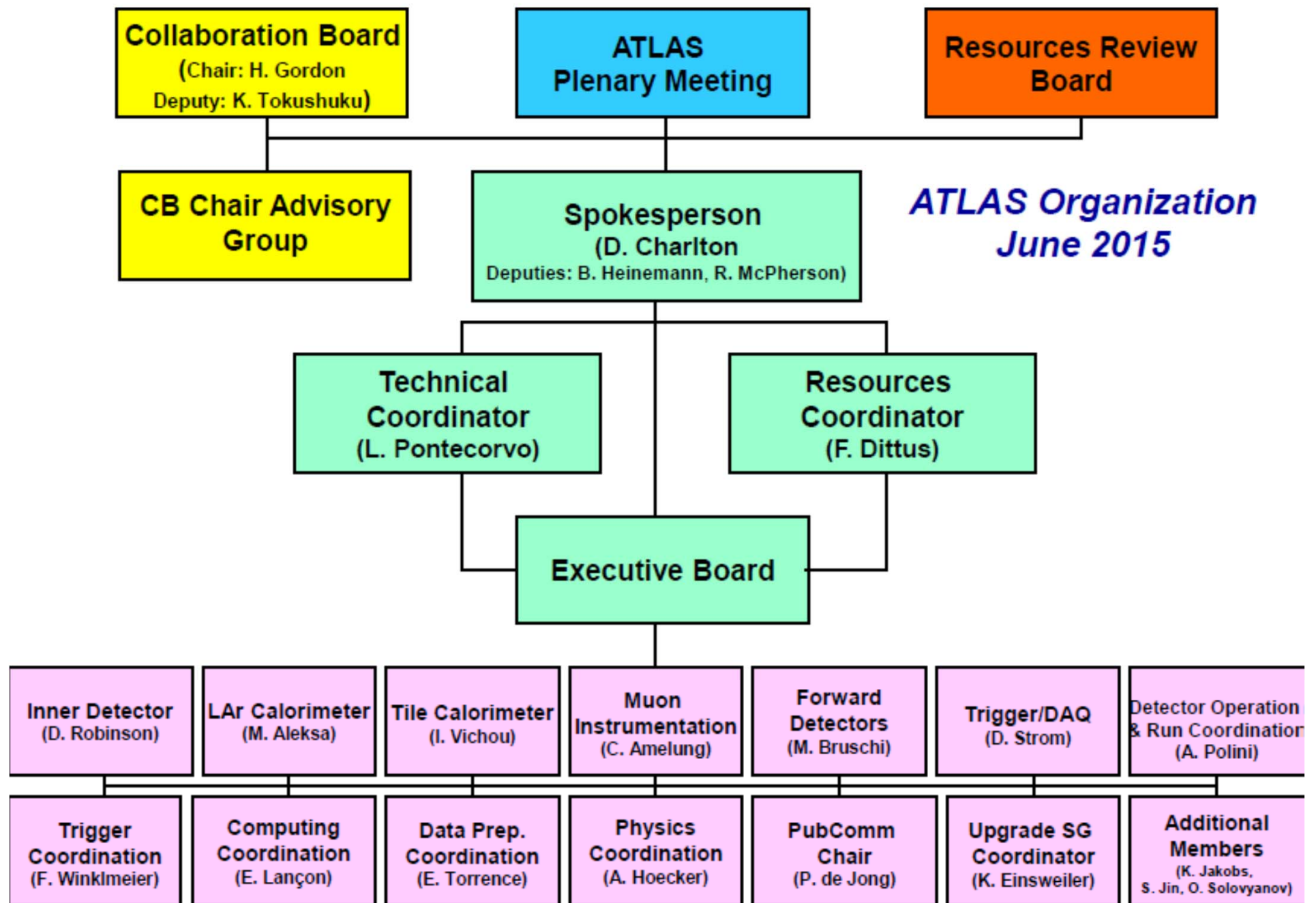



# Summary



- In particle physics, working in large international research groups has a long tradition. Large-scale experiments cannot be carried out even by a single country, let alone by a single research group.
- Research groups and individual researchers are highly motivated to collaborate in the team: they know that one without the others can not succeed. The success of the whole collaboration is crucial for the promotion of individual scientists involved in the project.
- Still, some organizational structures are needed to steer the project.
- At KEK in Tsukuba a major upgrade is under way since 2010, to resume operation in 2016 → SuperKEKB+Belle II, with **40x larger** event rates.
- Expect a new, exciting **era of discoveries**, complementary to the LHC