

WISS 2020

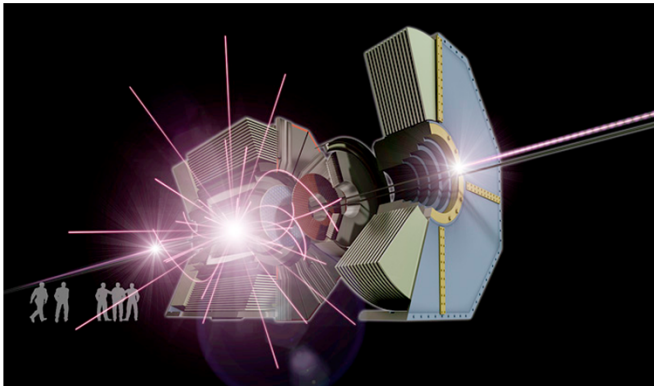

Recent advances in detectors

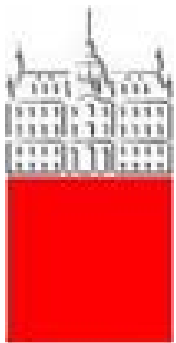

Peter Križan

University of Ljubljana and J. Stefan Institute



Contents

Introduction

New sensors for tracking (and vertexing)

Particle identification

Low level light sensors

A very broad topic for a single talk – very hard to cover all interesting developments → Some subsample, also partly reflecting my own interests, hopefully broad enough to be interesting for everybody

Nov 16-18, 2020

Where are we?

Intensity frontier:

- Belle II started taking data
- LHCb is being upgraded

Energy frontier:

- ATLAS and CMS are getting ready for a major upgrade in the next long shut-down
- ALICE is being upgraded

Electron-ion collider experiments:

- Preparation with a very tight schedule

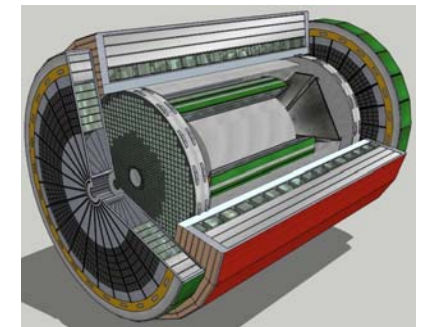
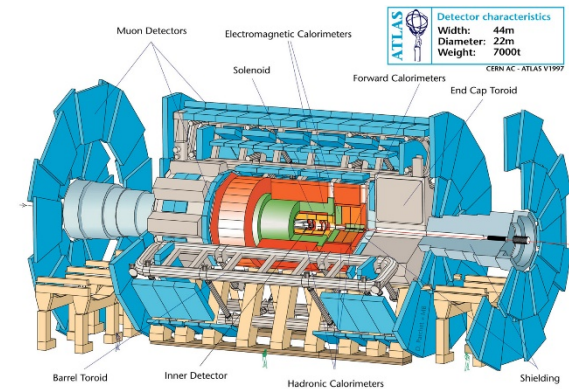
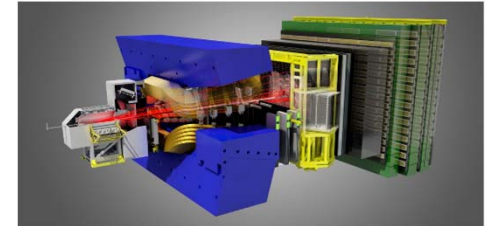
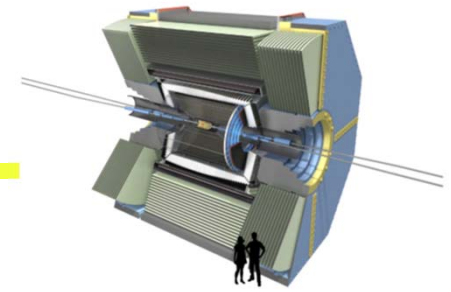

Tracking (and vertexing)

Various needs:

- Lower energies (Belle II): precision tracking and minimal multiple scattering, few particles in the final state, no event overlap
- LHC: precision with a high density of particles, multiple overlaid interactions within the same event, high radiation load

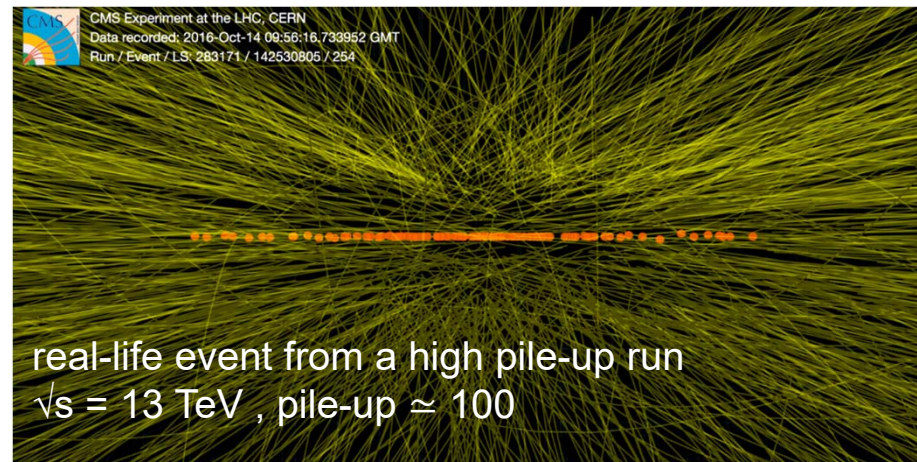
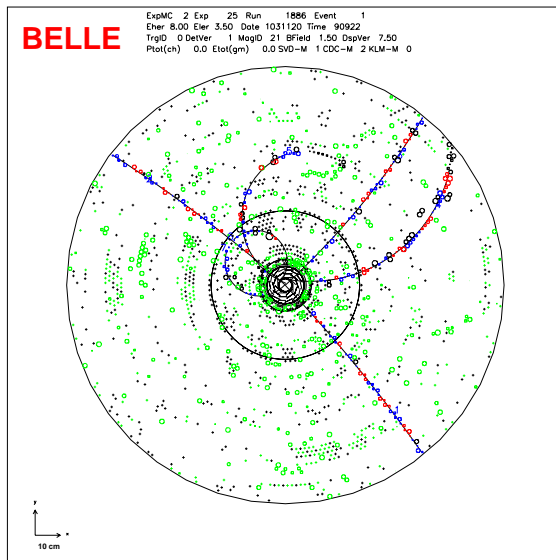

Vertexing at Belle II:

Momenta of charged particles from B meson decays: $p < 4 \text{ GeV}/c$

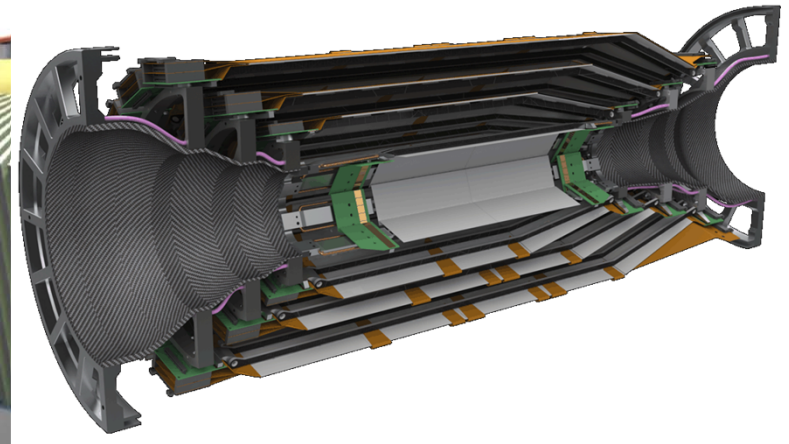

Beryllium beam pipe
2cm diameter

Vertex Detector
2 layers pixels + 4 layers strips

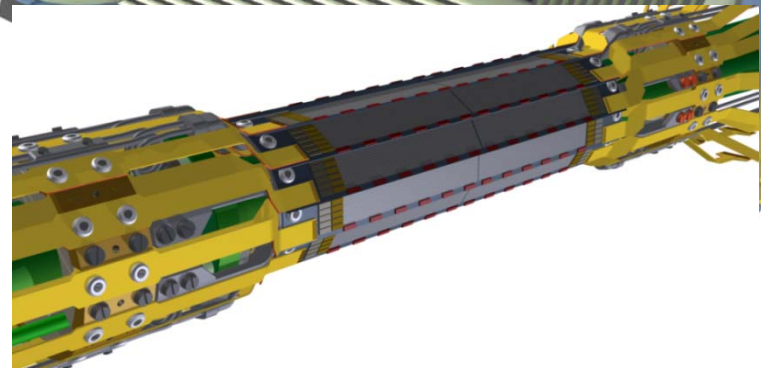
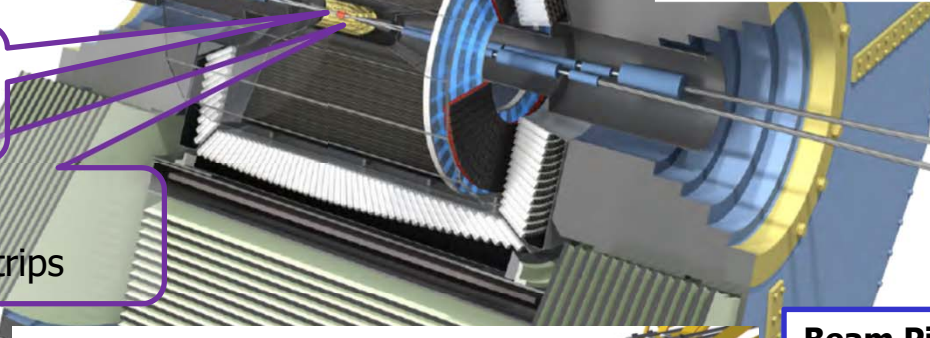

Beam Pipe	r = 10mm
DEPFET pixels	
Layer 1	r = 14mm
Layer 2	r = 22mm
DSSD silicon strips	
Layer 3	r = 39mm
Layer 4	r = 80mm
Layer 5	r = 104mm
Layer 6	r = 135mm

Pixel detector: 2 layers of DEPFET sensors

DEpleted P-channel FET

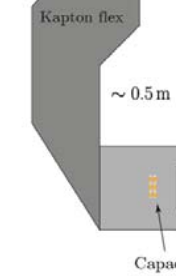
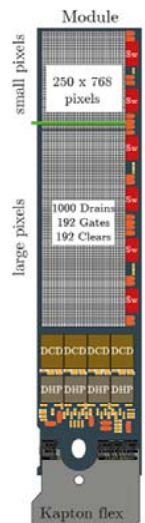
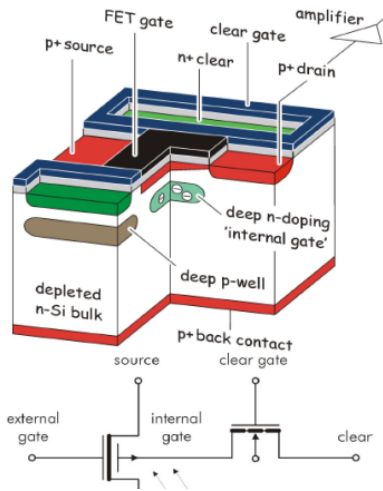

Optical transmitter Dock Box

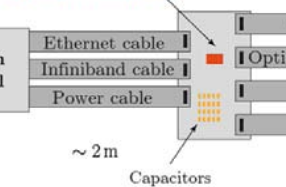

	L1	L2
# ladders (modules)	8 (16)	12 (24)
Distance from IP (cm)	1.4	2.2
Thickness (μm)	75	75
#pixels/module	768x250	768x250
#of address and r/o lines	192x1000	192x1000
Total no. of pixels	3.072×10^6	4.608×10^6
Pixel size (μm^2)	55x50 60x50	70x50 85x50
Frame/row rate	50kHz/10MHz	50kHz/10MHz
Sensitive Area (mm^2)	44.8x12.5	61.44x12.5

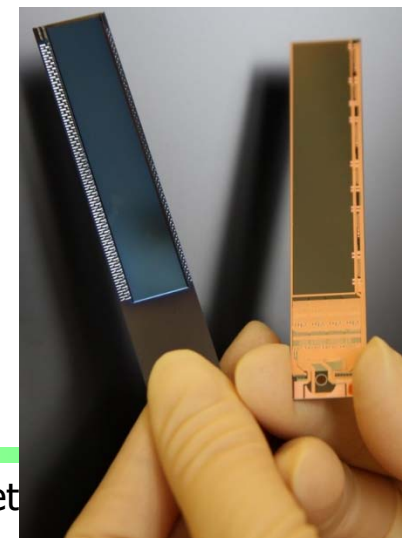
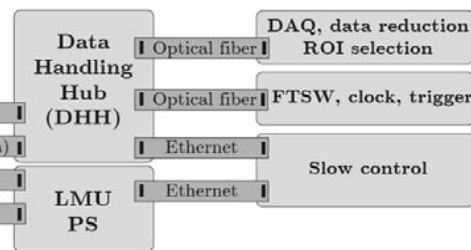

Pet

Key R&D aspects for Belle II PXD

- Low-mass modules
 - Unique all-silicon module, self-supporting 75 μm thin silicon \rightarrow 0.2% X_0
 - Active pixel sensor \rightarrow amplification of signal from thin silicon
 - Low power dissipation in sensitive area
- Dedicated read-out ASICs
 - Three types of ASICs (DCD, DHP, Switcher)
 - Fast front-end ASIC allowing fast read-out for acceptable occupancy
 - On-module data reduction
- Module assembly procedure
 - All assembly steps compatible with low-mass modules
- Low-mass support structures within the sensitive volume and efficient thermal management \rightarrow CO₂ cooling

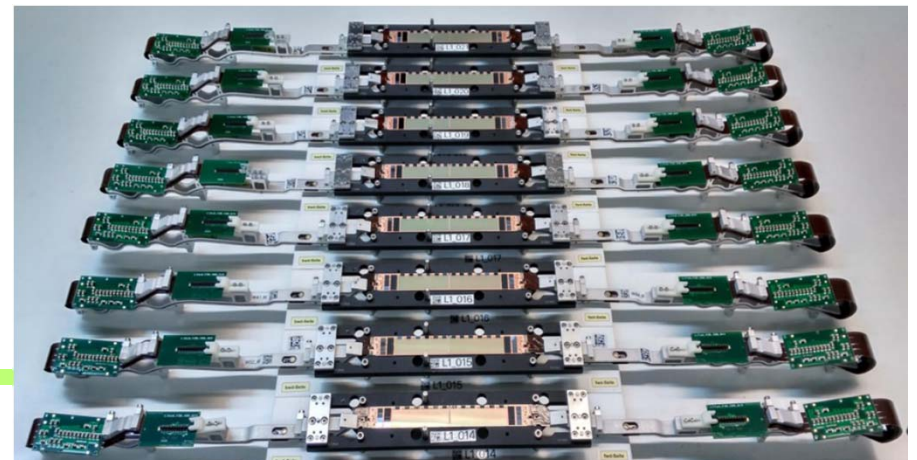

SVD: four layers of double sided silicon strip detectors.

Main R+D areas:

Origami chip-on-sensor concept (readout chips on top of the sensors with flex pitch adapters bent around the edge to reach the bottom sensor side) for good S/N with fast readout and moderate material budget

Excellent time resolution ($\sim 4\text{ns}$) thanks to multiple recorded samples and waveform fitting

CO₂ dual-phase cooling

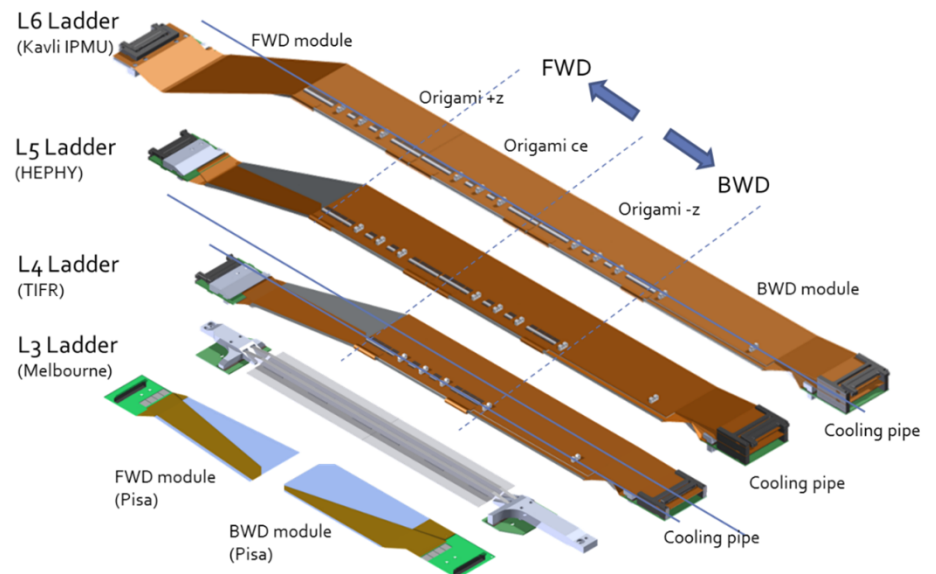
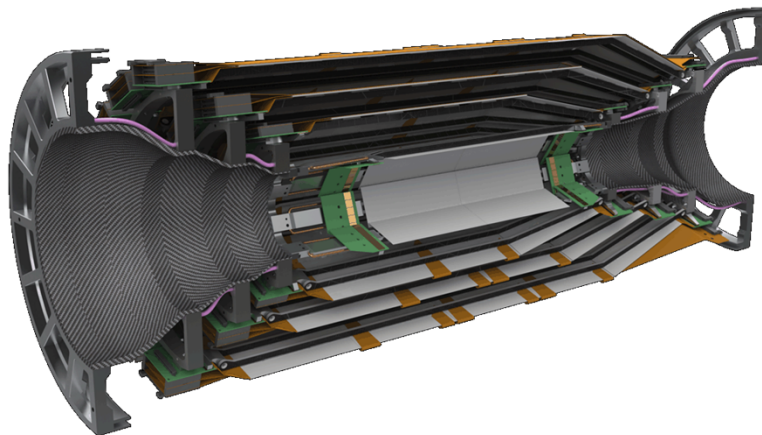

Belle II vertex detector in action

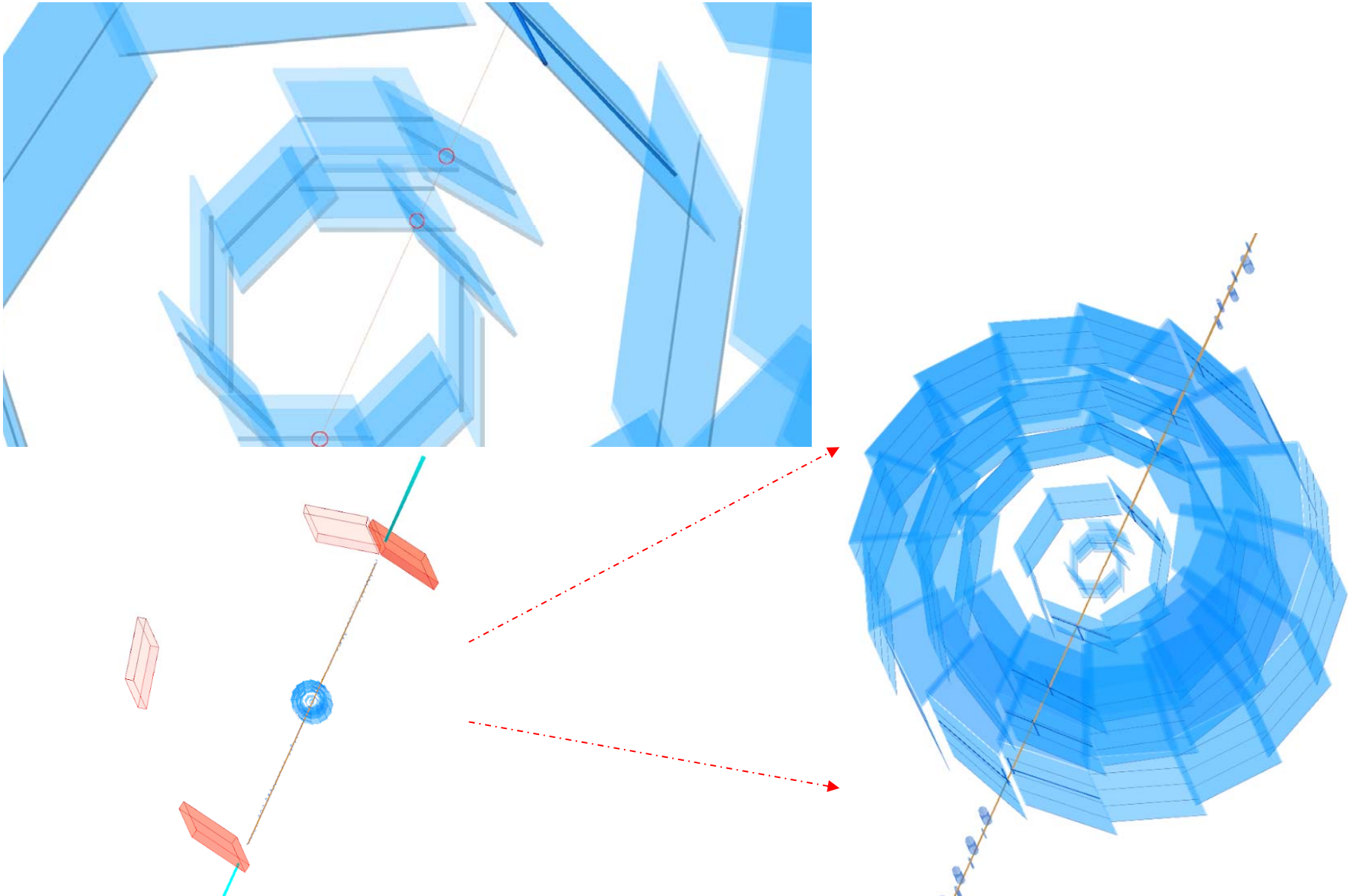

LHCb Upgrade: in progress

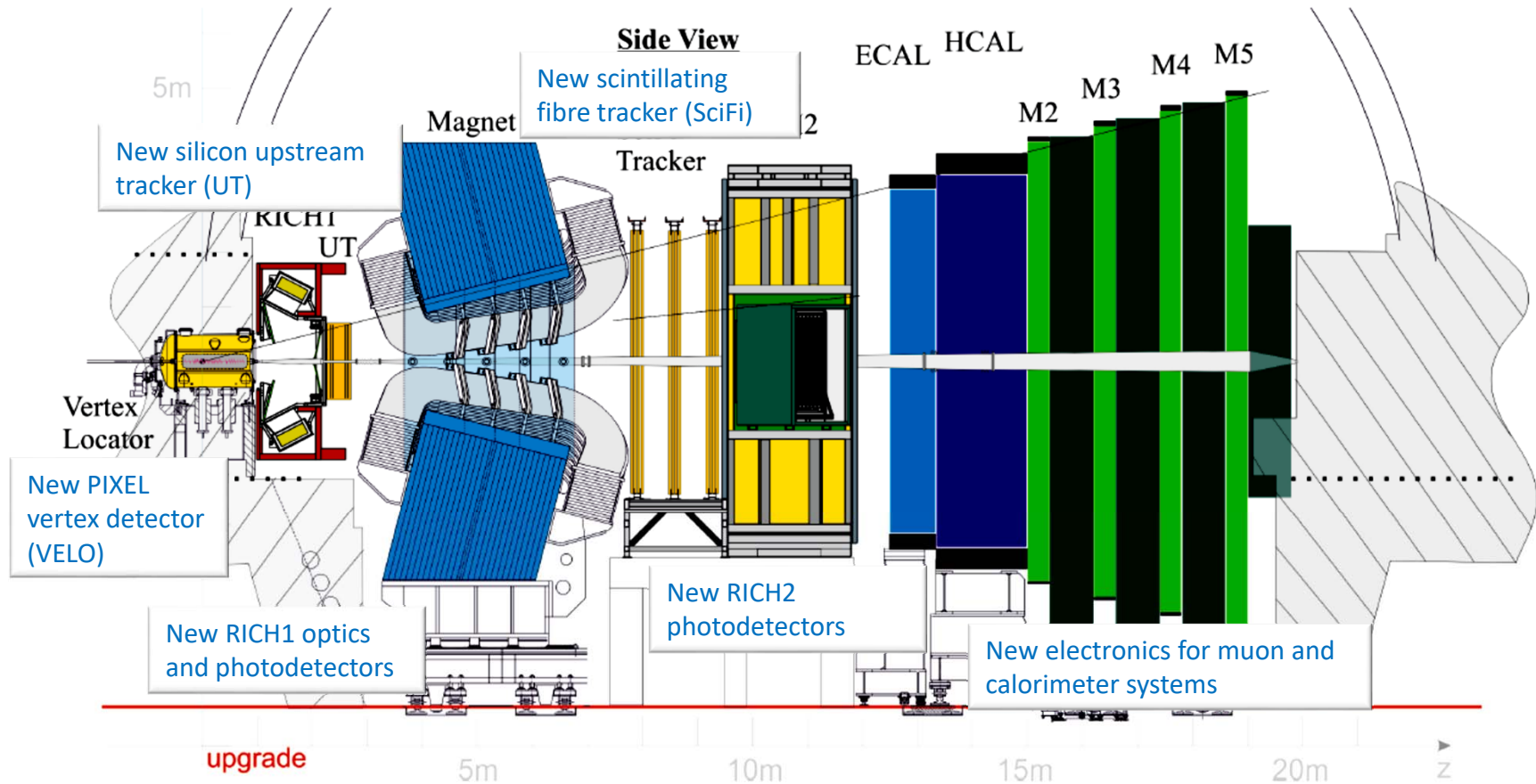

- 50 fb^{-1} , $2 \times 10^{33} \text{ cm}^{-2} \text{ s}^{-1}$
- All front-end electronics read out at 40 MHz
- 30 MHz avg. input to a full software trigger

LHCb Vertex LOcator upgrade

The upgraded VELO is being installed to take data in Run III Operation @ 40 MHz and $2 \times 10^{33} \text{ cm}^{-2} \text{ s}^{-1}$ and at 3.5 mm from the beams, 2.8 Tb/s data rates, $8 \times 10^{15} \text{ 1 MeV n}_{\text{eq}} \text{ cm}^{-2}$ max fluence

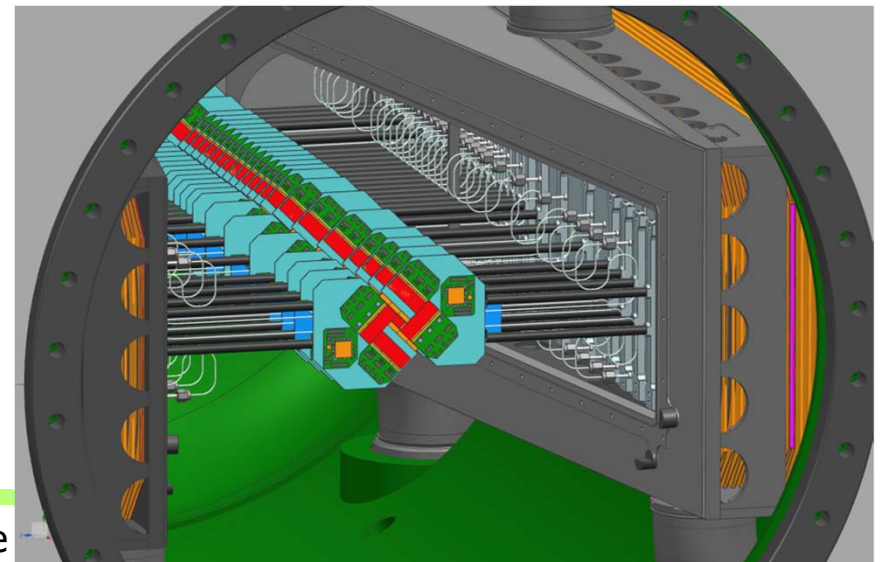
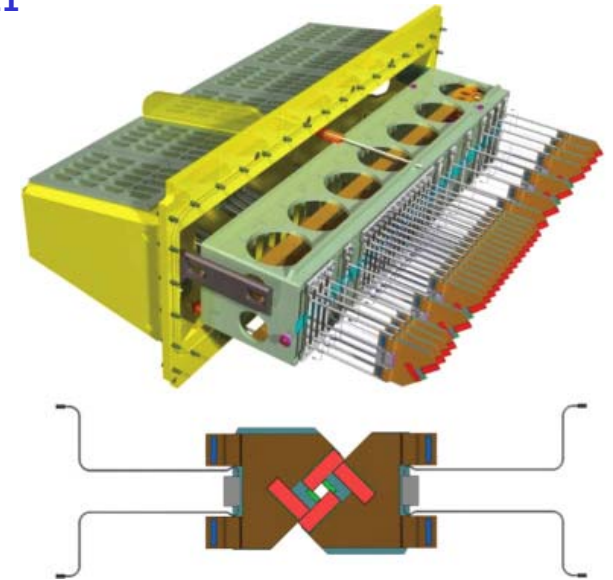
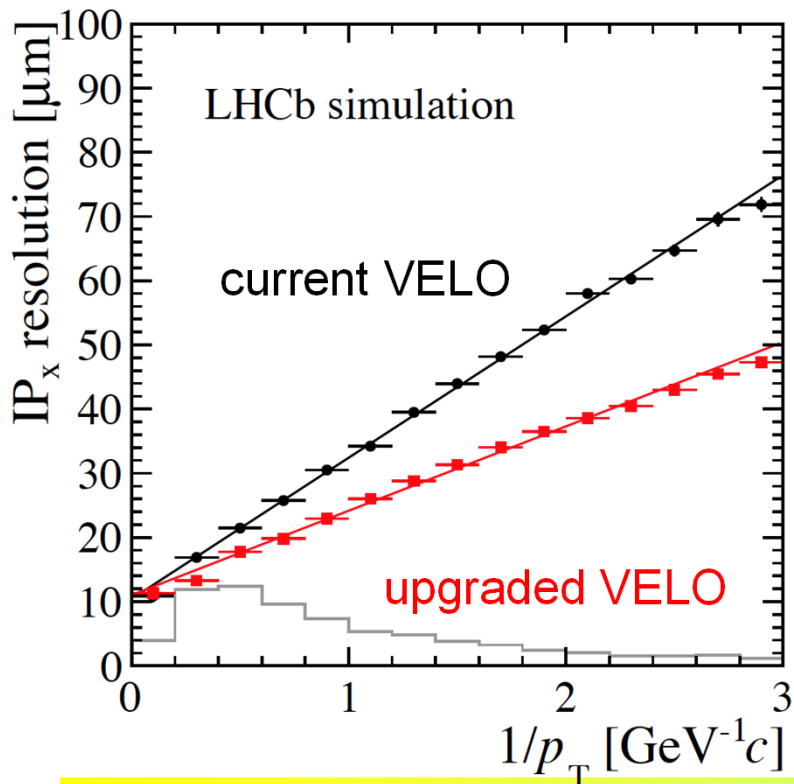

LHCb Vertex LOcator upgrade

Micro-channel cooling

- 500 μm thick silicon substrate with integrated micro channels (70 μm x 200 μm) :
 - same thermal expansion as sensors
 - low material
 - high thermal efficiency
 - cooling power ~ 50 W
- pressure: 14 bar @ -30 $^{\circ}\text{C}$, 60 bar @ 22 $^{\circ}\text{C}$

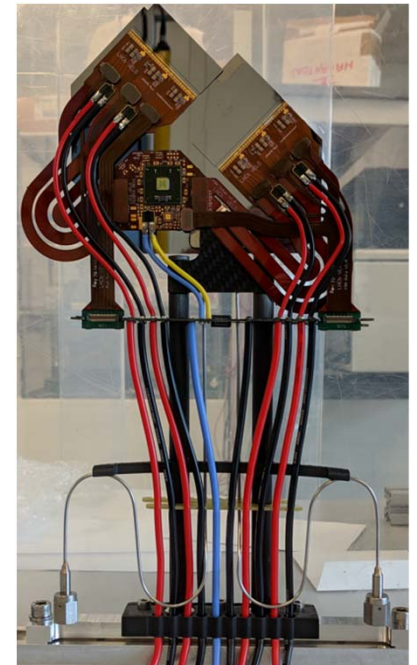
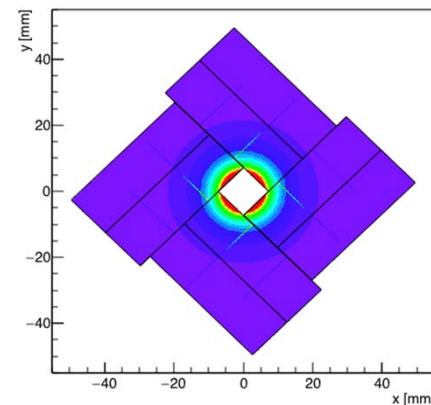
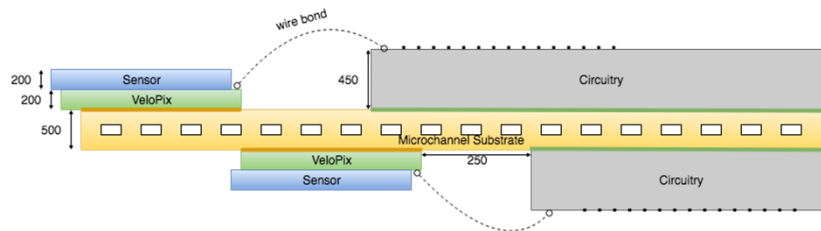
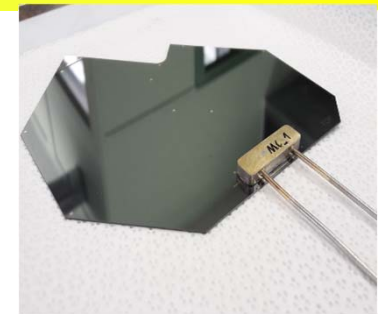
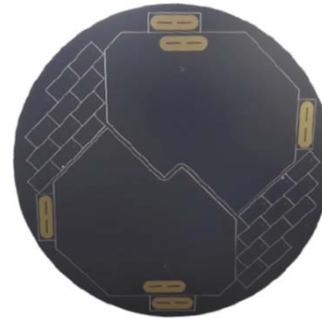

The HL-LHC environment

Radiation levels up to:

- Fluence of 2×10^{16} 1 MeV $n_{\text{eq}}/\text{cm}^2$
- Total Ionizing Dose (TID) ~ 1 Grad
- Pileup up to 240

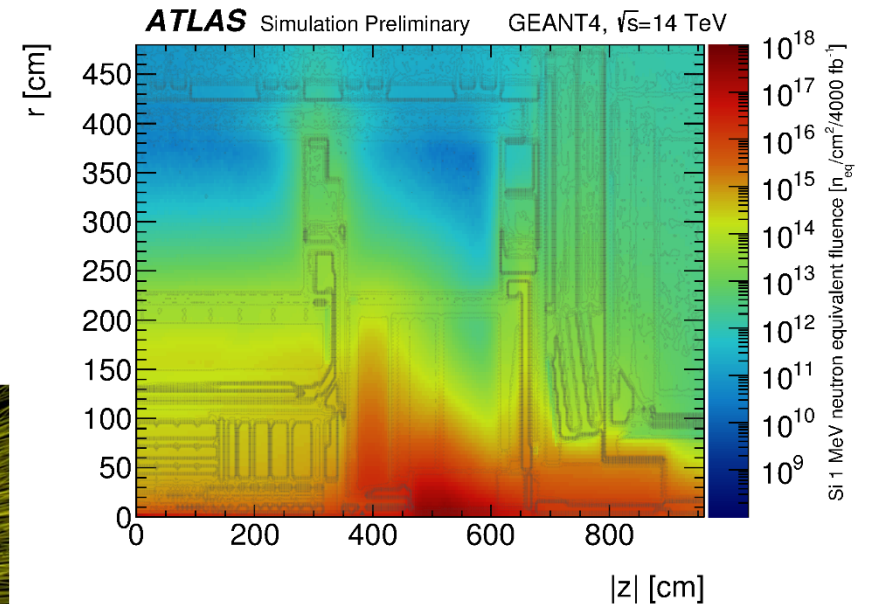
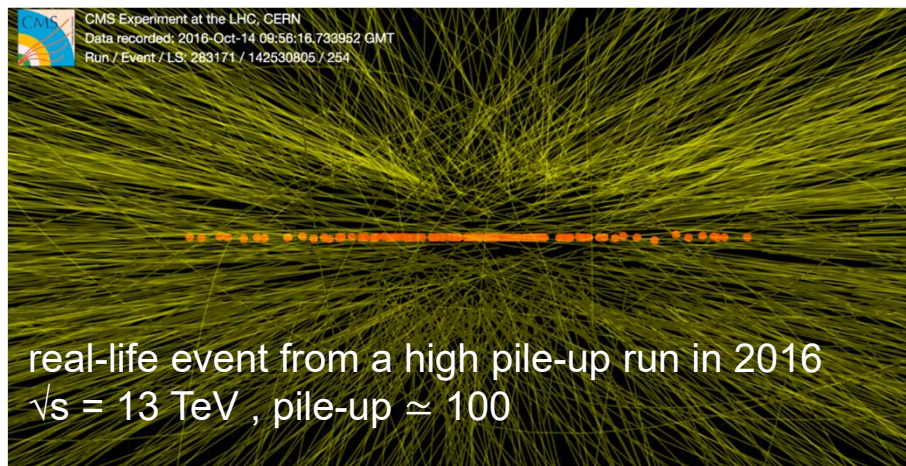

Silicon particle detectors: directions for the future

- Extreme radiation hardness – 3D detectors (hybrid technology – possibly also developments into monolithic)
- Large area coverage for position resolution (mass production) – depleted CMOS sensors (fully monolithic or hybrid ASIC)
- Timing detectors – LGAD with a possible application of 3D (hybrid technology)

3D detectors

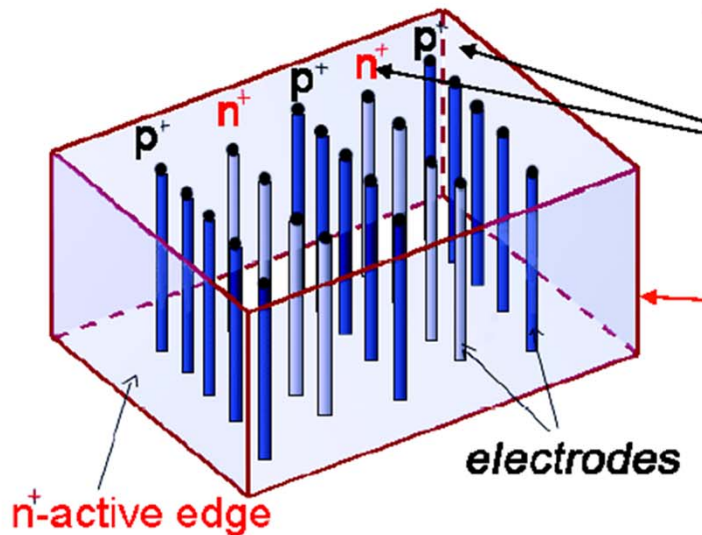

Both electrode types are processed inside the detector bulk instead of being implanted on the wafer's surface.

The edge is an electrode. Dead volume at the edge < 5 μm !

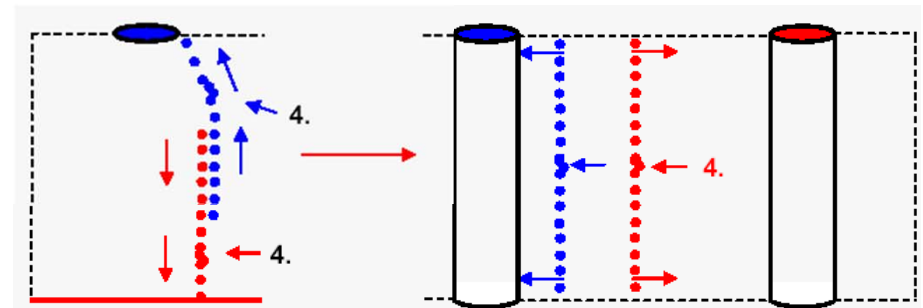

Key advantages

- Better charge collection efficiency over the large fluence range (up to $3 \times 10^{16} \text{ cm}^{-2}$ – close to 100%)
- Faster charge collection (depends on inter-column spacing) – very promising for timing applications
- Reduced full depletion voltage and by that the power
- Larger freedom for choosing electrode configuration
- Recent progress allowing also single sided processing

Limitations

- Columns are a dead area (aspect ratio $\sim 30:1$)
- but most of the tracks are anyway inclined
- Much higher inter-electrode capacitance (hence noise), particularly if small spacing is desired
- Availability on a large scale
- Time-scale and cost

Low Gain Avalanche Detectors (LGAD)

- APD like devices which allow segmentation and high voltage operation close to breakdown
- Pioneered by RD50 and getting more and more attention worldwide (HPK, FBK, Micron)

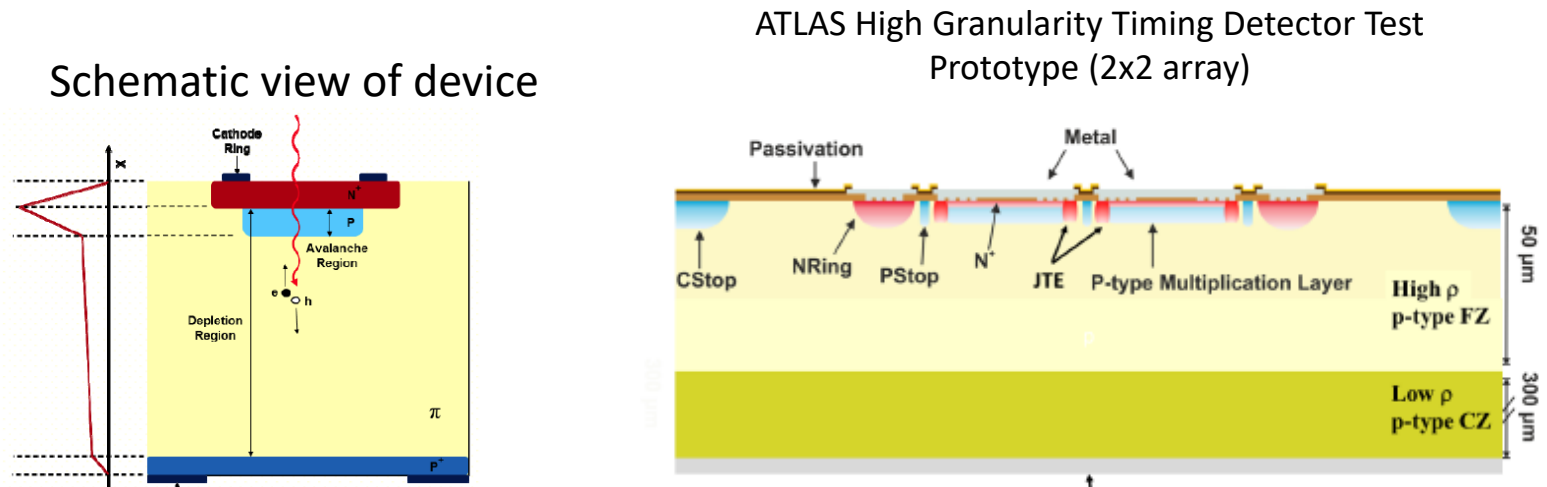

Depleted-CMOS detectors

- HV-CMOS process which allows monolithic detectors with application of external HV depletion
- First devices produced showing huge potential in all respects: scalability (12" wafers), cost and integration (everything integrated on chip electronics + detector)

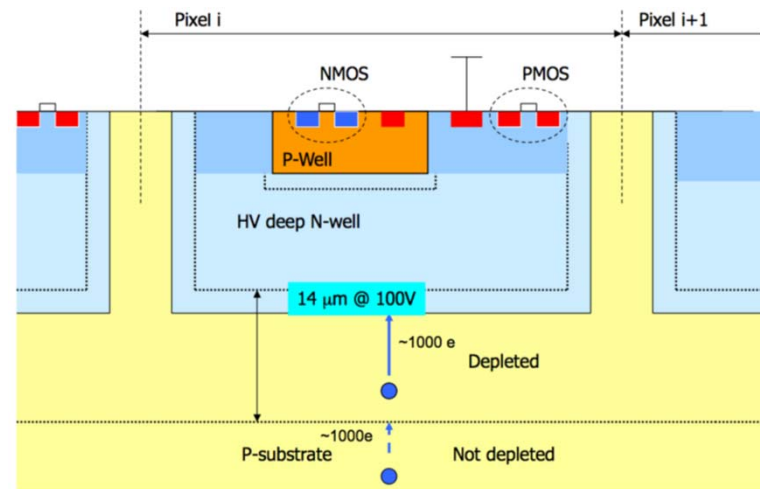

Key properties

- Different substrates often limited by vendor – up to full depletion of 300 μm
- Excellent position resolution

Limitations:

- Radiation hardness – problem of acceptor removal which changes detector performance
- Speed – for timing applications is not yet optimal
- SOI substrates or different other designs/processes including “Shallow Trench Isolation” affect charge collection

Particle identification

Essential: reduces the combinatorial background and allows to tag the flavour of decaying particles.

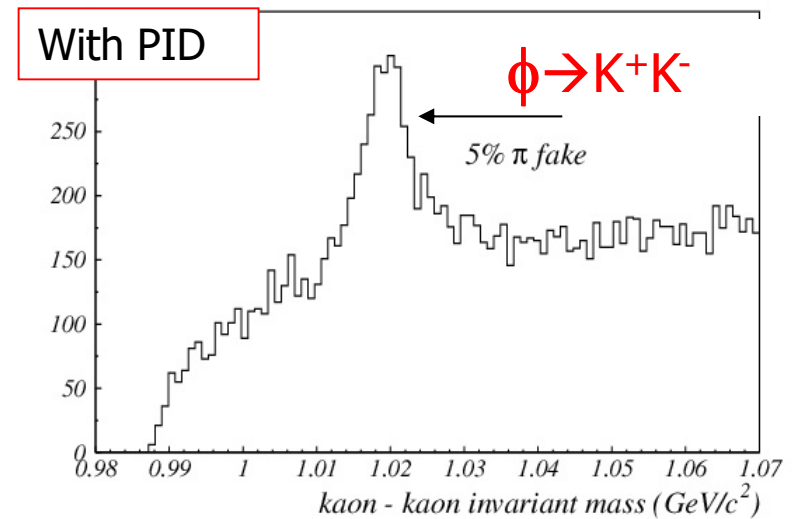
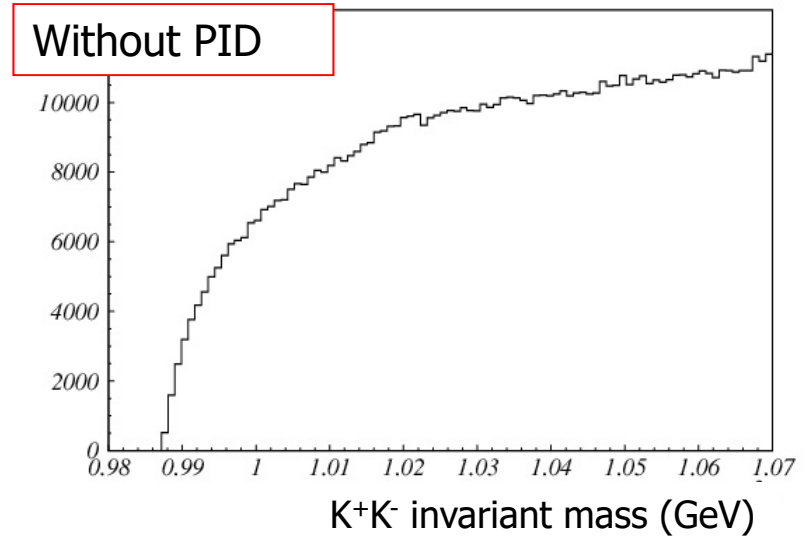
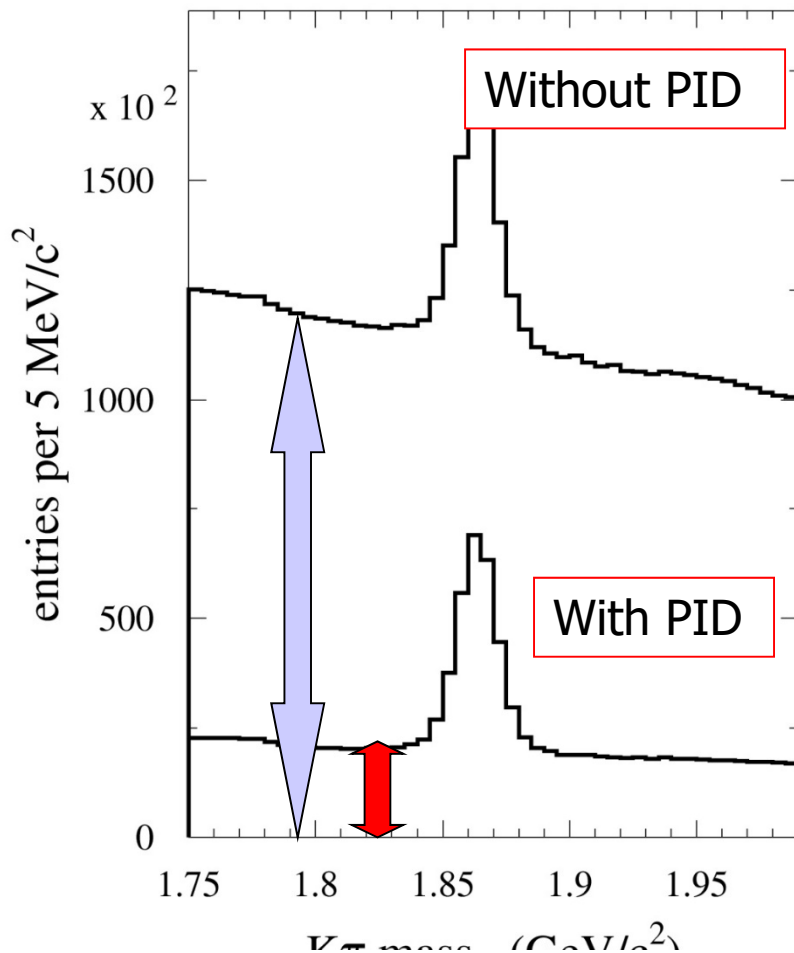

The LHCb RICH counters

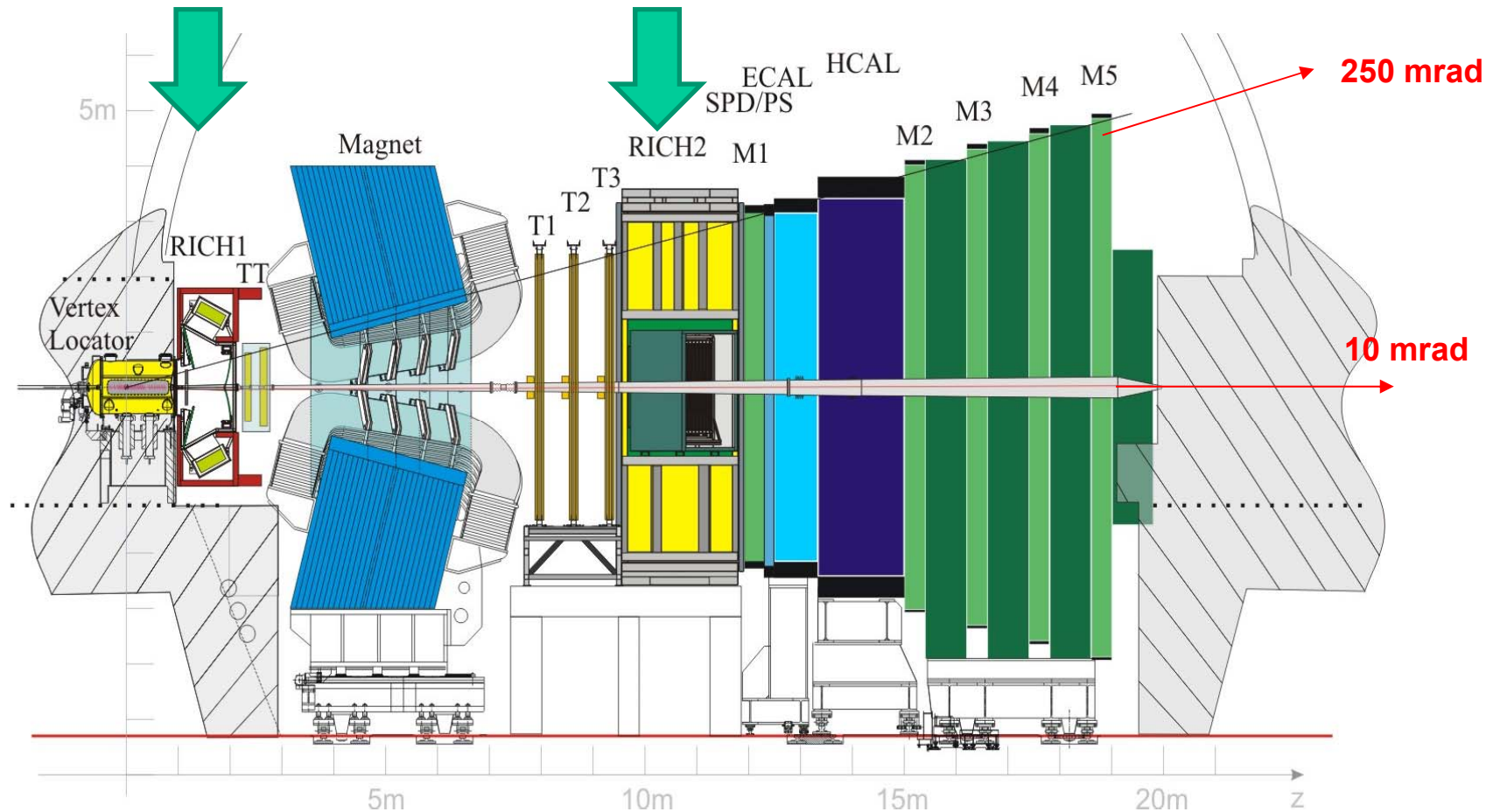

Vertex reconstruction:
VELO

Trigger:
Muon Chambers
Calorimeters
Tracker

PID:
RICHes
Calorimeters
Muon Chambers

Kinematics:
Magnet
Tracker
Calorimeters

LHCb RICHes

Need:

- Particle identification for momentum range $\sim 2\text{-}100\text{ GeV}$
- Photosensor granularity $2.5 \times 2.5\text{ mm}^2$
- Large area (2.8 m^2) with high active area fraction
- Fast compared to the 25 ns bunch crossing time
- Have to operate in a small B field

→ 3 radiators (originally)

- Aerogel
- C_4F_{10} gas
- CF_4 gas

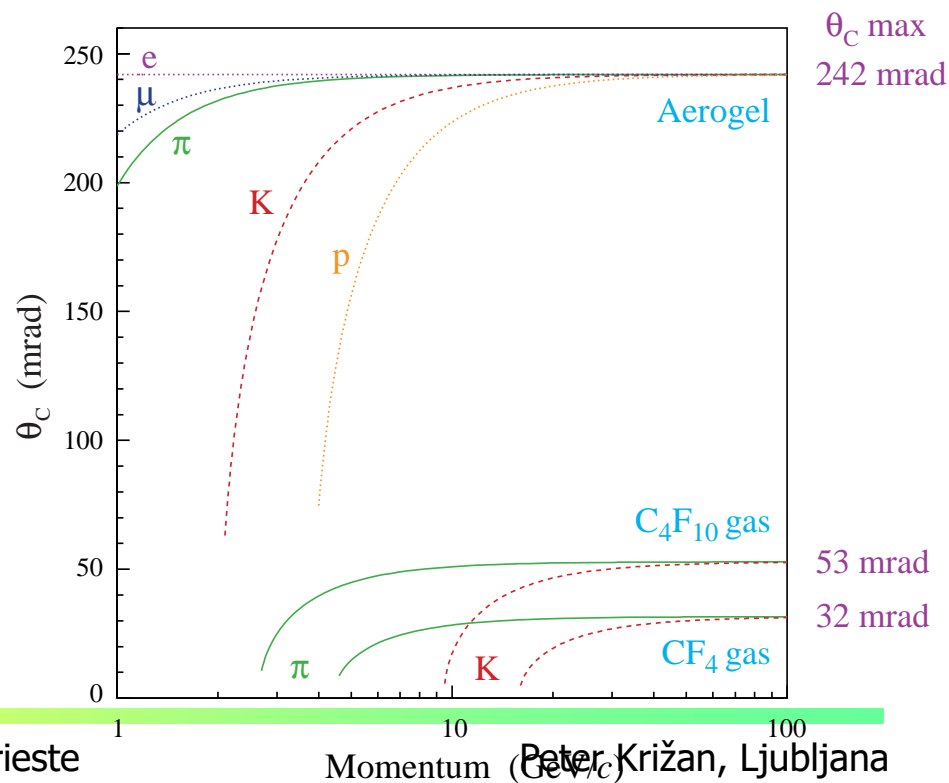
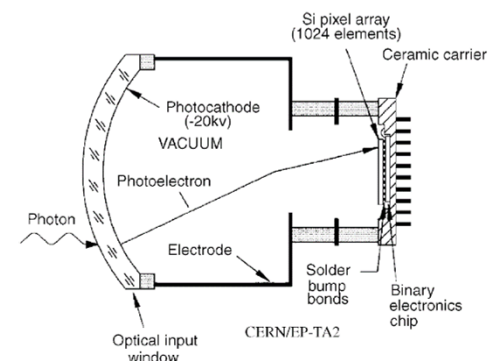

LHCb RICHes

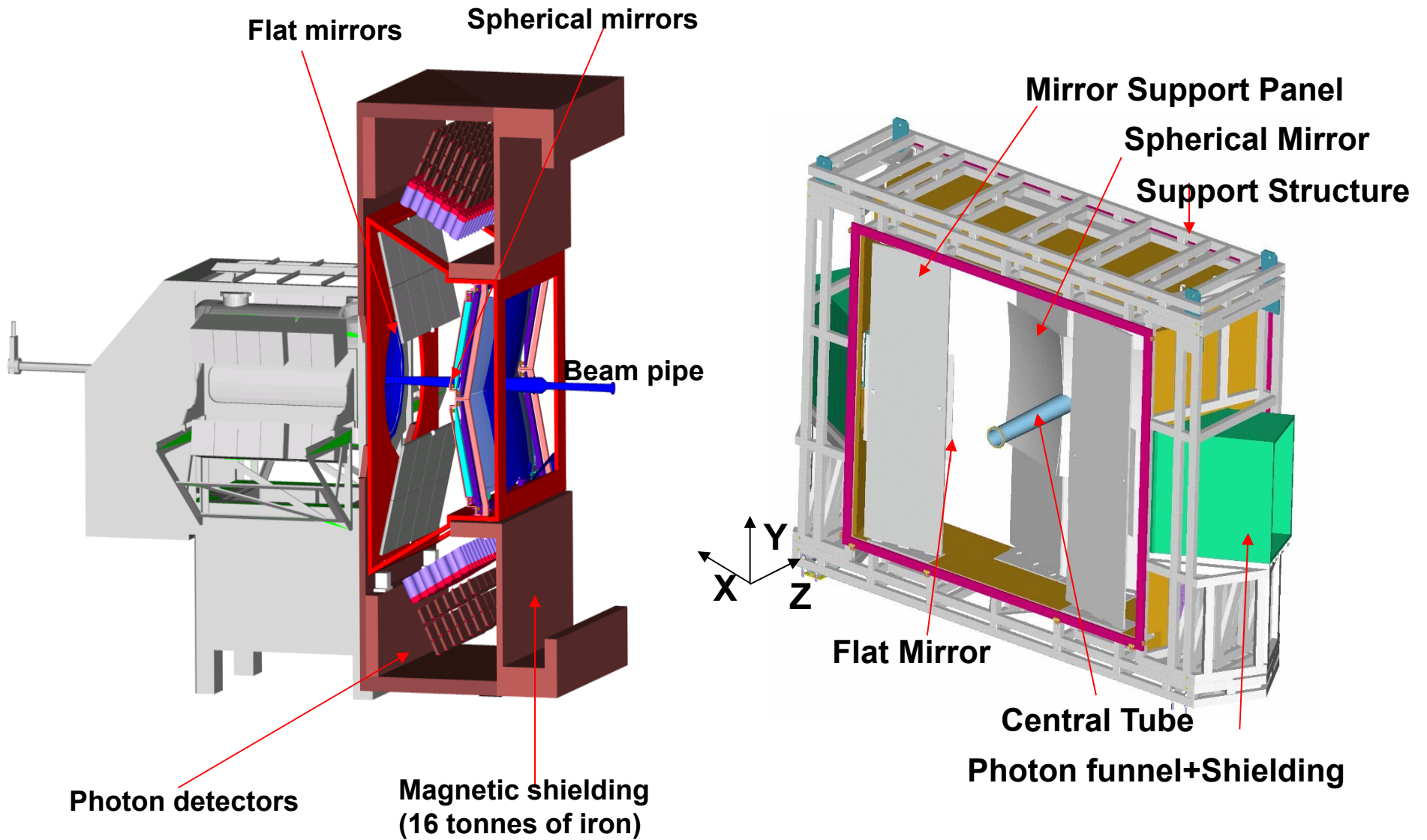

LHCb RICHes: performance

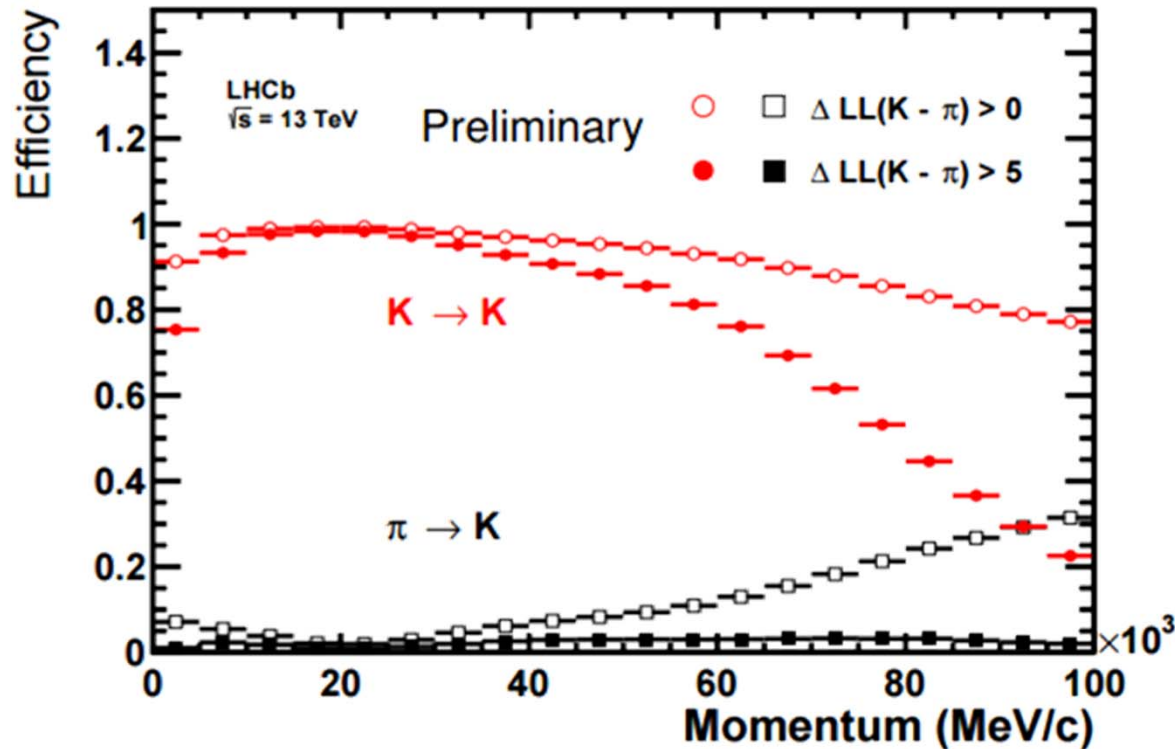

Efficiency and purity from data \rightarrow excellent agreement with MC

Performance of the two RICHes essential for the big success of the LHCb experiment

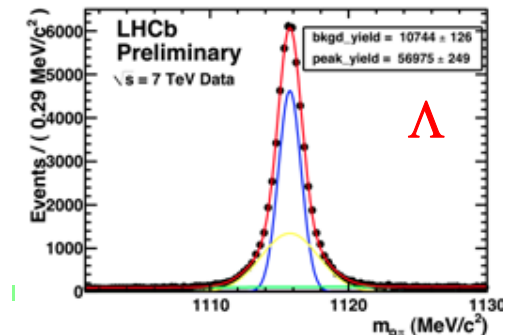
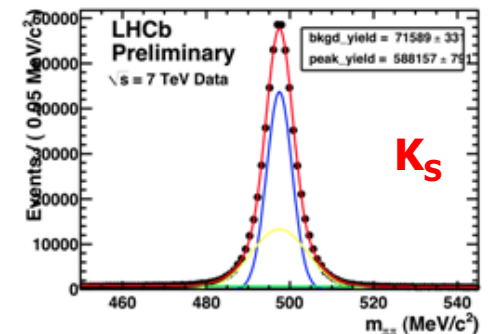
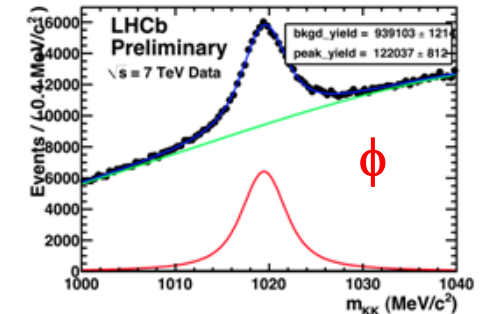
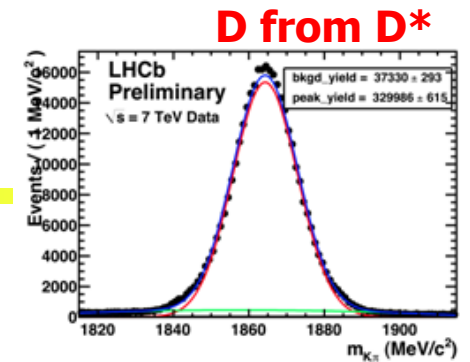

LHCb particle identification upgrade(s)

RICH Upgrade

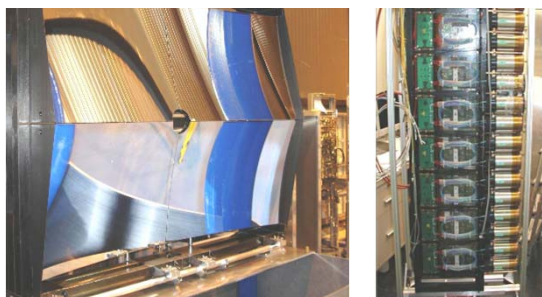

Photosensor: Hybrid Photon Detector with 1 MHz max. readout rate

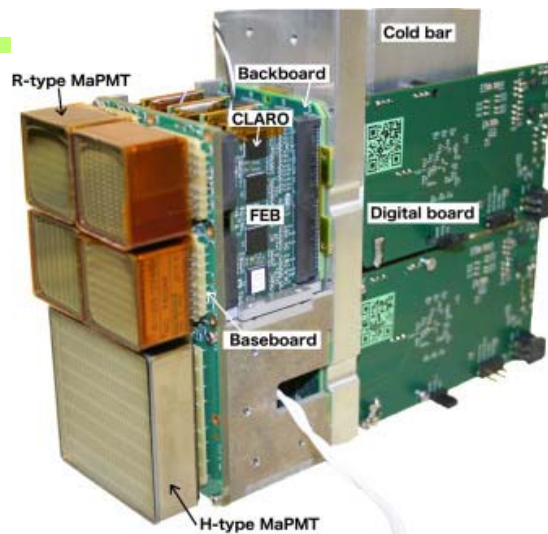
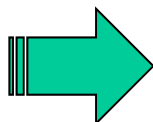

MaPMTs from Hamamatsu

Upgrade IA: New optics, photo detectors, new electronics

LS3

TORCH (Time Of internally Reflected CHerenkov light)
ToF resolution ~10-15 ps (per track) using micro channel plate PMTs

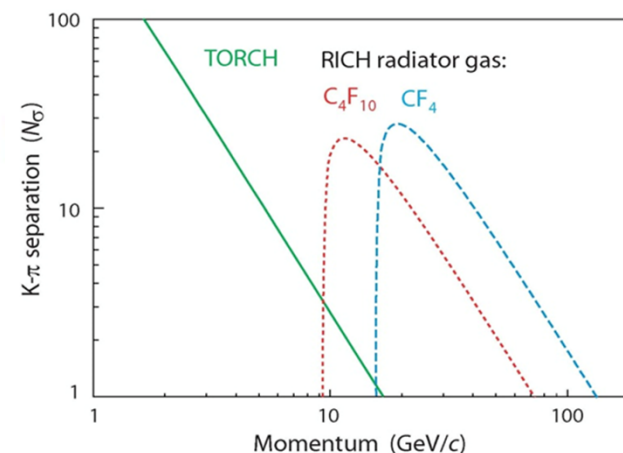
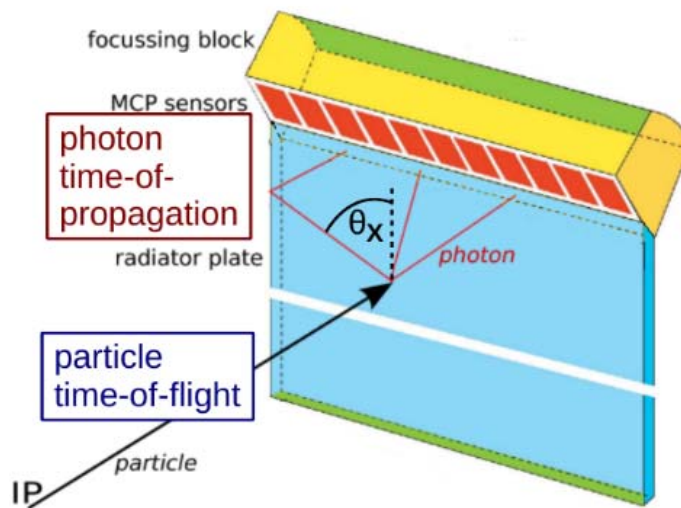

Nov 16-18, 2020

IWHSS2020, Trieste

Peter Križan, Ljubljana



Belle II PID systems

Barrel PID: Time of Propagation Counter (TOP)

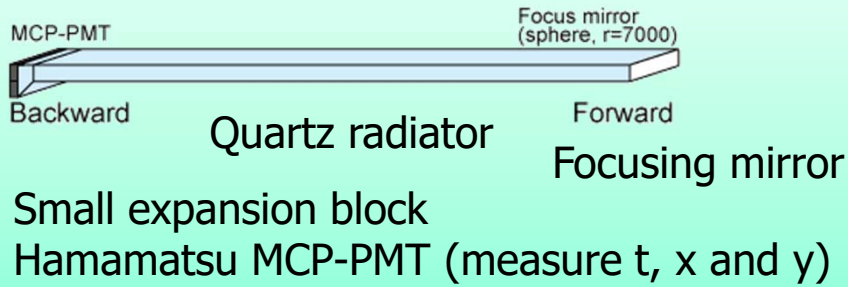

Endcap PID: Aerogel RICH (ARICH)

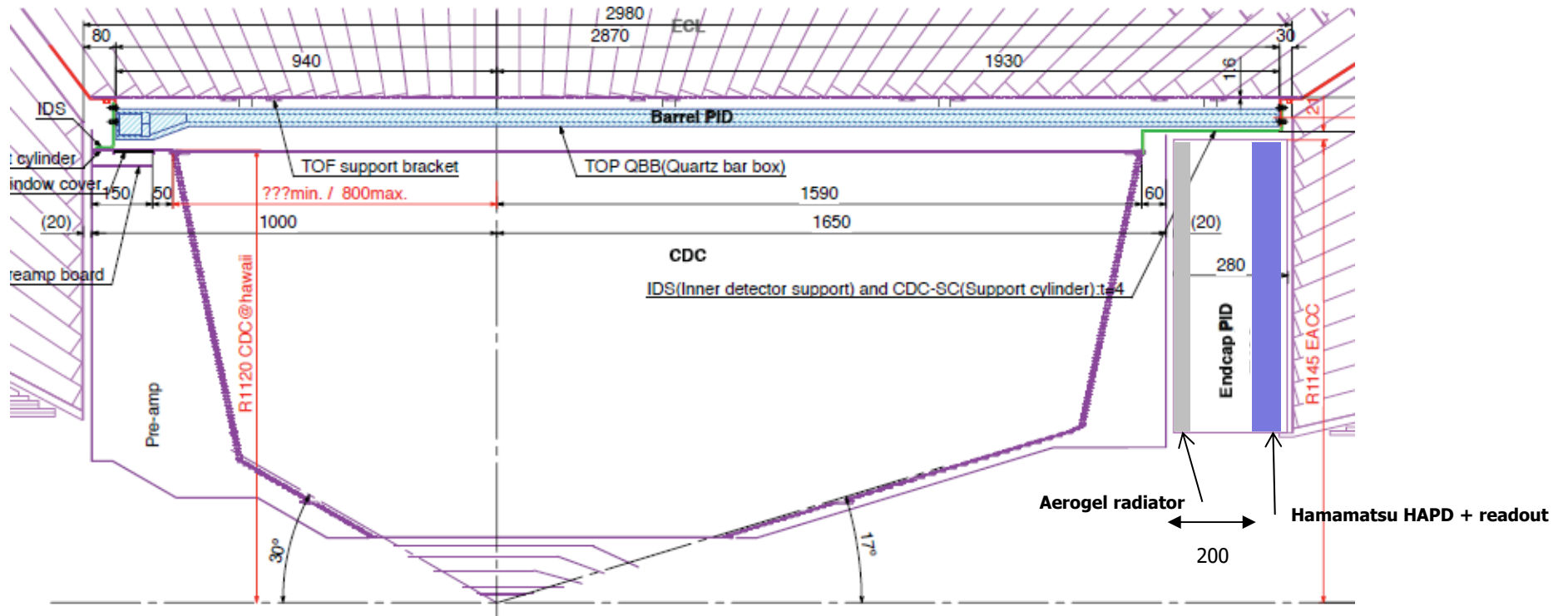
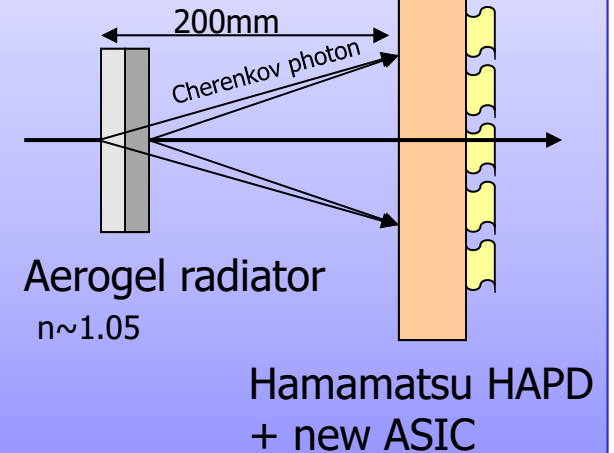



PID Devices: ARICH

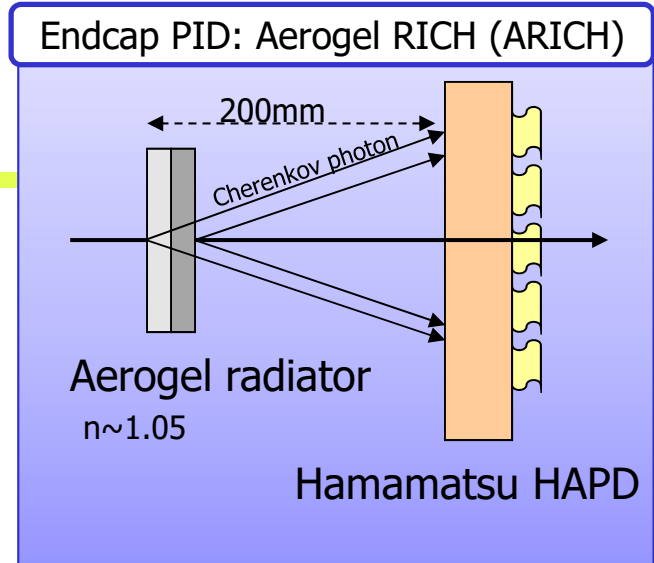
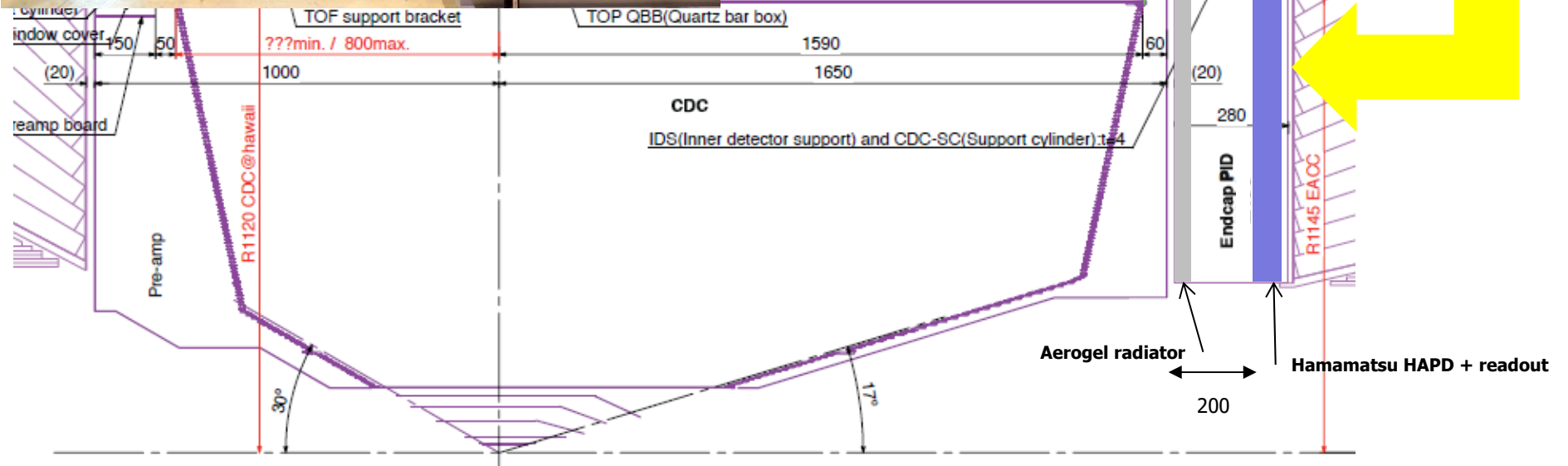
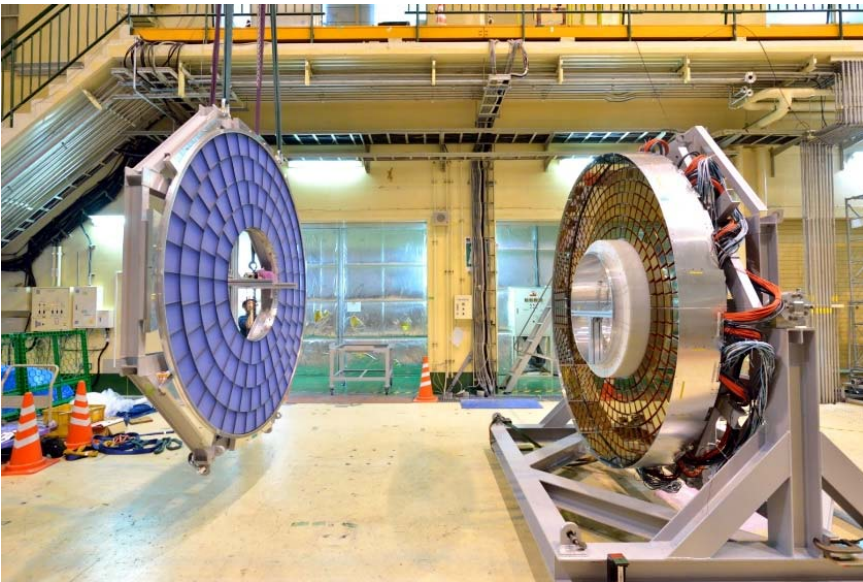

Radiator with multiple refractive indices

Small number of photons from aerogel → need a thick layer of aerogel.

How to improve the resolution by keeping the same number of photons?

→ stack two tiles with different refractive indices: “focusing” configuration → “focusing radiator”

normal

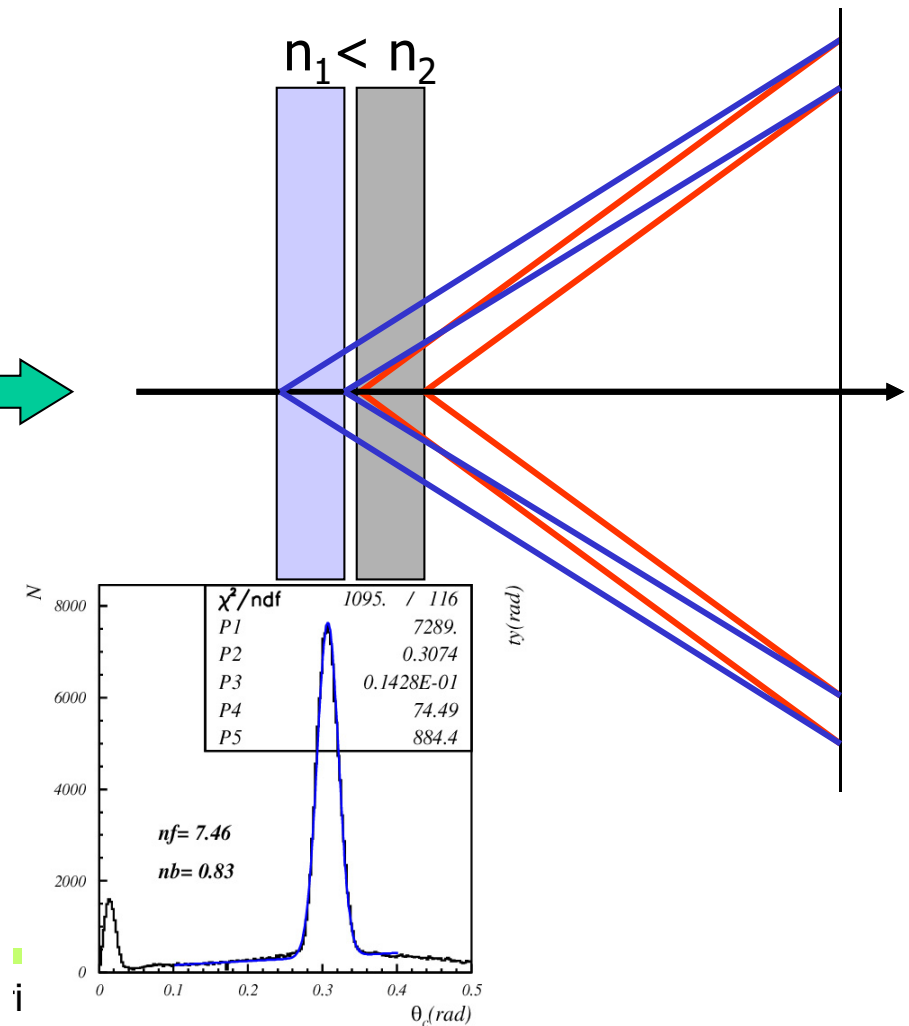
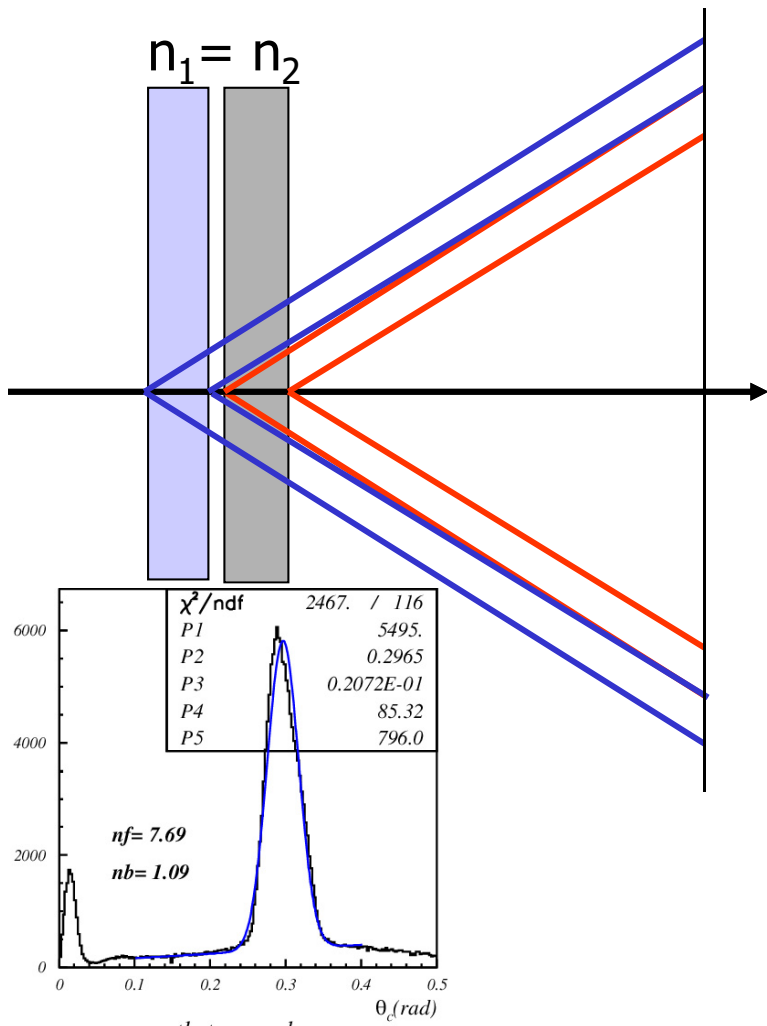



The big eye of ARICH

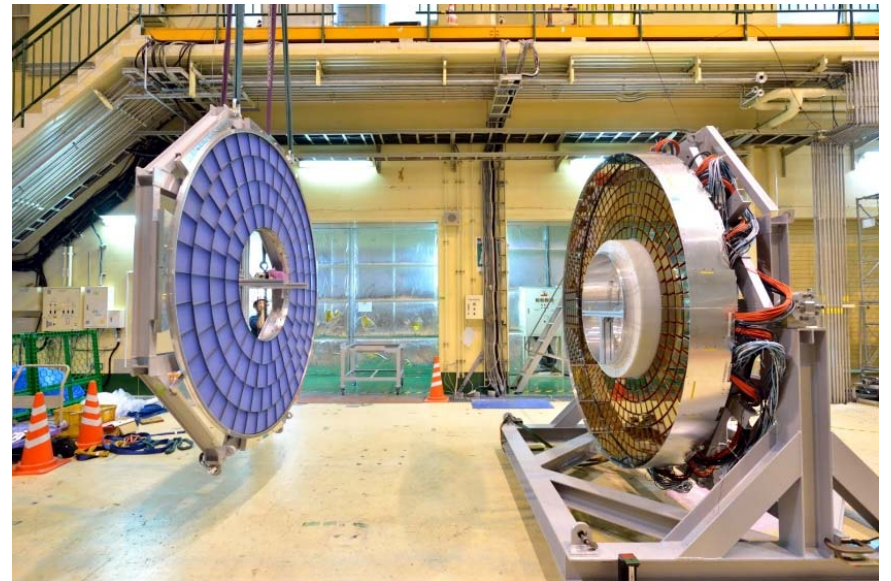
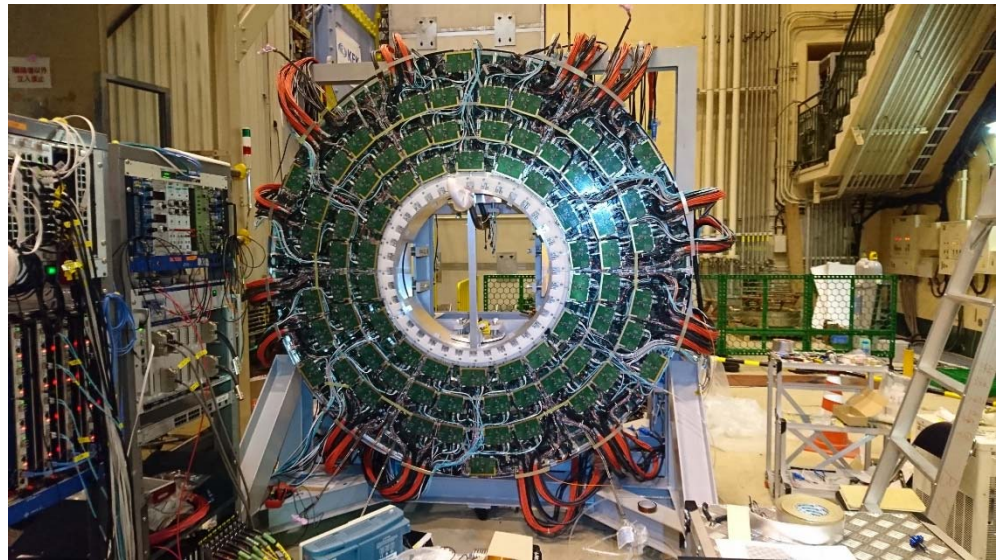
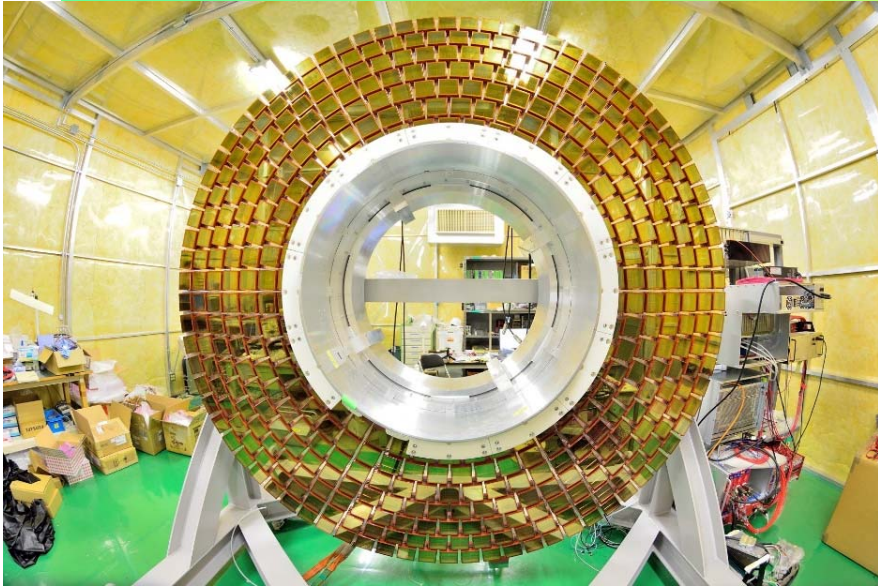
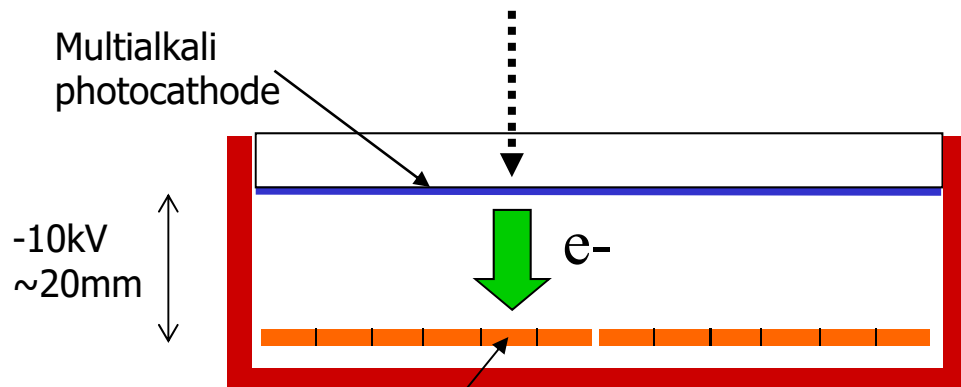

Photo-sensors: 420 HAPDs



Nov 16-18, 2020

IWHSS2020, Trieste

Peter Križan, Ljubljana

Performance in the early Belle II data



Cherenkov angle distribution in $e^+e^- \rightarrow \mu^+\mu^-$

Overall a very good
DATA/MC agreement !

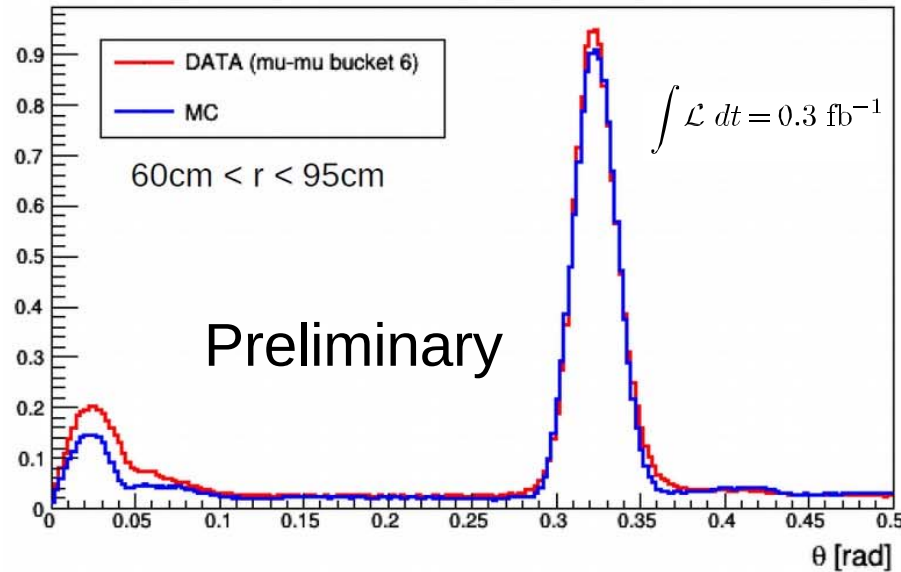

DATA

$$N_{sig} = 11.38/\text{track}$$

$$\sigma_c = 12.7 \text{ mrad}$$

MC

$$N_{sig} = 11.27/\text{track}$$

$$\sigma_c = 12.75 \text{ mrad}$$

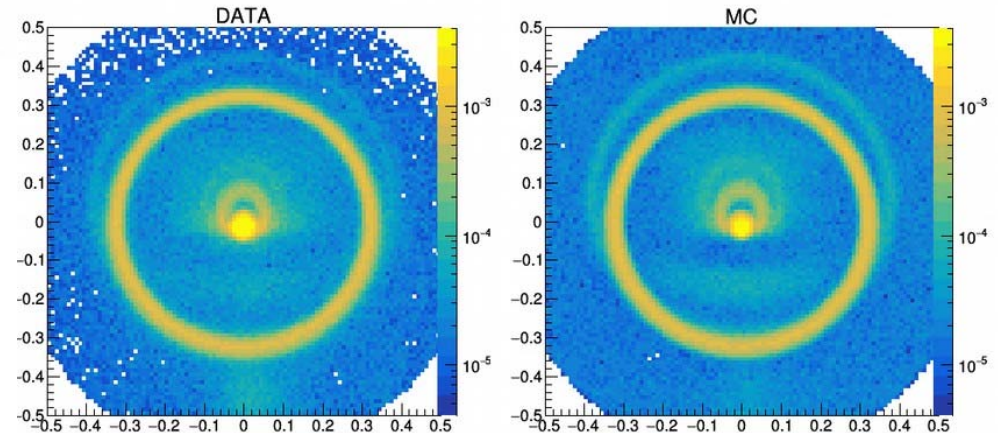
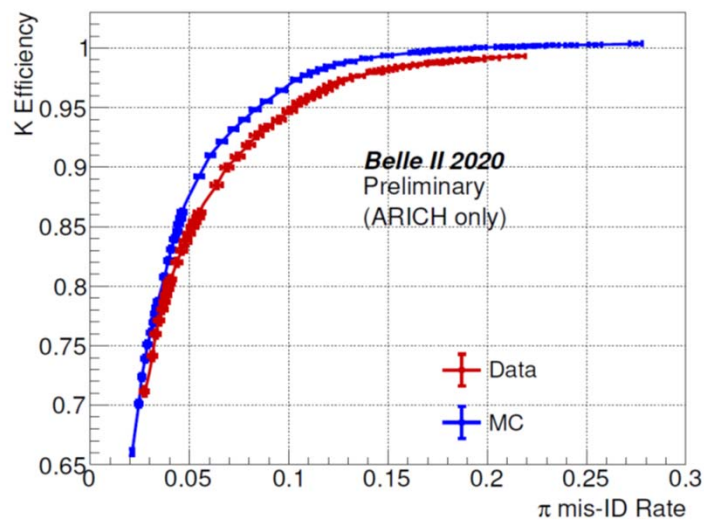

Cherenkov ring (accumulated)

Refinements of PDFs are underway, further
improvements of performance expected

Barrel PID: Time of propagation (TOP) counter



One of the new generation devices inspired by the DIRC counter of the BaBar experiment

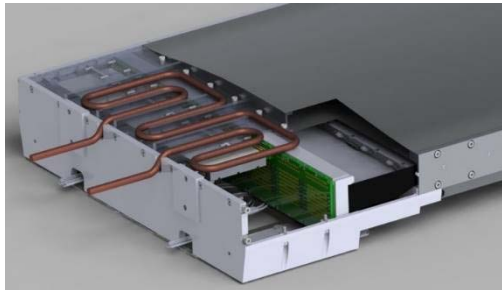

Photon detector

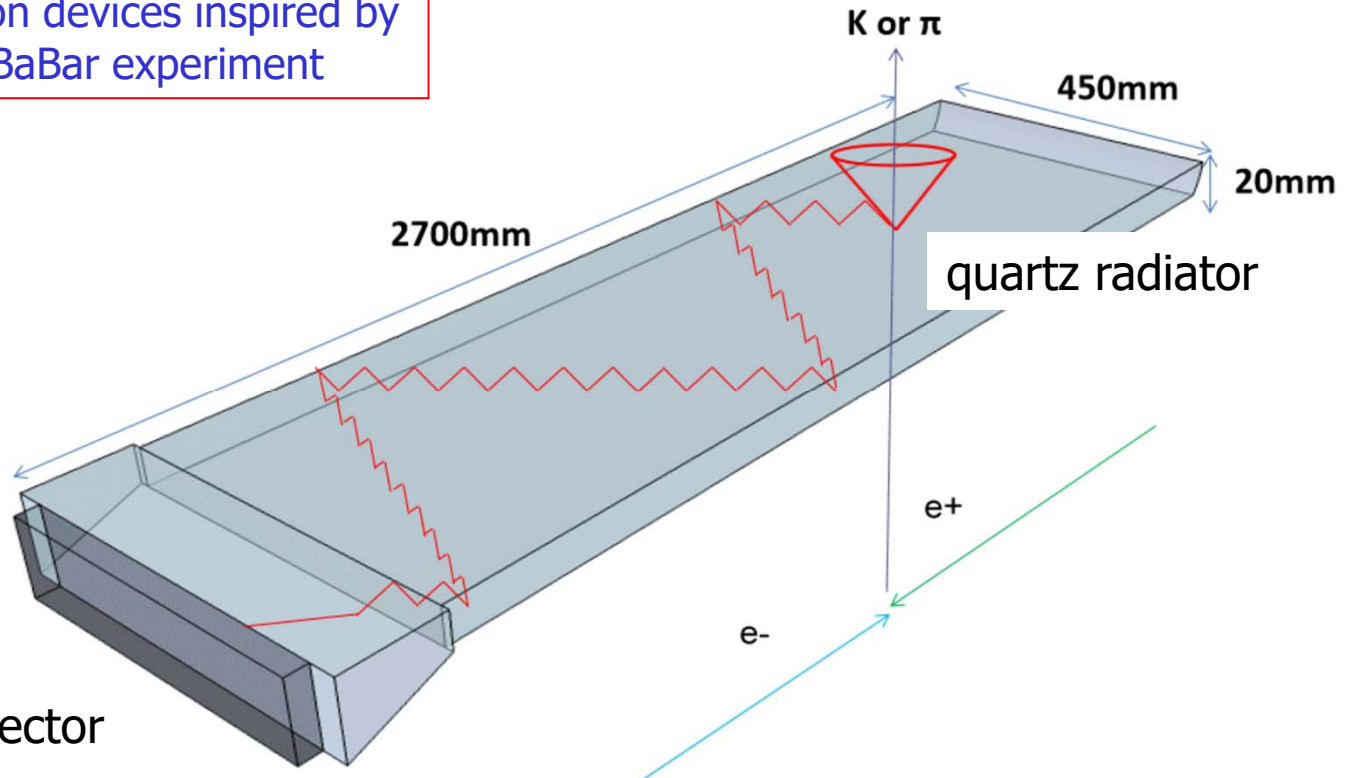

- Cherenkov ring imaging with precise time measurement.
- Reconstruct Cherenkov angle from two hit coordinates and the time of propagation of the photon
 - Quartz radiator (2cm thick)
 - Photon detector (MCP-PMT)
 - Excellent time resolution ~ 40 ps
 - Single photon sensitivity in 1.5 T

TOP image reconstruction

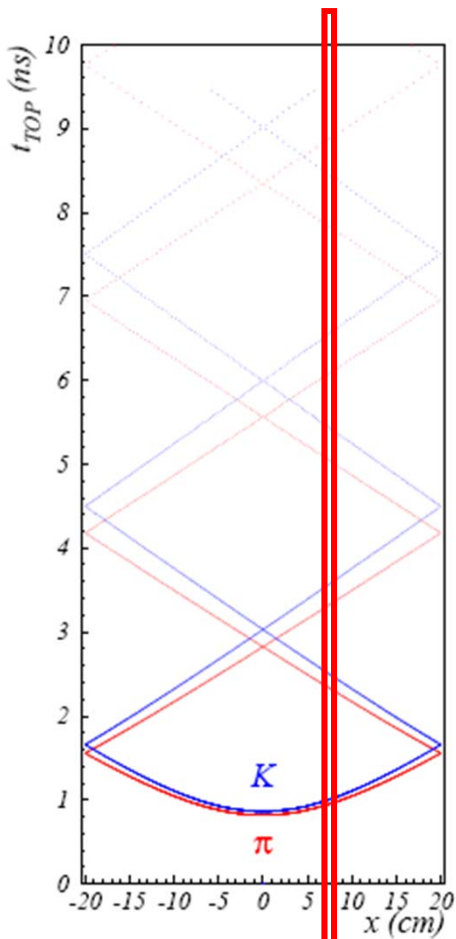

Pattern in the coordinate-time space ('ring') of a pion and kaon hitting a quartz bar

Time distribution of signals recorded by one of the PMT channels (slice in x): different for π and K (~shifted in time)

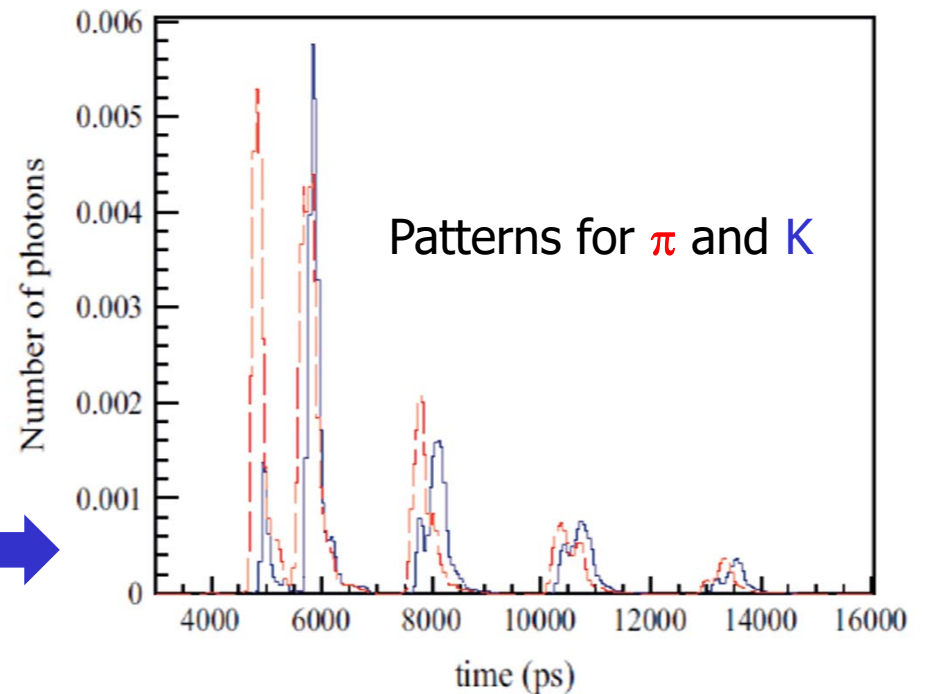

The name of the game: analytic expressions for the 2D likelihood functions

→ NIMA A595 (2008) 252-255

TOP R+D areas

- Very fast photosensors for operation in 1.5 T field (MCP PMTs)
- R+D to mitigate aging of photocathodes in MCP PMTs (ALD)

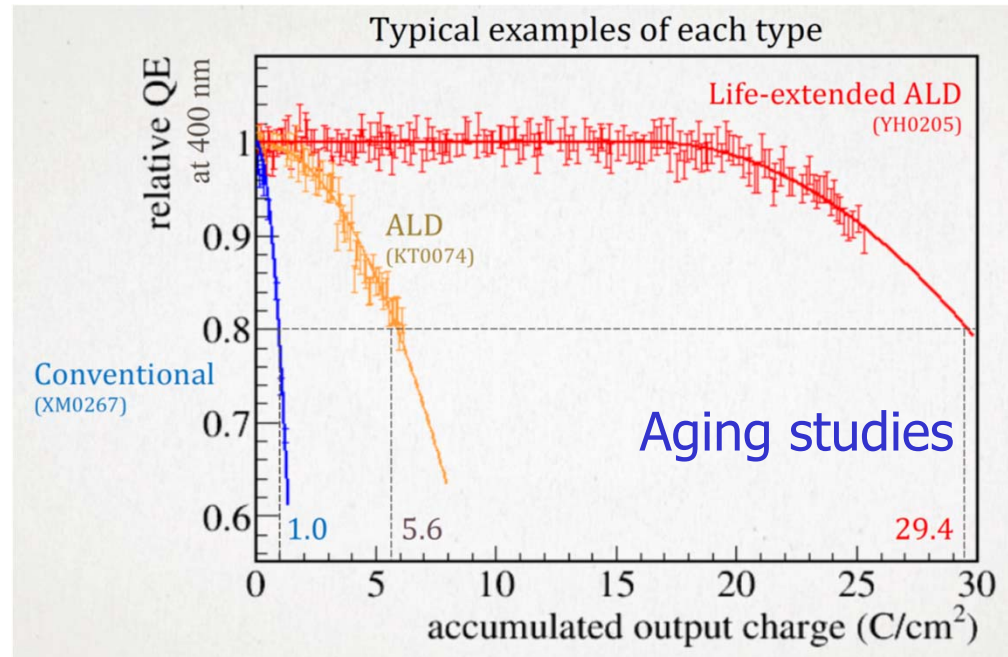
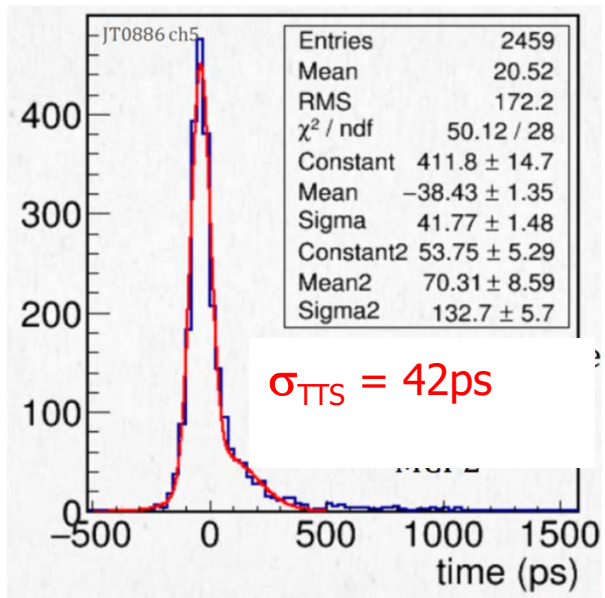

- Very fast and compact readout electronics with waveform sampling for a precise time measurement
- Production of large quartz pieces, construction of modules, mechanics and installation methods
- Analytic expressions for the very complex 2D likelihood functions.

PID for PANDA

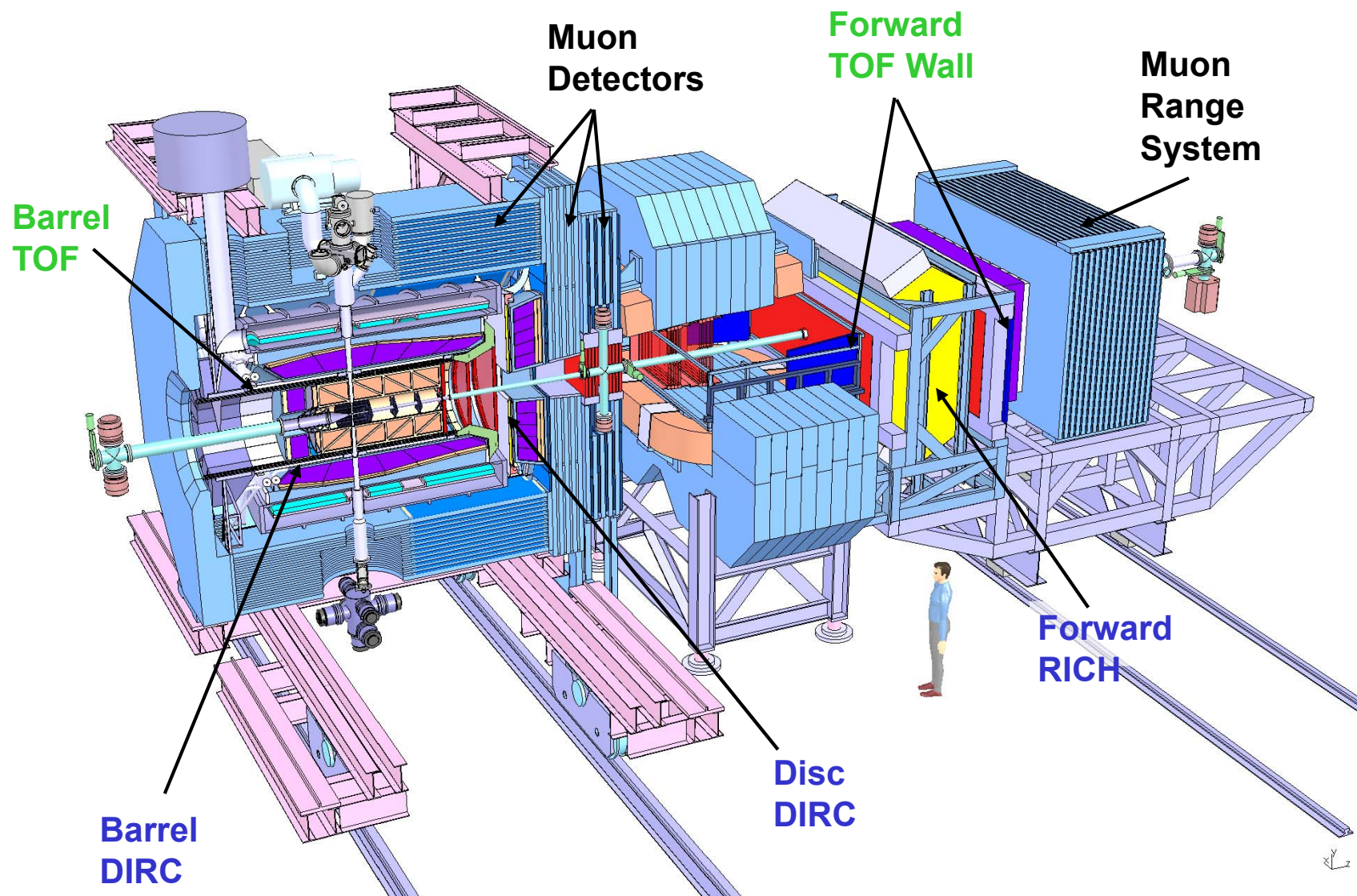

Barrel DIRC

Based on BABAR DIRC and SuperB FDIRC with key improvements

- Barrel radius ~ 48 cm; expansion volume depth: 30 cm.
- 48 narrow radiator bars, synthetic fused silica 17mm (T) x 53mm (W) x 2400mm (L)
- Compact photon detector:
 - 30 cm fused silica expansion volume
 - 8192 channels of **MCP-PMTs** in ~ 1 T B field
- **Focusing optics**: spherical lens system
- Fast photon detection:
 - fast electronics \rightarrow **100-200 ps** timing

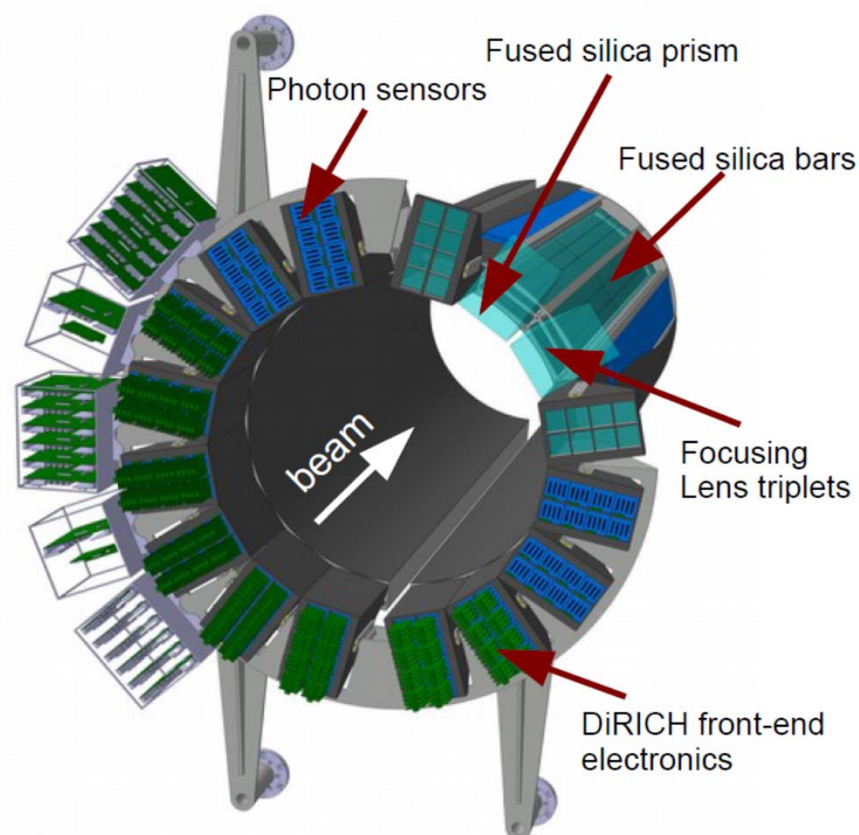

- A similar detector is also considered for the **barrel region of the EIC detector**

PANDA Barrel DIRC

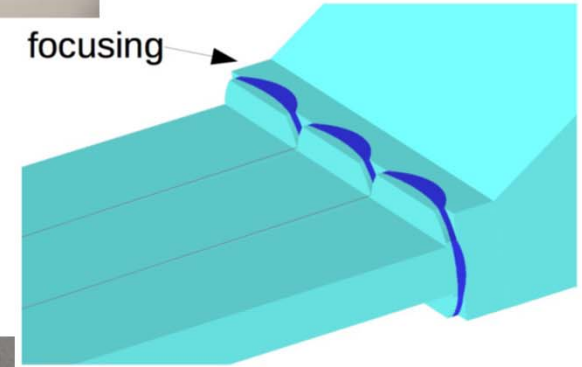
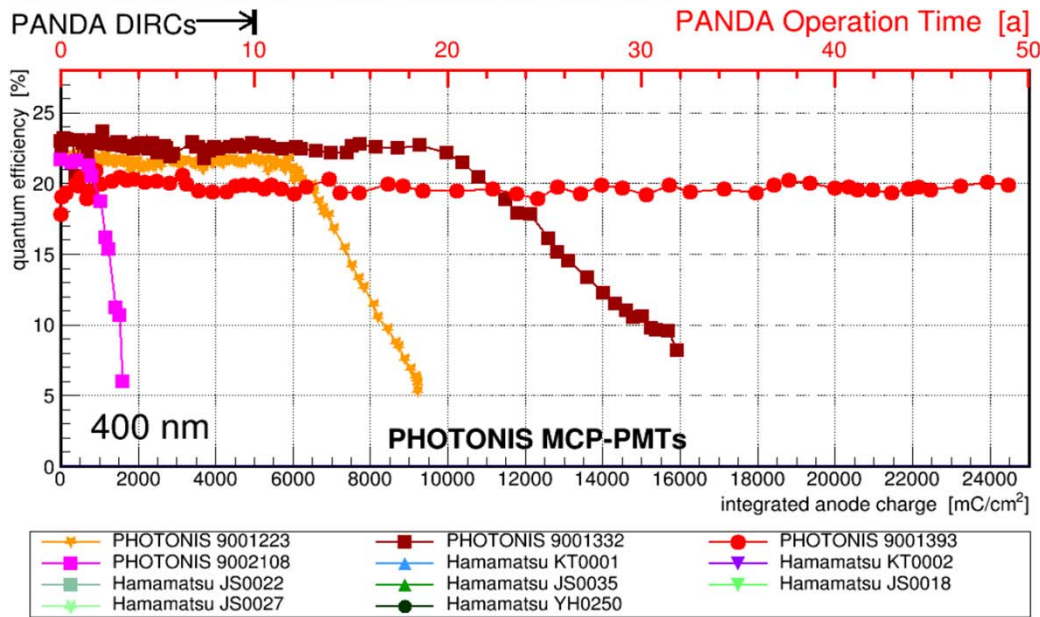
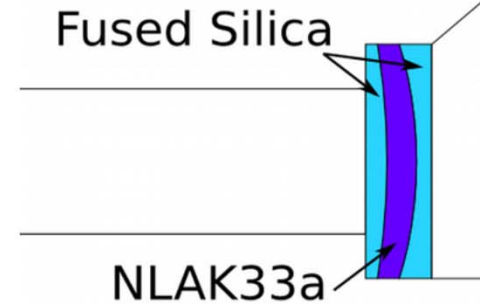
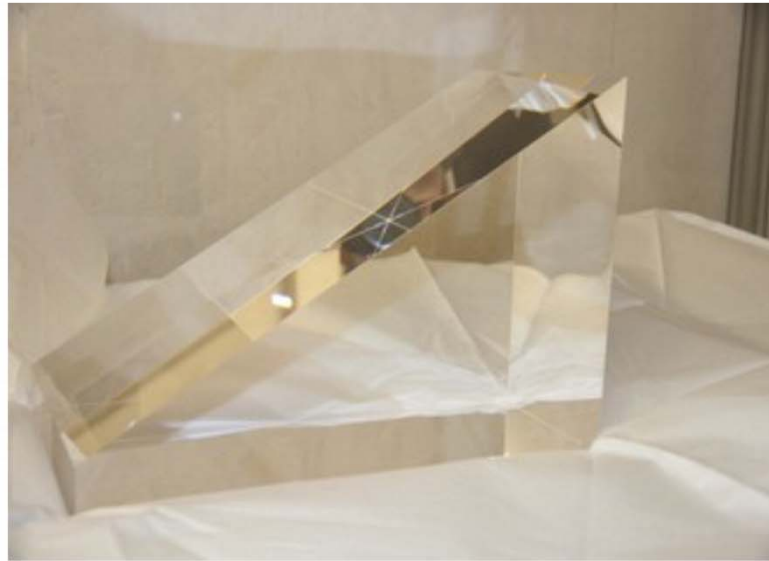
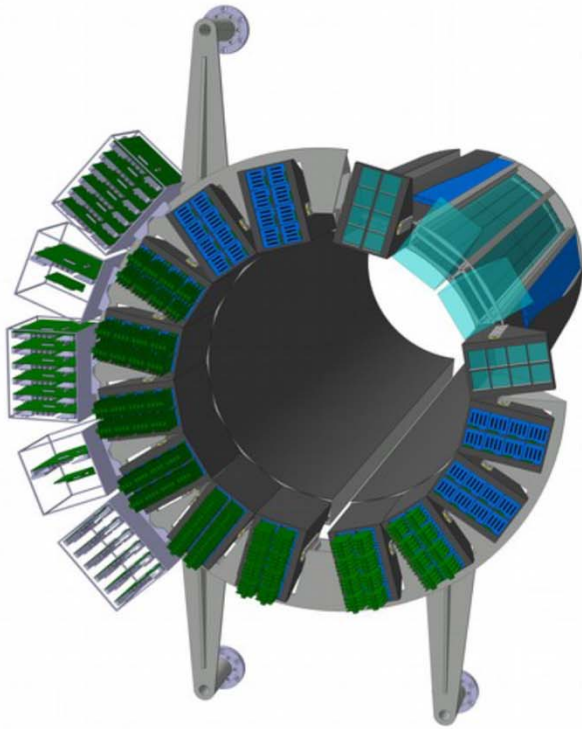

▪ A similar detector is also considered for the barrel region of the EIC detector

PID devices for the Electron Ion Collider

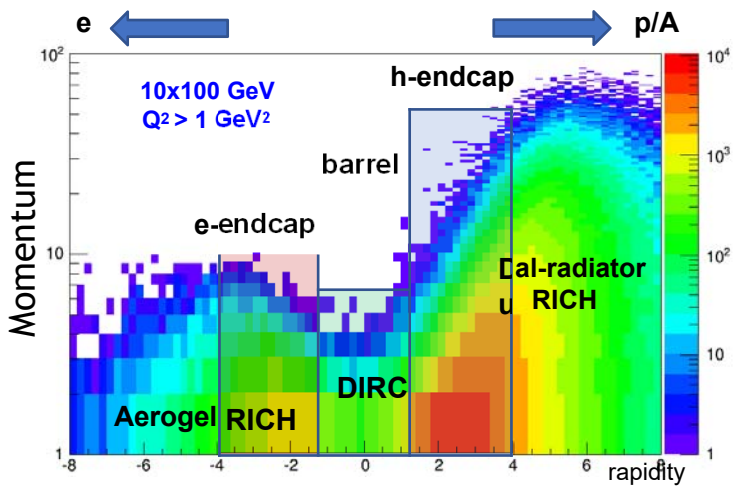

- **h-endcap**: A RICH with two radiators (gas + aerogel) is needed for π/K separation up to ~ 50 GeV/c **dRICH**
- **e-endcap**: A compact aerogel RICH which can be projective π/K separation up to ~ 10 GeV/c **mRICH**
- **barrel**: A high-performance DIRC provides a compact and cost-effective way to cover the area. π/K separation up to $\sim 6-7$ GeV/c **DIRC**

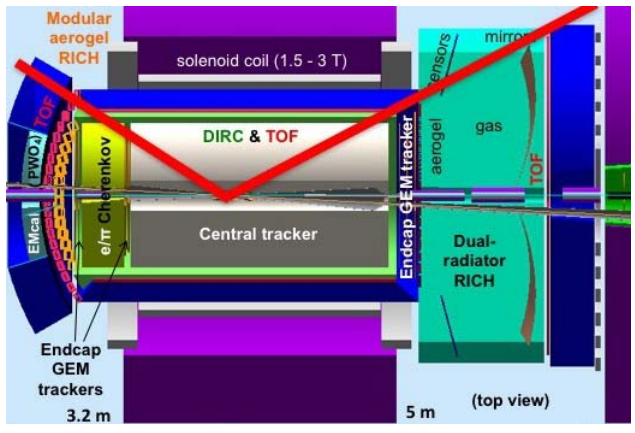

- **TOF (and/or dE/dx in TPC)**: can cover lower momenta.

EIC detector PID: mRICH

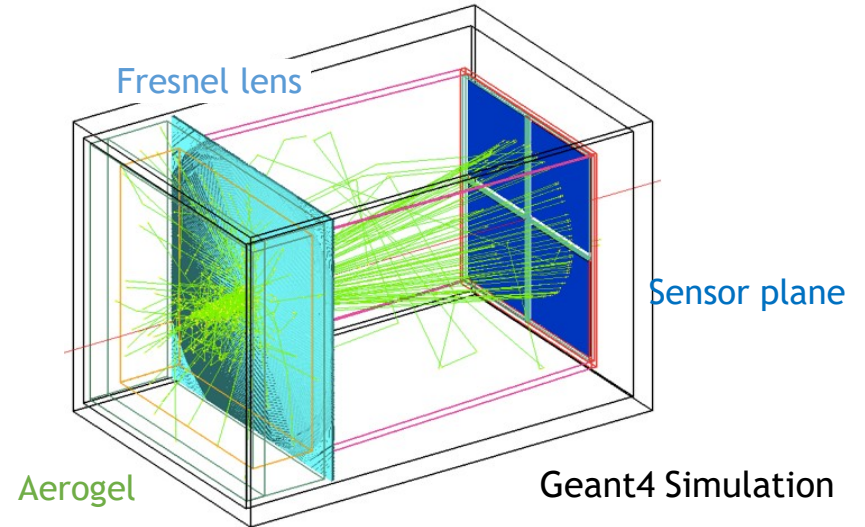
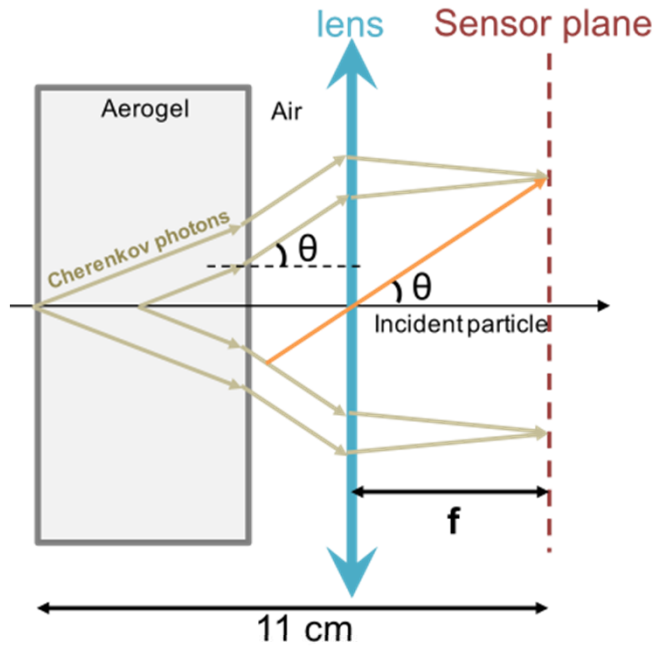

Beam test with SiPMs as sensors

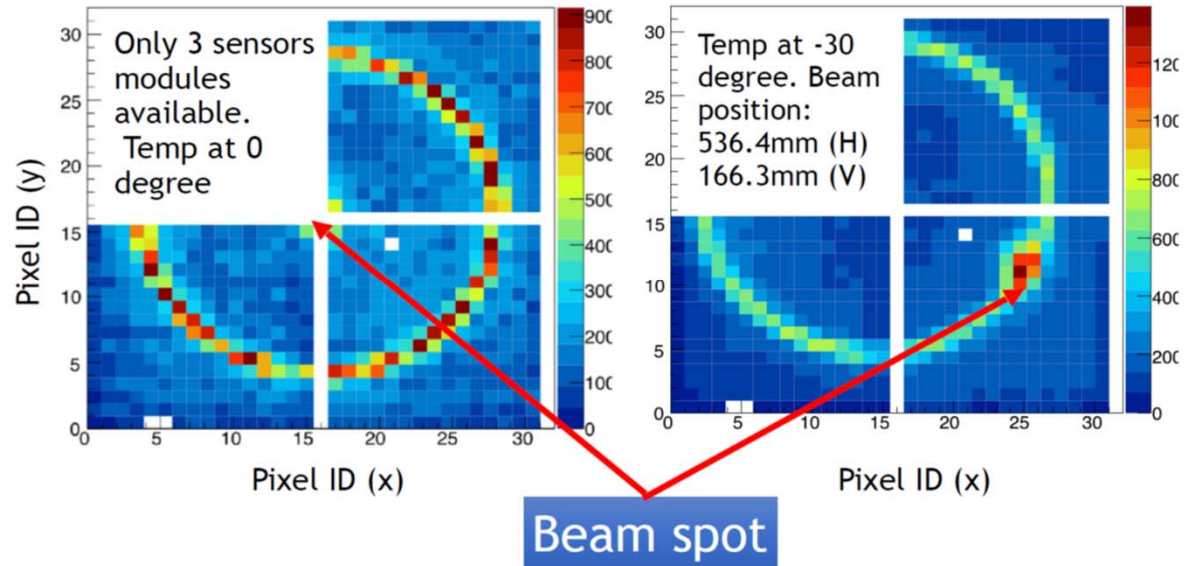
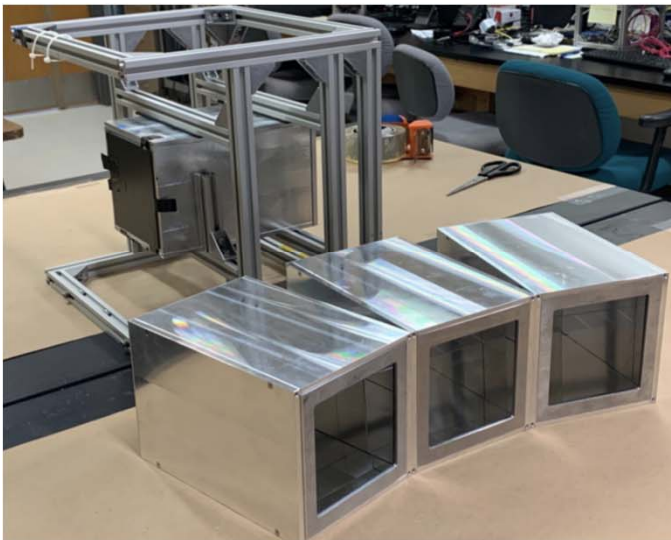

EIC detector PID: dRICH

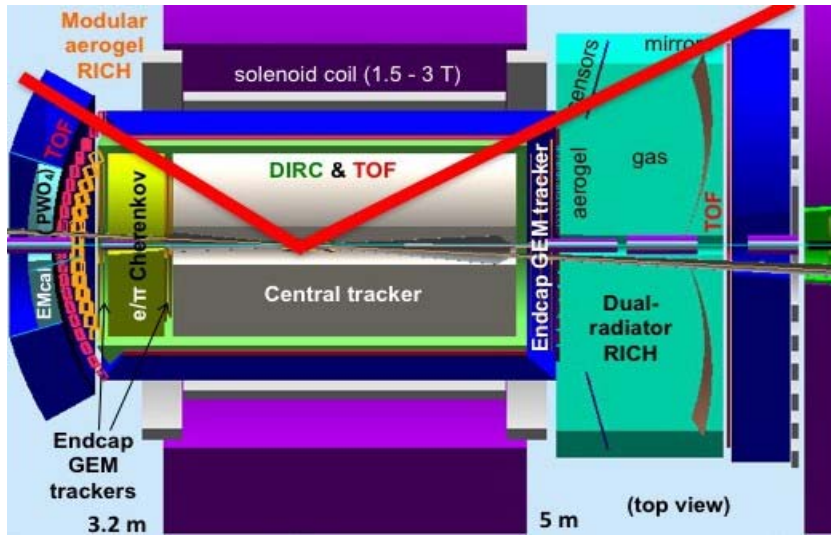

Dual radiator RICH: aerogel and gas

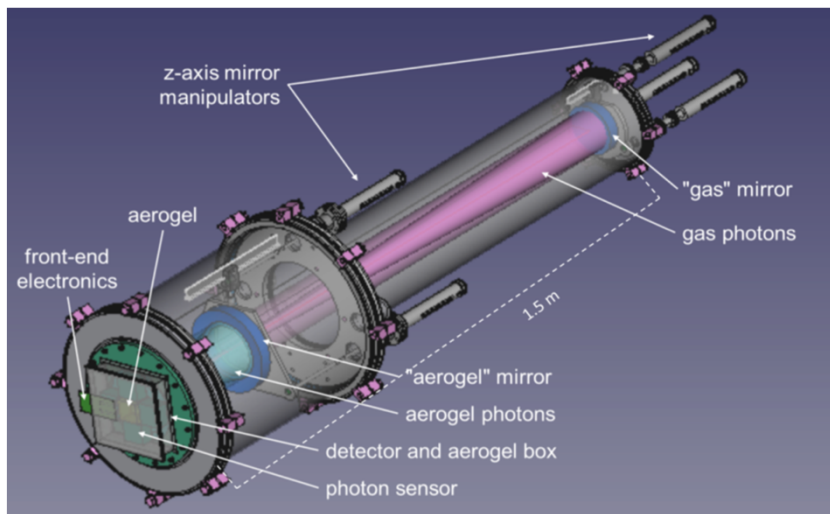

Beam test, apparatus and results

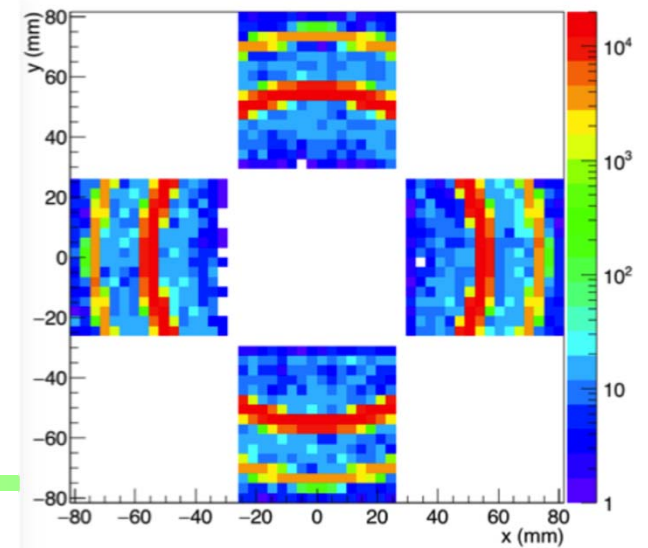

Gas based photo-sensor: THGEM + micromegas

Developed for COMPASS
with CsI as the
photosensitive substance.

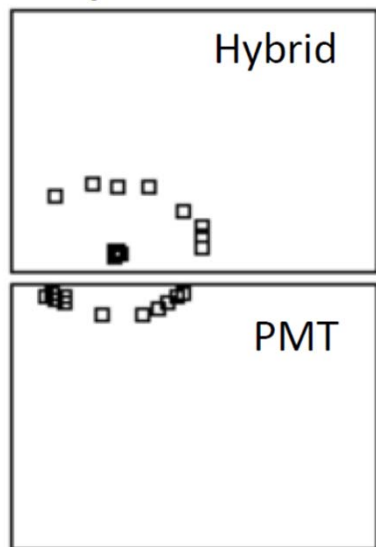
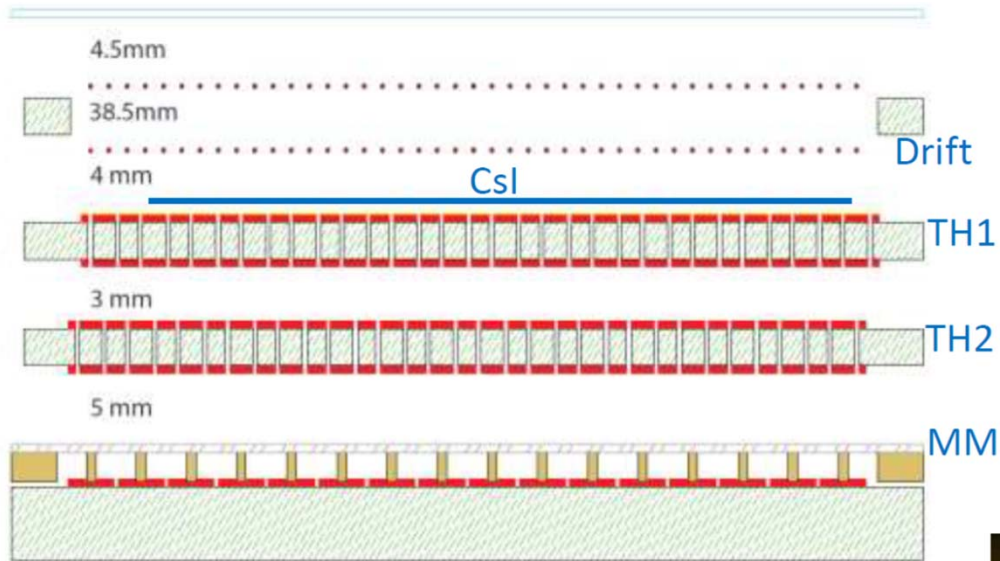

RICH for EIC: to increase the number of photons in the far UV, remove the window. → CsI might not be robust enough (humidity, ion bombardment).

Looking for alternatives: nano diamond photocathodes – interesting, but still some way to go

SiPMs as photon detectors for RICH detectors

SiPM: array of APDs operating in the Geiger mode.

Characteristics:

- low operation voltage $\sim 10\text{-}100\text{ V}$
- gain $\sim 10^6$
- peak PDE up to 65%(@400nm)
PDE = QE \times ϵ_{geiger} \times ϵ_{geo} (up to 5x PMT!)
- ϵ_{geo} – dead space between the cells
- time resolution $\sim 100\text{ ps}$
- works in high magnetic field
- dark counts \sim few 100 kHz/mm²
- radiation damage (p,n)

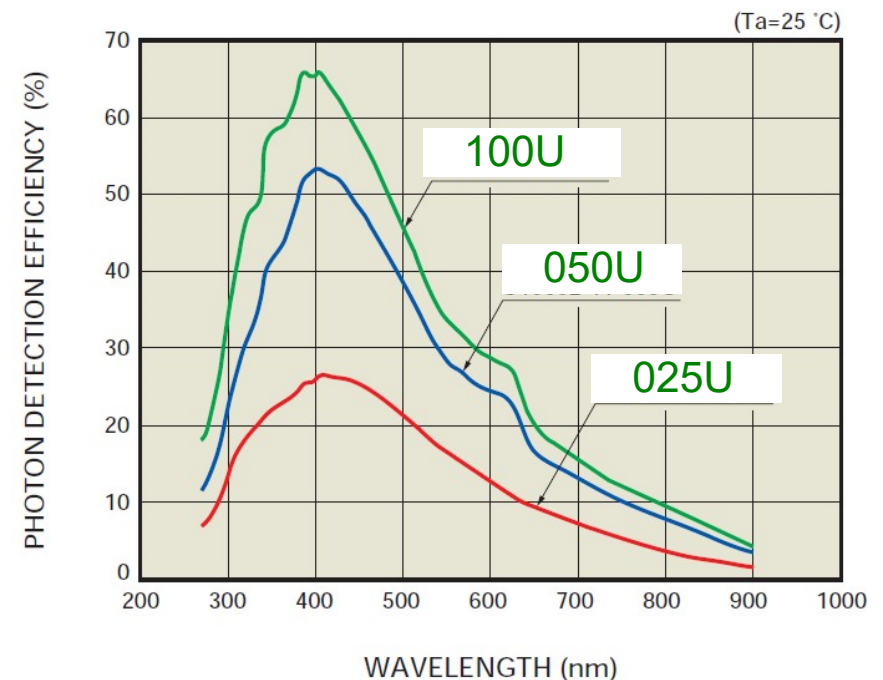

Not trivial to use in a RICH where we have to detect single photons!

Dark counts have single photon pulse heights (rate 0.1-1 MHz) – and this gets worse with n irradiation...

SiPM as photosensor for a RICH counter

Improve the signal to noise ratio:

- Reduce the noise by a narrow ($<10\text{ns}$) time window (Cherenkov light is prompt!)
- Increase the number of signal hits per single sensor by using light collectors

Example: Hamamatsu MPPC S11834-3388DF

- 8x8 SiPM array, with $5 \times 5 \text{ mm}^2$ SiPM channels
- Active area $3 \times 3 \text{ mm}^2$

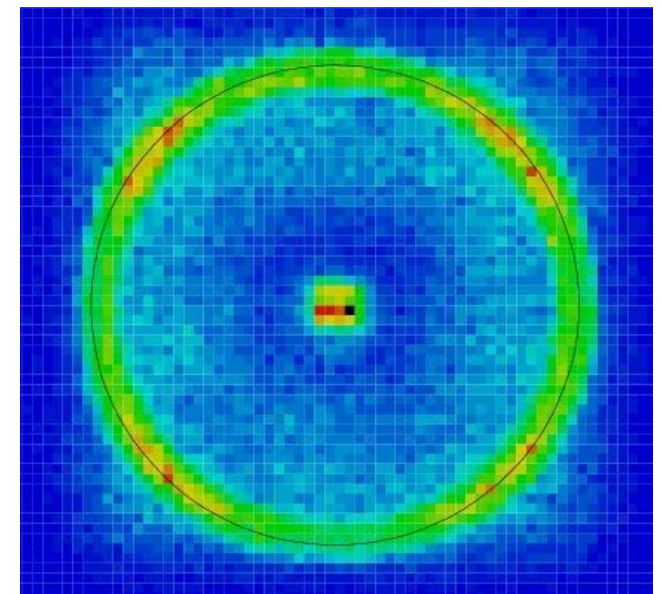
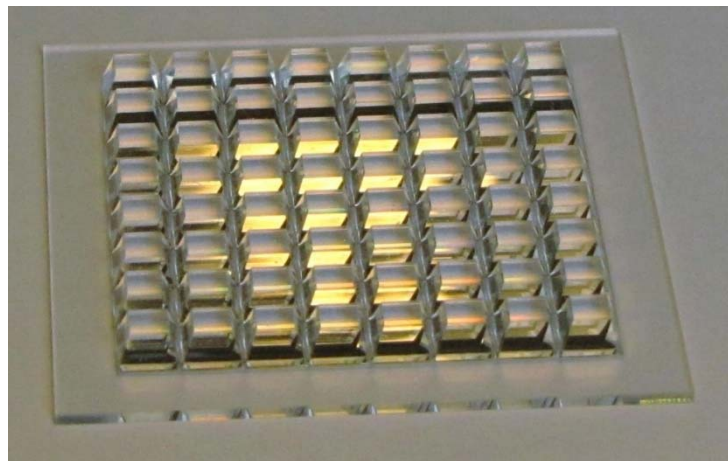
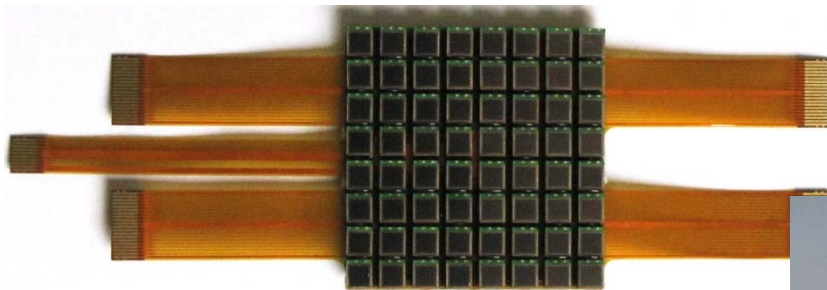

First rings with SiPMs

→ NIM A594 (2008) 13; NIM A613 (2010) 195

SiPMs: Radiation damage

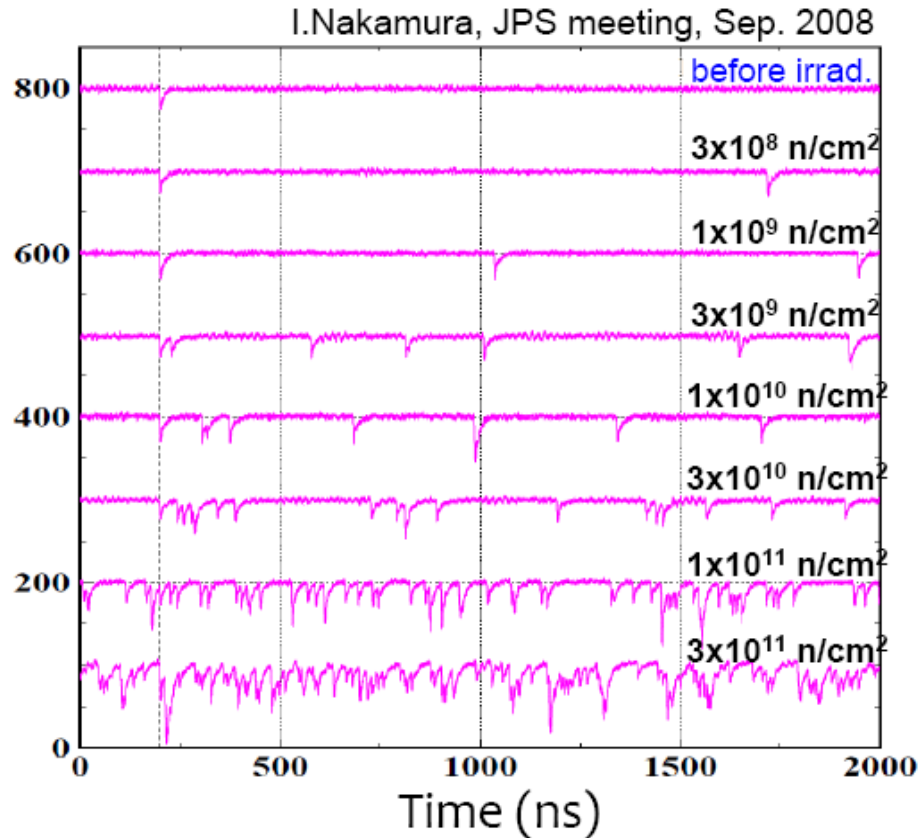

Expected fluence at 50/ab at Belle II:
 $20 \times 10^{11} \text{ n cm}^{-2}$
→ Worst than the lowest line

→ Need cooling of sensors with wave-form sampling readout electronics, and preferably also some annealing method

Considered for RICHes in the EIC detector, the next LHCb upgrade and for the Belle II upgrade by the end of the decade

Trigger development

ATLAS

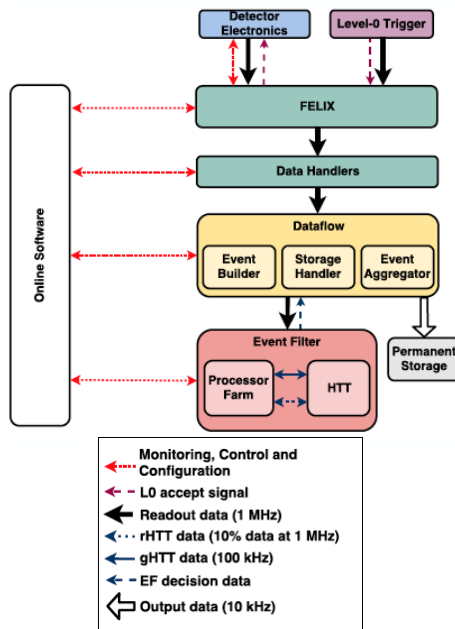

Minimize data flow bandwidth by using multiple trigger levels and regional readout (RoI)

CMS

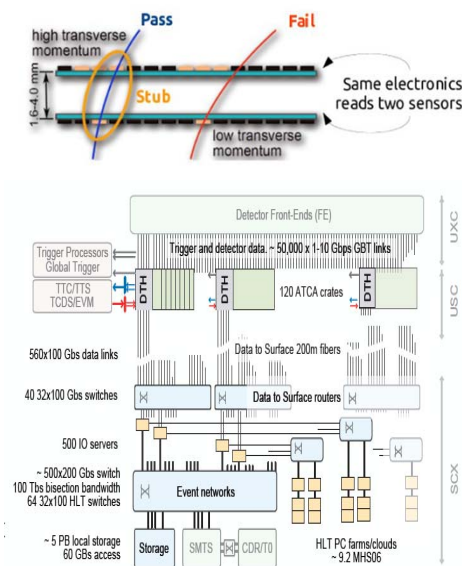

Allow large data flow bandwidth. Invest in scalable commercial network and processing systems

LHCb

40 MHz trigger-less DAQ

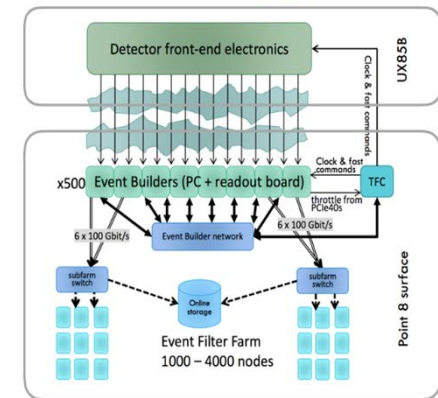

Massive use of data links

Summary

Detectors for particle physics experiments are our discovery tools – well designed and well functioning devices have been essential for our present understanding of elementary particles and their interactions.

A very vibrant research area: a large variety of new methods and techniques has either been developed recently, or is under commissioning or early data taking.

New challenges are waiting for us when planning the next generation of experiments