

ICHEP 2022
BOLOGNA

ICHEP 2022
XLI
International Conference
on High Energy Physics
Bologna (Italy)

6
13 07 2022

The Belle II Upgrade Program

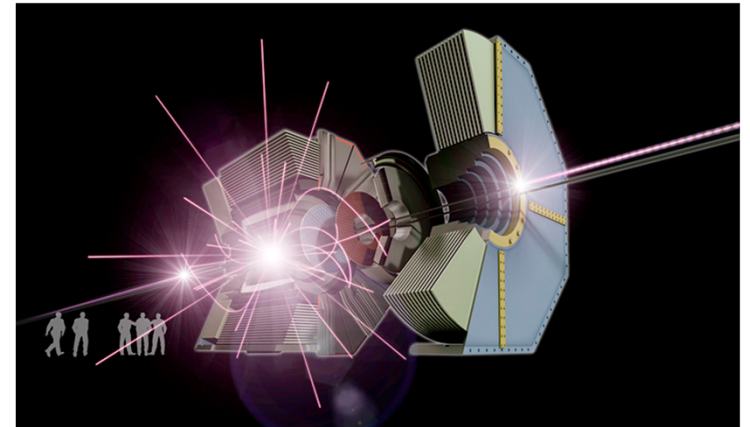

Peter Križan

University of Ljubljana and J. Stefan Institute

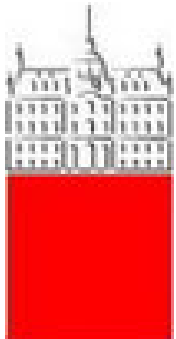

University
of Ljubljana



Jožef Stefan
Institute

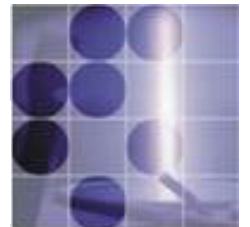



Contents



- The Belle II and SuperKEKB Program
- Timescales for upgrades
- Motivations and opportunities
- Upgrades overview
- Perspectives

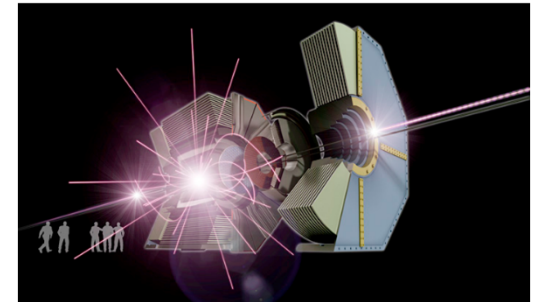

→ Cannot discuss all details; for more, check the slides of F. Forti at VCI2022

https://indico.cern.ch/event/1044975/contributions/4663661/attachments/2396099/4096983/20220223_VCI_Belle_II_upgrade.pdf

→ Belle II and Belle physics: several talks at this conference (a list in the backup slides)

KEKB → SuperKEKB



Replace short dipoles with longer ones (LER)

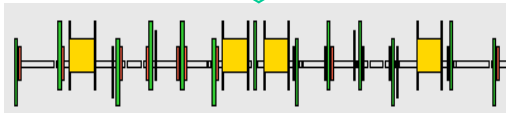
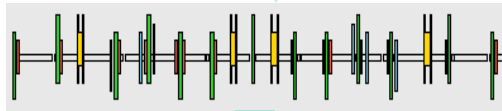

Redesign the lattices of HER & LER to squeeze the emittance

TiN-coated beam pipe with antechambers

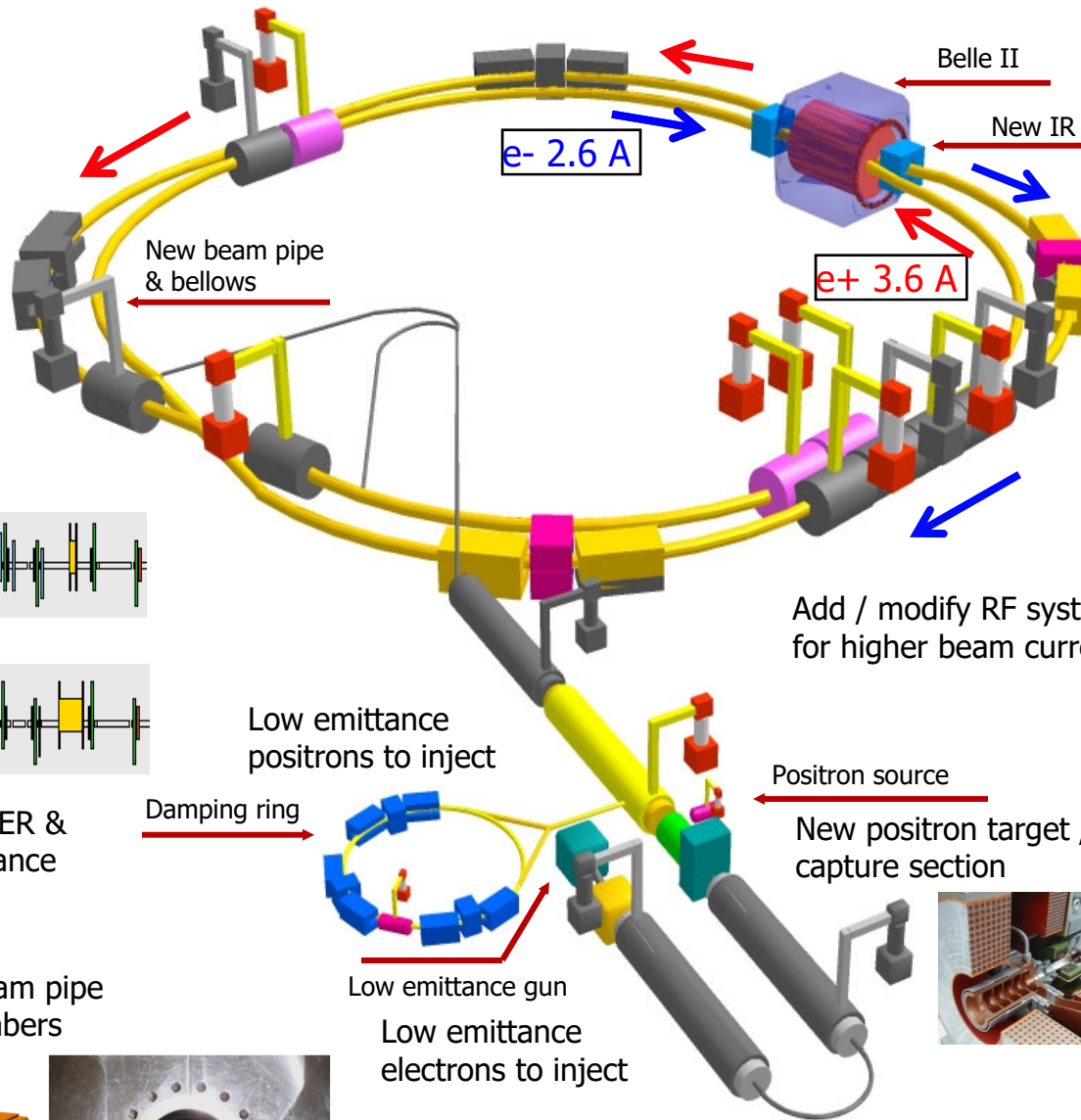
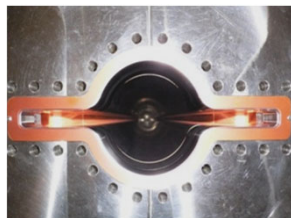
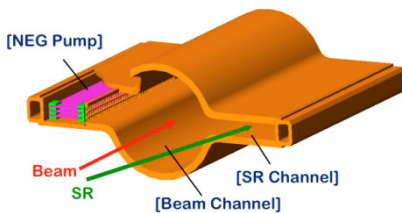

Colliding bunches
New superconducting / permanent final focusing quads near the IP

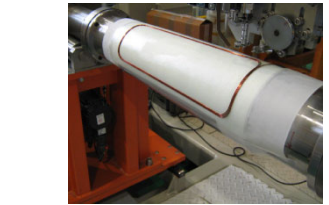

Add / modify RF systems for higher beam current



Damping ring

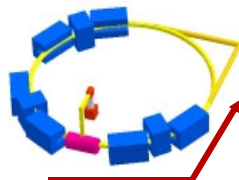

Low emittance gun
Low emittance electrons to inject

Positron source
New positron target / capture section

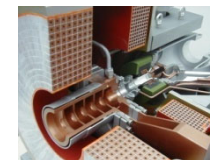

To get x30 higher luminosity

Belle → Belle II Detector

KL and muon detector:
Resistive Plate Counter (barrel outer layers)
Scintillator + WLSF + MPPC (end-caps ,
inner 2 barrel layers)

EM Calorimeter:
CsI(Tl), waveform sampling
Pure CsI (part of end-caps)

electrons (7GeV)

Particle Identification
Time-of-Propagation counter (barrel)
Prox. focusing Aerogel RICH (fwd)

Beryllium beam pipe
2cm diameter

Vertex Detector
2 layers DEPFET + 4 layers DSSD

positrons (4GeV)

Central Drift Chamber
He(50%):C₂H₆(50%), small cells, long
lever arm, fast electronics



The SuperKEKB/Belle II program

- Phase 1(2016): no detector, no collision, test the rings, baking the 3km of the accelerator vacuum chambers
- Phase 2 (2018): first collisions with complete accelerator
 - Incomplete detector: Vertex detector replaced by dedicated background detector (Beast 2)
- Phase 3 (2019-): luminosity run with complete detector
 - Pixel Detector (PXD): layer 1 + only 2 ladders in layer 2
 - Full 4-layers strip detector (SVD)
 - First physics paper appeared in January 2020
- New and difficult accelerator. Additional operational complexity during the pandemic
- Record peak luminosity $4.7 \times 10^{34} \text{ cm}^{-2} \text{ s}^{-1}$
- Path to reach $2 \times 10^{35} \text{ cm}^{-2} \text{ s}^{-1}$ identified.
- Still large factors to reach the target peak luminosity of $6 \times 10^{35} \text{ cm}^{-2} \text{ s}^{-1}$

Path to the future

Steep path to higher luminosity

A. Machine performance and stability

- Beam blow up due to beam-beam effects
- Lower than expected beam lifetime
- Transverse mode coupling instabilities
- Low machine stability
- Injector capability
- Aging infrastructure

B. Backgrounds in the detector

- Single beam: Beam-gas, Touchek,
- Luminosity: Radiative Bhabha, two-photon processes
- Injection backgrounds

Mitigation measures

A. Consolidate machine

- International task force at work to help
- Many countermeasures under development
- A major redesign of the Interaction Region may be required to go beyond $\sim 2 \times 10^{35} \text{ cm}^{-2} \text{ s}^{-1}$

B. Consolidate the detector

- Install a complete PXD
- Complete installation of more robust TOP PMTs

C. Improve detector

- Upgrade program to make the detector more robust against backgrounds and with improved performance
-

Timeline of upgrade work

Long Shutdown 1 (LS1) - 2022-23

- Motivated by the installation of a complete PXD.
- Just started

Long Shutdown 2 (LS2): end of 2026 or 2027

- Motivated by a (still to be defined) redesign of the IR, with superconducting quadrupole replacement.
- Window of opportunity for significant detector upgrades, but large uncertainties
- Prepare technology choice for a full VXD replacement

Longer term upgrades: >2032

- Not clear at this time how to realize a significant luminosity increase
- Study the physics case and start technology R&D for an extreme-luminosity detector
- Interesting possibility of beam polarization under active study; maybe possible on a more rapid timescale

Status and plan

- LS1 just started to replace VXD. There will be other maintenance/improvement work on machine and detector.
- We resume machine operation from fall 2023.
- An International Taskforce is discussing additional improvements needed for the operation in the target scenario (displayed below).

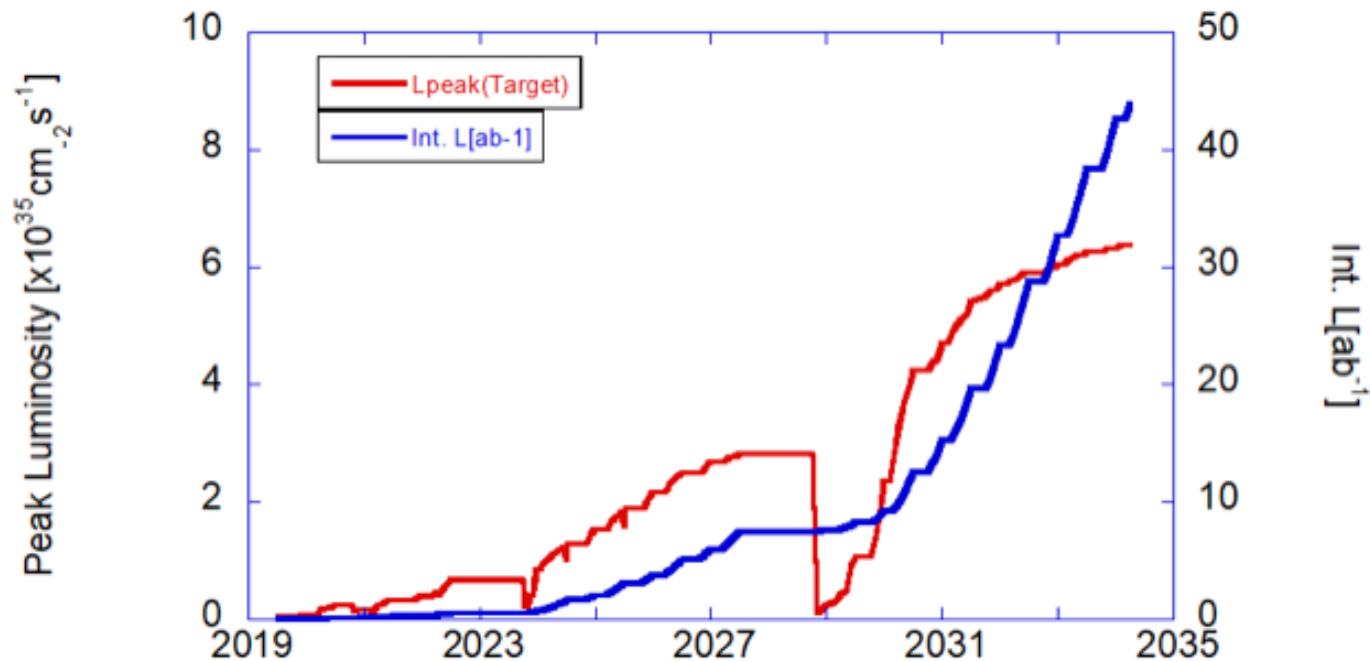

Motivation for Belle II upgrades



Improve detector robustness against backgrounds

- Provide larger safety factors for running at higher luminosity

Increase longer term subdetector radiation resistance

Develop the technology to cope with different future paths

- For instance if a major IR redesign is required to reach the target luminosity

Improve physics performance: get more physics per ab^{-1} .

A number of ideas are being developed and reviewed internally for the different time scales

Logo: Copyright F. Forti

Belle II Upgrades

- During LS2
- Options beyond LS2

ECL: Crystal replacement with pure CsI and APD; pre-shower; replace PIN-diodes with APD photosensors.

KLM: Replacement of barrel RPC with scintillators, upgrade of readout electronics, possible use as TOF

TOP: Replace readout electronics to reduce size and power, replacement of MCP-PMT with extended lifetime ALD PMT, study of SiPM photosensor option

STOPGAP: Study of fast CMOS to close the TOP gaps and/or provide timing layers for track trigger

ARICH: possible photosensor upgrade

electrons (7GeV)

QCS replacement and IR redesign

VXD: options
- DEPFET
- Thin Strips
- SOI-DUTIP
- DMAPS

CDC: Replacement of the readout electronics (ASIC, FPGA) to improve radiation tolerance and x-talk

positrons (4GeV)

TRIGGER: Take advantage of electronics technology development. Increase bandwidth, open possibility of new trigger primitives



Upgrades main ideas and time scale

EOI	Upgrade ideas scope and technology	Time scale
DEPFETs	Adiabatically improved replacement of existing PXD system	LS2
DMAPS	Fully pixelated Depleted CMOS tracker, replacing the current VXD. Evolution from ALICE ITS developed for ATLAS ITK.	LS2
SOI-DUTIP	Fully pixelated system replacing the current VXD based on Dual Timer Pixel concept on SOI	LS2
Thin Strips	Thin and fine-pitch double-sided silicon strip detector system replacing the current SVD and potentially the inner part of the CDC	LS2
CDC	Replacement of the readout electronics (ASIC, FPGA) to improve radiation tolerance and x-talk	< LS2
TOP	Replace readout electronics to reduce size and power, replacement of MCP-PMT with extended lifetime ALD PMT, study of SiPM photosensor option	LS2 and later
ECL	Crystal replacement with pure CsI and APD; pre-shower; replace PIN-diodes with APD photosensors.	> LS2
KLM	Replacement of barrel RPC with scintillators, upgrade of readout electronics, possible use as TOF	LS2 and later
Trigger	Take advantage of electronics technology development. Increase bandwidth, open possibility of new trigger primitives	< LS2 and later
STOPGAP	Study of fast CMOS to close the TOP gaps and/or provide timing layers for track trigger	> LS2
TPC	TPC option under study for longer term upgrade	> LS2

VXD Upgrade -Requirements

Radius range: R	14 – 135 mm (**)
Tracking & Vertexing performance at least as good as current VXD	
Single point resolution(*)	< 15 μm
Total material budget	< (2x 0.2% + 4x 0.7%) X_0
Robustness against radiation environment	
Hit rate(*)	$\sim 120 \text{ MHz/cm}^2$
Total Ionizing Dose(*)	$\sim 10 \text{ Mrad/year}$
NIEL fluence(*)	$\sim 5.0 \times 10^{13} \text{ n}_{\text{eq}}/\text{cm}^2/\text{year}$

* For the innermost layer at 14 mm

** Option: include the inner region of the CDC (135 mm – 240 mm)

Be prepared for a major interaction region redesign

- Allow large safety factors against backgrounds

Take advantage of technology development

Possible performance improvements

- Improve impact parameter and vertexing resolution
- Improve tracking performance for low pT tracks
- Triggering: possible contribution to the L1 trigger

VXD – several proposals under study and R&D

Thin and fine-pitch DSSD

- Sensor 140 μm thin & z-pitch < 80 μm
- New ASIC for low noise

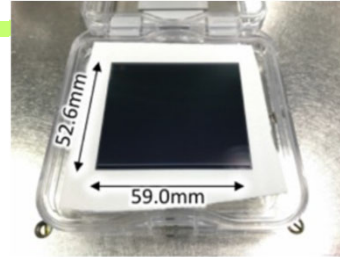

Upgraded DEPFET

- Higher radiation tolerance through higher gain
- Faster read-out (few μs) with new ASICs and a possible R/O re-orientation

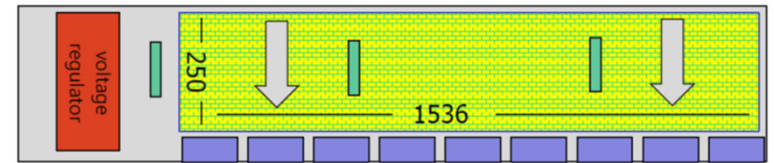

SOI pixels

- Lapis 200 nm process
- Dual Time pixel sensor (DuTiP)
- pitch 45 μm , 2x60 ns integration

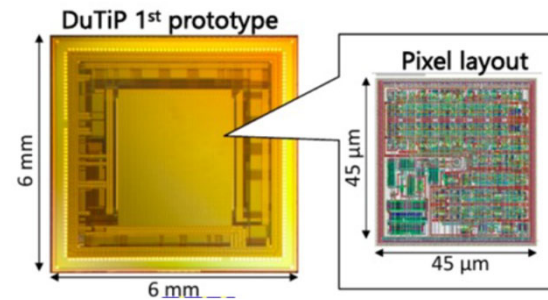

CMOS-MAPS

- Tower 180 nm process
- Extension of TJ-MONOPIX2 → OBELIX sensor
- Pitch < 40 μm with 100 ns integration
- Fully pixelated VXD concept = VTX with all-Si modules or ALICE-ITS-like ladders

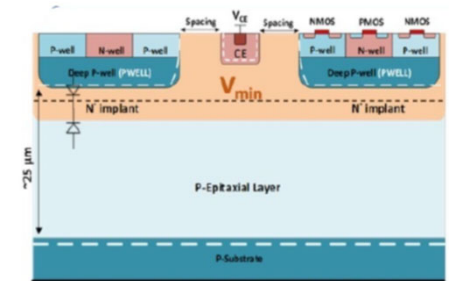

W. Snoeys et al. <https://doi.org/10.1016/j.nima.2017.07.046>

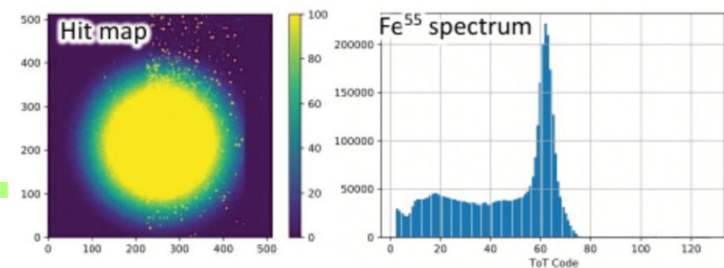

→ More details: backup slides

Tracking: CDC

Central Drift Chamber Electronics upgrade:

- Improve radiation tolerance,
- Reduce cross-talk and power consumption
- New ASIC, new FPGA, optical modules
- Installation in LS2

	the present board	upgrade	status
power consumption (ASIC of ASD)	separated chips, ASD and FADC	functions of ASD and FADC are in one chip. ~60% reduction is expected in ASD+FADC	design is almost finalized (M. Miyahara, KEK Esys) mass production from 2023
cross talk (ASIC of ASD)	~100mV pulse height induced in neighbor ch with 7pC input	~10mV pulse height induced in neighbor ch with 7pC input + double thresholds	
FPGA soft error	Virtex-5	Kintex-7	purchased and fabricated on the prototype board. irradiation test is planed in 2022.
radiation tolerance of optical transceiver	SFP for DAQ (1kGY) Avago HFBR-7934WZ for TRG (300-400Gy)	QSFP	purchased several QSFPs to be tested with irradiation
bandwidth of optical transceiver	SFP for DAQ Avago HFBR-7934WZ for TRG (3.125Mb/s)	one QSFP in stead of two different optical transceivers	basic test is done with TRG system

Long-term studies

- Sustaining higher rates & backgrounds
→ Exploring options
- Extended VTX
- TPC tracker with pixel read-out Gridpix-like $200^2 \mu\text{m}^2$

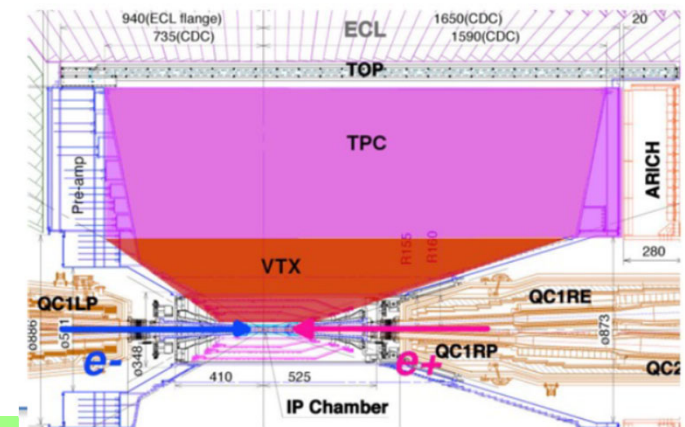

PID: TOP

Install Life-extended Atomic Layer Deposition MCP PMTs

- in LS1 for standard MCP PMT,
- possibly in LS2 for ALD MCP PMTs

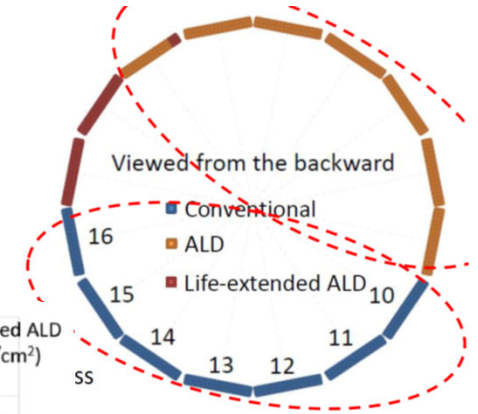
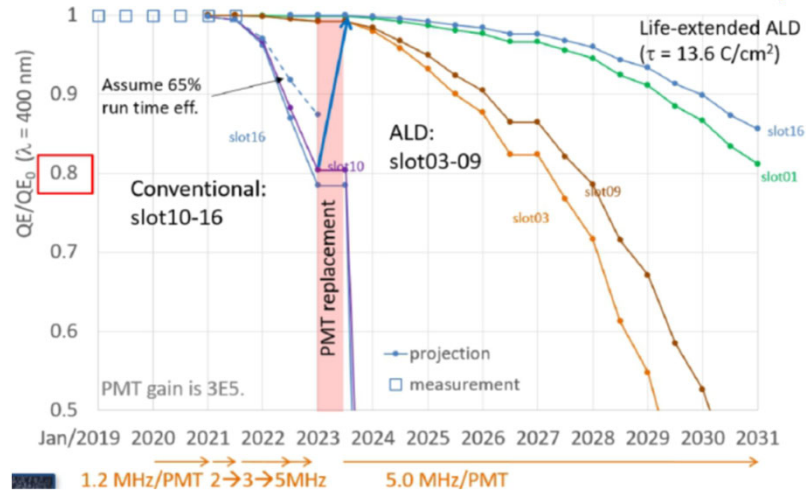

Study of SiPM as possible MCP PMT replacement

- Require cooling system
- Longer time scale

Electronics upgrade

- IRSX ASIC 8-channel 250 μm CMOS
- TOPSoC ASIC 32-channel 130 μm CMOS
- Feature extraction inside ASIC
- Reduced power consumption

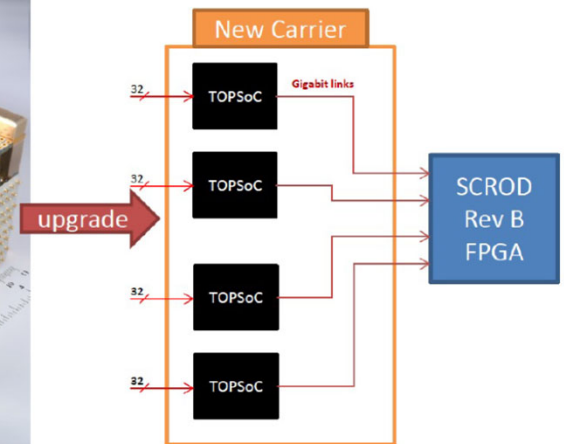
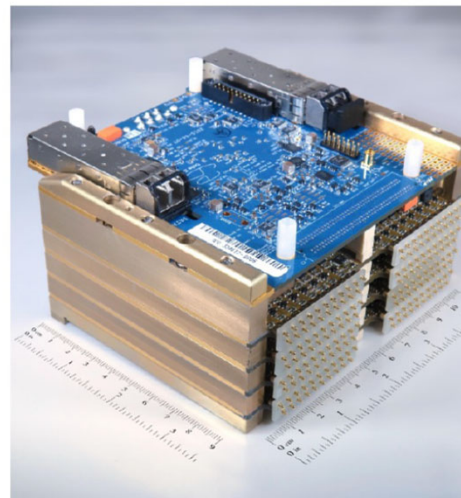

PID: ARICH

No modifications planned for the LS1+LS2.

Long term studies:

-Photon detector upgrade (SiPMs or MCP-PMTs/LAPPD)

- SiPMs: irradiation tests underway of various Hamamatsu sensors
- LAPPD 20cm x 20cm at hand since end of Dec 2021, first studies
- Read-out: two options under study, custom development and FASTiC (developed for the next upgrade of LHCb RICHes)

-Impact of possible aerogel upgrade is under investigation

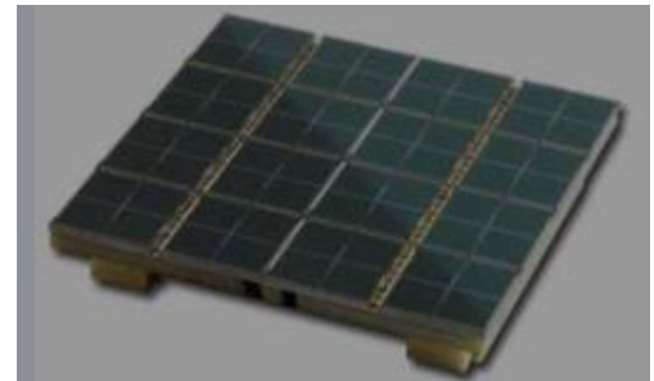
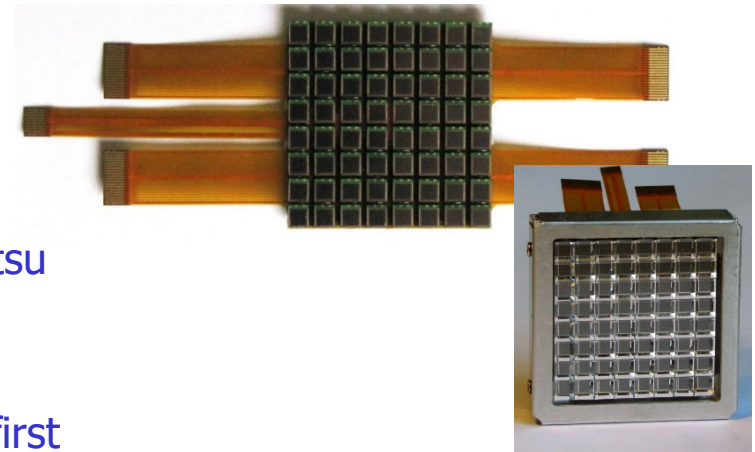

PID: STOPGAP

Take advantage of development of fast CMOS sensors

1) Proposal to fill the gaps in the TOP detector with a $\sim 1\text{cm}^2$ granularity: improve K detection efficiency in TOP by covering the full solid angle - kaon ID coverage increased by O(10%).

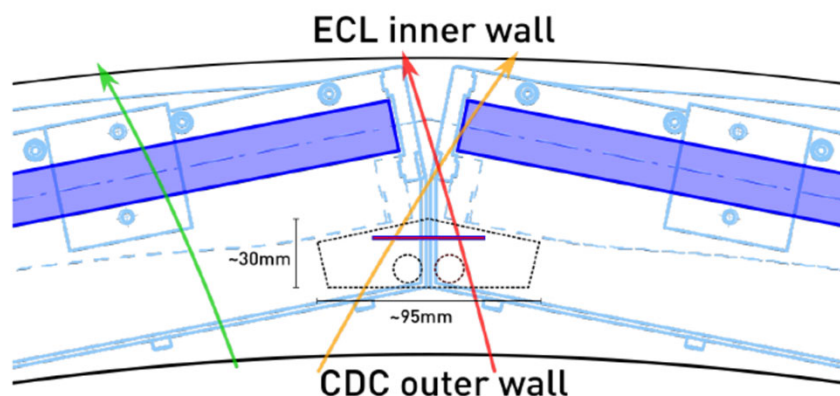

2) Proposal to add one or two full timing layers at lower radii (250mm, 450mm) to provide PID for low momenta in the context of a larger VXD; trigger

Interesting concept for longer term upgrades. R&D needed

Calorimetry: ECL

Hypotheses for long term upgrades

CsI(Tl) --> pure CsI

- Improves pile-up
- WLS employed to improve

Equivalent Noise Energy

Preshower detector

- Help reduce background and pileup
- Determine photon direction, timing

PiN diodes --> APDs

- Reduce ENE, improve resolution

All complex and expensive options

→ Longer time scale

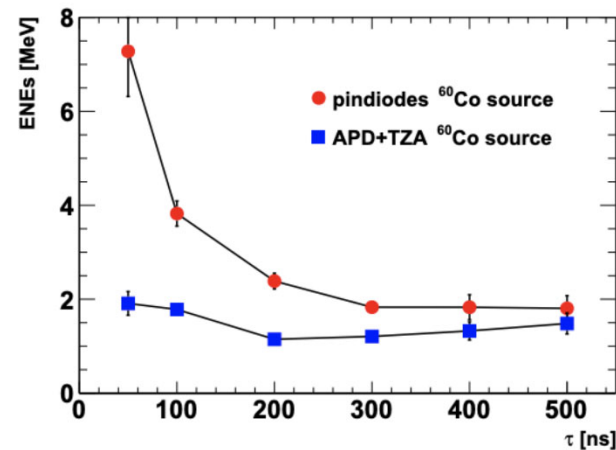
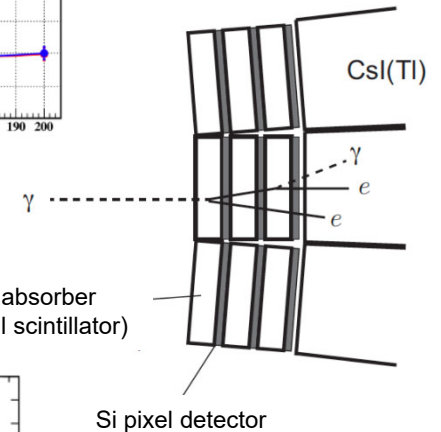
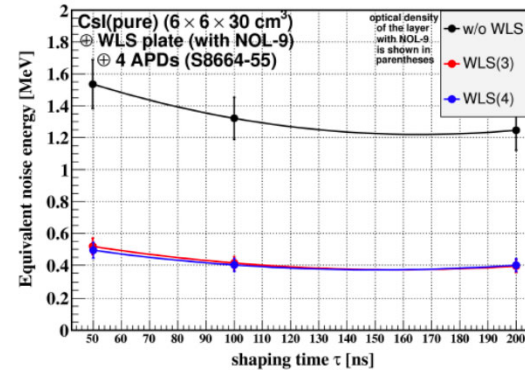

Muon and K_L detector: KLM

RPCs → scintillator bars + WLS fiber + SiPM

- Already done in first layers and endcap
- Increase rate capability

Readout electronics upgrade

- More compact readout
- Data push architecture possible

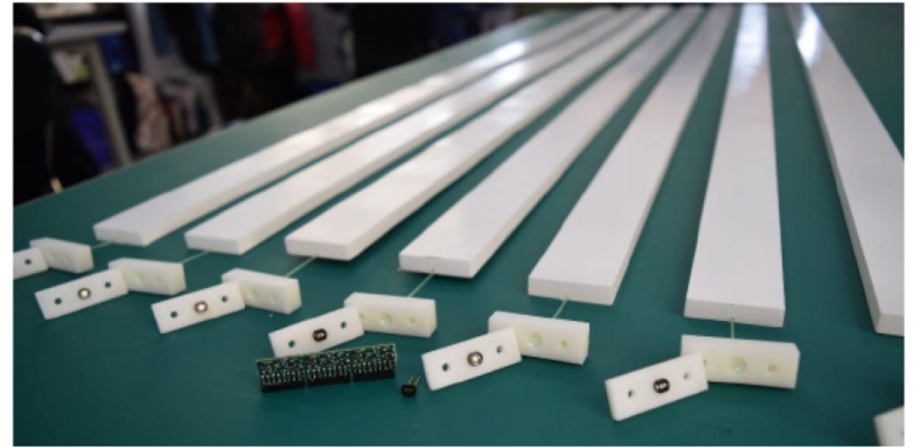

Possible use as TOF detector

- Required time resolution around 100ps
- Improve K_L identification
- Ongoing studies of scintillators and SiPM readout arrangement for high time resolution

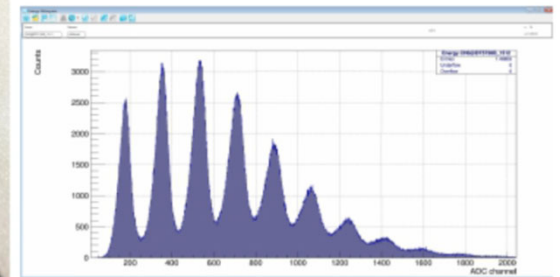
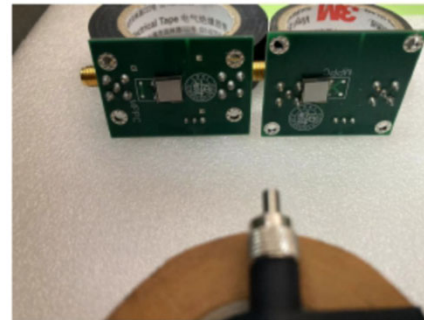

SiPM sensors with newly designed PAs, tested by laser light

Trigger

Upgrade

- More powerful UT4 board for new CDC Front End
- Avoid merger boards, more bandwidth, use all CDC TDC and ADC information
- Many trigger improvements possible.
- Detailed technical documents in preparation

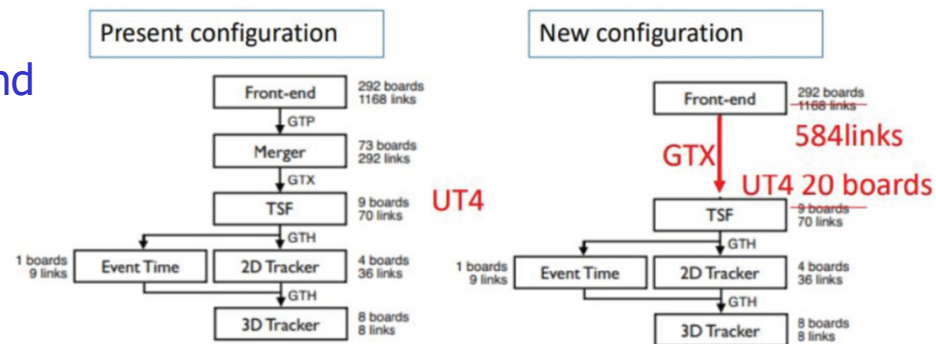

Component	Feature	Improvement	Time	#UT
CDC cluster finder	transmit TDC and ADC from all wires with the new CDC front end	beamBG rejection	2026	10
CDC 2Dtrack finder	use full wire hit patterns inside clustered hit	increase occupancy limit	2022	4
CDC 3Dtrack finder	add stereo wires to track finding	enlarge θ angle acceptance	2022	4
CDC 3Dtrack fitter (1)	increase the number of wires for neural net training	beamBG rejection	2025	4
CDC 3Dtrack fitter (2)	improve fitting algorithm with quantum annealing method	beamBG rejection	2025	4
Displaced vertex finder	find track outside IP originated from long lived particle	LLP search	2025	1
ECL waveform fitter	improve crystal waveform fitter to get energy and timing	resolution	2026	–
ECL cluster finder	improve clustering algorithm with higher BG condition	beamBG rejection	2026	1
KLM track finder	improve track finder with 2D information of hitting layers	beamBG rejection	2024	–
VXD trigger	add VXD to TRG system with new detector and front end	BG rejection	2032	–
GRL event identification	implement neural net based event identification algorithm	signal efficiency	2025	1
GDL injection veto	improve algorithm to veto beam injection BG	DAQ efficiency	2024	–

Table 14: TRG firmware upgrade plan.

Polarized electron beam

Physics case: precision $\sin^2\theta_W$ measurements at $\sim 10\text{GeV}$ with b, c, e, μ & τ , probing its running and universality.

Planning 70% polarization with 80% polarized source

New hardware for the polarization upgrade:

- **Low emittance polarized Source:** electron helicity can be flipped bunch-to-bunch by controlling circular polarization of source laser illuminating a GaAs photocathode. Inject vertically polarized electrons into the 7 GeV e- Ring, needs low enough emittance source to be able to inject.
 - **Spin rotators:** Rotate spin to longitudinal before Interaction Point (IP) in Belle II, and then back to vertical after IP using solenoidal and dipole fields
 - **Compton polarimeter:** monitors longitudinal polarization with $<1\%$ absolute precision, provides real time polarimetry. Use tau decays from $e^+e^- \rightarrow \tau^+ \tau^-$ measured in Belle II to provide high precision absolute average polarization at IP.
- Project under active development

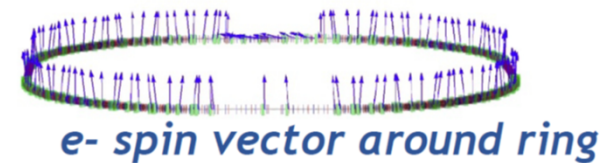
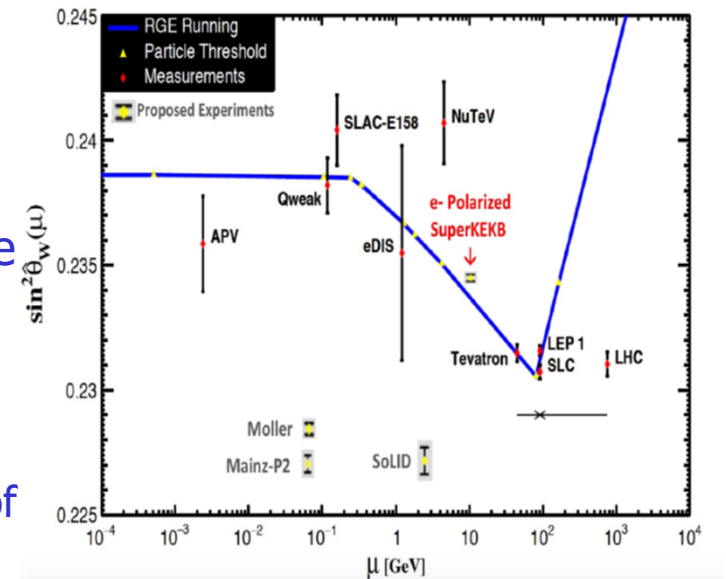

Summary and outlook

Belle II and SuperKEKB have started a successful physics run

Machine improvements are being studied and implemented to reach target luminosity

Detector upgrade ideas are being explored and R&D is in progress

- more robustness against background and radiation damage
- more physics performance
- readiness for interaction region redesign

The Belle II upgrade organization is in place

- Upgrade Working Group and Upgrade Advisory Committee have been established to help establish priorities and direct the effort
- Belle II Upgrades Whitepaper have been submitted to Snowmass process

The transition to a construction project is needed soon

- SuperKEKB International Task Force should reach conclusion by summer 2022
- The preparation of an Upgrades Conceptual Design Report should start afterwards, ready in 2023

Longer term perspectives

- Important to start exploring a longer term plan for SuperKEKB and Belle II

There is lots of physics at high luminosity

Additional slides

Belle II and Belle talks at ICHEP2022

Belle II

Nisar Nellikunnummel "Measurement of charm lifetimes at Belle II" (invited)

Henrik Junkerkalefeld "Recent Belle II results on semitauonic decays and tests of lepton-flavor universality" (invited)

Justin Skorupa "Recent Belle II results on hadronic B decays" (invited)

Francesco Tenchini "Recent tau-lepton results at Belle II" (invited)

Enrico Graziani "Recent dark-sector results at Belle II" (invited)

Eldar Ganiev "Recent Belle II results on electroweak penguins" (invited)

Chiara La Licata "Recent Belle II results on decay-time-dependent CP violation" (invited)

Qingping Ji "Recent quarkonium results at Belle II" (invited)

Taichiro Koga "Recent Belle II results on the CKM parameters $|V_{cb}|$ and $|V_{ub}|$ " (invited)

Belle

- **Kim Smith** (Melbourne) "Branching fractions and CP asymmetries in B decays through b to c process at Belle"
- **Gaetano de Marino** (IJCLab) "Search for baryon-number-violating and lepton-flavor-violating decays at Belle"
- **Markus Prim** (Bonn) "New results for semileptonic B decays from Belle"
- **Kookhyun Kang** (IPMU) "Radiative and electroweak-penguin B decays at Belle"
- **Aman Sangal** (Cincinnati) "Study of Branching fraction and CP Asymmetry of charm mesons at Belle"
- **Gian Luca Pinna Angioni** (Torino) "Study of charmonia and bottomonia at Belle"
- **Kenta Uno** (Niigata) "Tau physics at Belle"
- **Janice Chen** (NTU) "Two-Particle Correlations of Hadrons in e+e- Collisions at Belle"

CMOS DMAPS Option - Fully pixelated VXD

DMAPS in TJ 180nm

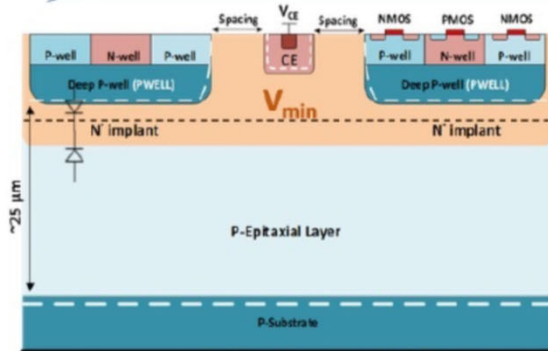

W. Snoeys et al. <https://doi.org/10.1016/j.nima.2017.07.046>

$$C_d \leq 3fF$$

$$P \approx \frac{S}{N} \approx \frac{Q}{C_d}$$

- Small sensor capacitance (C_d)
 - key for low power and noise
- Radiation tolerance challenges
 - Modified process
 - Small pixel size
- Design challenges
 - Compact, low power FE
 - Compact, efficient R/O

TJ-Monopix1

Characterization started in 2018

- Noise, threshold, gain, hit efficiency, and radiation hardness

Efficiency map

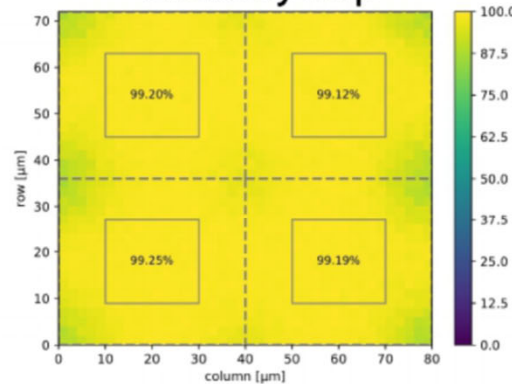

300 μm Cz: 98.6% @ 490 e^-
(with 10^{15} $n_{\text{eq}}/\text{cm}^2$ irradiation)

TJ-Monopix2

Chip size: 2x2 cm^2

Chip is alive and working

- Synchronization, configuration, DACs
- Analog pixels respond to injection
- Chip detects radiation

Analysis of beam test data on-going

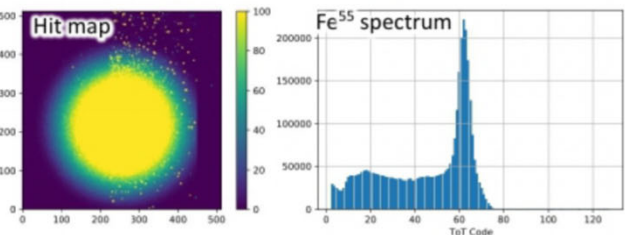
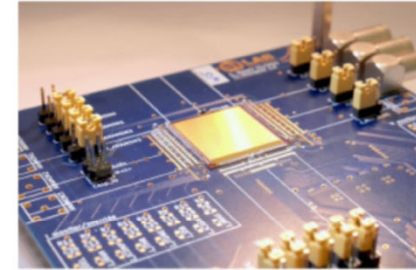

Proof-of-principle prototype

SOI Option - Fully pixelated VXD

Silicon-On-Insulator pixel (SOIPIX)

- CMOS circuit produced on silicon wafer isolated by a buried oxide (BOX) layer
 - Full depleted sensor: Fast signal, good S/N
 - Logics w/o well structure: High density, small capacitance
 - Complex circuit can be implemented in each pixel
- Produced by LAPIS semiconductor

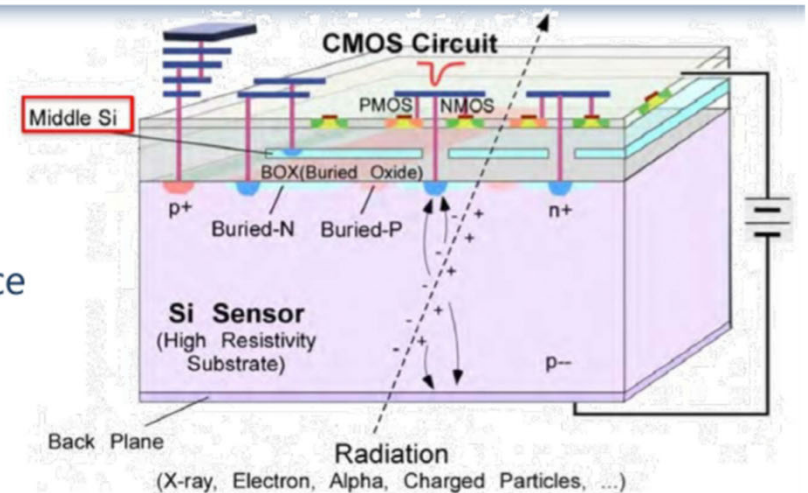

Dual Timer Pixel (DuTiP) sensor

- Alternative operation of two timers allows the next hit before the trigger arrival for the previous hit.
- Target thickness: 50um
- Prototype sensor produced
 - Modified ALPIDE (low power) analog circuit
 - Basic in-pixel digital circuit
 - Performance evaluation is on going

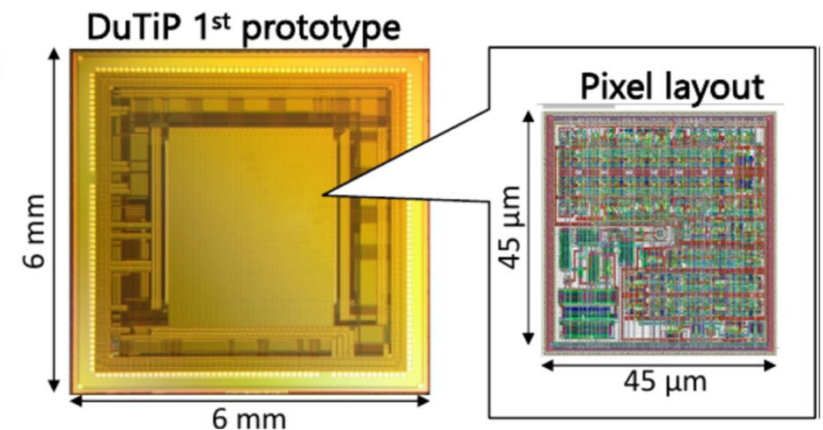

DEPFET Option - Replace PXD

- **Current Belle II PXD**

- First use of the technology in HEP experiment
- Current integration time: 20 μs

- **Sensor R&D**

- Gain increase with shorter FET length L
 - higher amplification in pixel → thinner oxide → [improved radiation tolerance](#)
- Extend Cu interconnection layer into pixel array
 - improve the signal integrity of fast signals (e.g. "clear" and "gate")

$$g = \frac{dI_{\text{drain}}}{dQ} \propto \sqrt{\frac{t_{\text{ox}}}{L^3}}$$

- **ASIC R&D**

- Faster driving and readout circuit
 - [Integration speed x2](#)

- **More aggressive option**

- Rotate readout direction of pixel array by 90°
 - Additional improve on [integration speed x3](#)

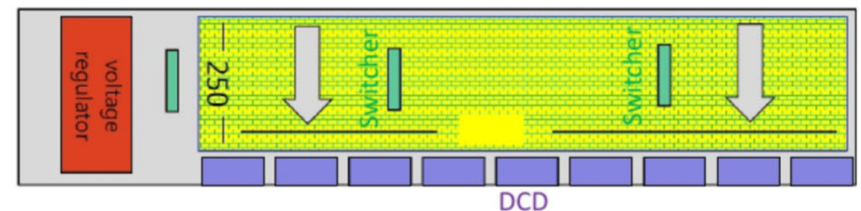
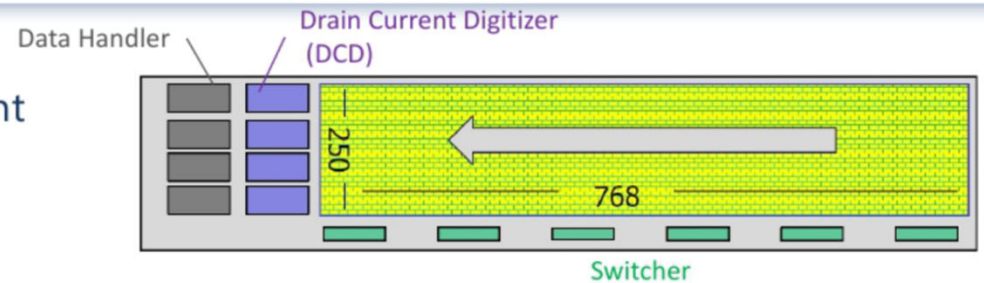

Thin DSSD option - replace SVD

Thin/fine-pitch SVD (TFP-SVD) concept

Targets

- Outer layers
- Handle higher hit-rate
 - $O(1\text{MHz}/\text{cm}^2)$ $R > 4\text{cm}$
- Improve tracking/ K_S vertexing performance



Thin DSSD sensor (Micron)

Thinner sensor: 140 μm

Finer N-side strip pitches than SVD: $\sim 85\mu\text{m}$

Develop new front-end ASIC (SNAP128A)

→ R&D challenges in front-end

- Small noise : $\sim 640e^-$ @ $C_{\text{det}}=12\text{pF}$ (simulation)
- Small heat dissipation: $\sim 330\text{mW}$
- Short signal pulse width : $\sim 60\mu\text{s}$

- Basic characterization of prototype sensors
 - Reasonable I-V and C-V curves
 - Thickness: $148 \pm 5\mu\text{m}$
 - Full depletion voltage: $14 \pm 1\text{V}$
- Performance evaluation of prototype ASIC on going

DSSD prototype

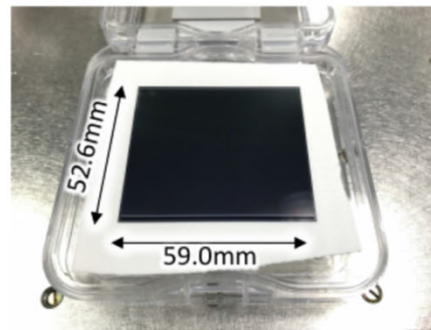

TFP-SVD DSSD layout

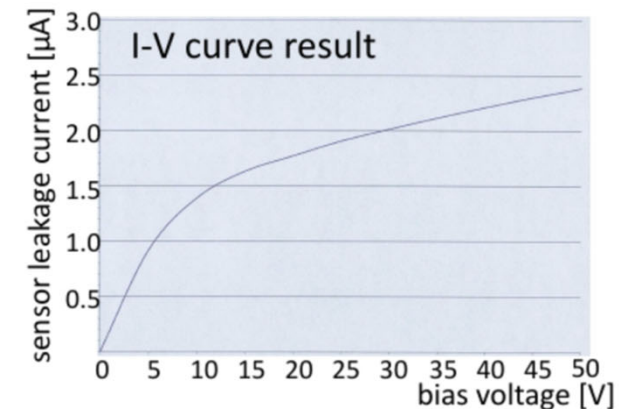
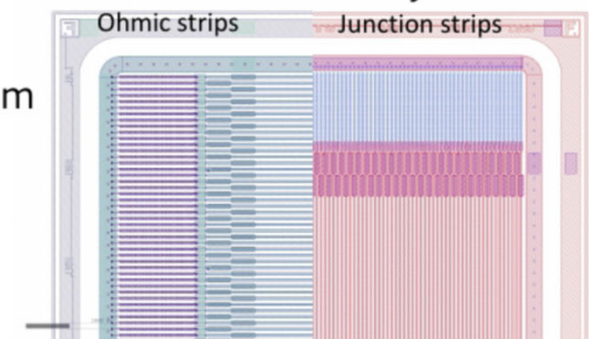

Physics and performance challenges

Identify crucial performance challenges impacting physics reach

- Tracking at low momentum
- Vertex and IP resolution
- Calorimetry energy resolution and lepton ID
- Trigger efficiency
- K/π separation
- K_L detection

Topic	VXD	CDC	PID	ECL	KLM
Low momentum track finding	✓	✓			
Track p , M resolution		✓			
IP/Vertex resolution	✓				
Hadron ID		✓	✓		
K_L^0 ID				✓	✓
Lepton ID		✓		✓	✓
π^0 , γ				✓	
Trigger	✓	✓			

TABLE II. Key performance requirements vs subdetector upgrades.

Topic	VXD	CDC (i)	PID	PID Ω	ECL	KLM
$\mathcal{B}(B \rightarrow \tau\nu, B \rightarrow K^{(*)}\nu\bar{\nu})$	✓			✓	✓	✓
$\mathcal{B}(B \rightarrow X_u l\nu)$	✓			✓		✓
$R, P(B \rightarrow D^{(*)}\tau\nu)$	✓				✓	
FEI	✓	✓				
$S, C(B \rightarrow \pi^0\pi^0, K_S^0\pi^0)$	✓	✓			✓	
$S, C(B \rightarrow \rho\gamma)$		✓			✓	
$S, C(B \rightarrow J/\psi K_S^0, \eta' K_S^0)$	✓	✓				
Flavour tagger	✓		✓			
τ LFV		✓			✓	
Dark sector searches					✓	✓

TABLE III. Selected key physics channels and the subdetector upgrades that would make substantial impacts to measurement reach.