

Danube School on Instrumentation in
Elementary Particle & Nuclear Physics
University of Novi Sad, Serbia,
September 8th-13th, 2014.



Challenges of B Physics

Peter Križan

University of Ljubljana and J. Stefan Institute



Contents

- Highlights from B factories (+ a little bit of history)
- Physics case for a next generation B physics experiment
- Super B factory
- Accelerator
- Detector
- Status and outlook

A little bit of history...

CP violation: difference in the properties of **particles** and their **anti-particles**
– first observed in 1964 in the decays of neutral kaons.

M. Kobayashi and T. Maskawa (1973): **CP violation** in the Standard model – related to the weak interaction **quark transition matrix**

Their theory was formulated at a time when three quarks were known – and they requested the existence of three more!

The last missing quark was found in 1994.

... and in 2001 two experiments – Belle and BaBar at two powerfull accelerators (B factories) - have further investigated CP violation and have indeed proven that it is tightly connected to the quark transition matrix

M. Kobayashi and T. Maskawa: CP violation in the Standard model is related to the weak interaction quark transition matrix

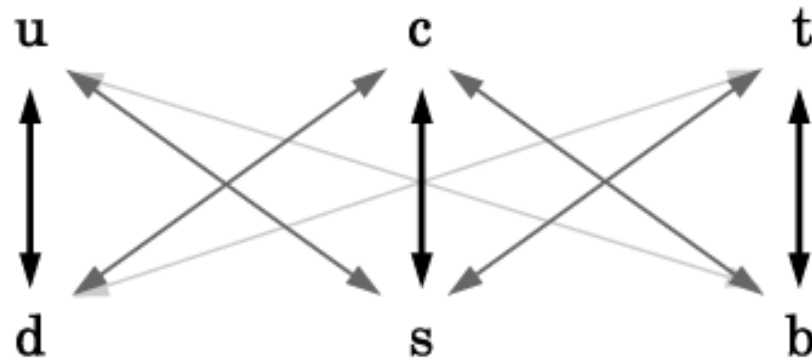

Transitions between members of the same family much more probable (=thicker lines) than others

CKM - Cabibbo-Kobayashi-Maskawa (quark transition) matrix:

unitary matrix, almost real and almost diagonal, but not completely!

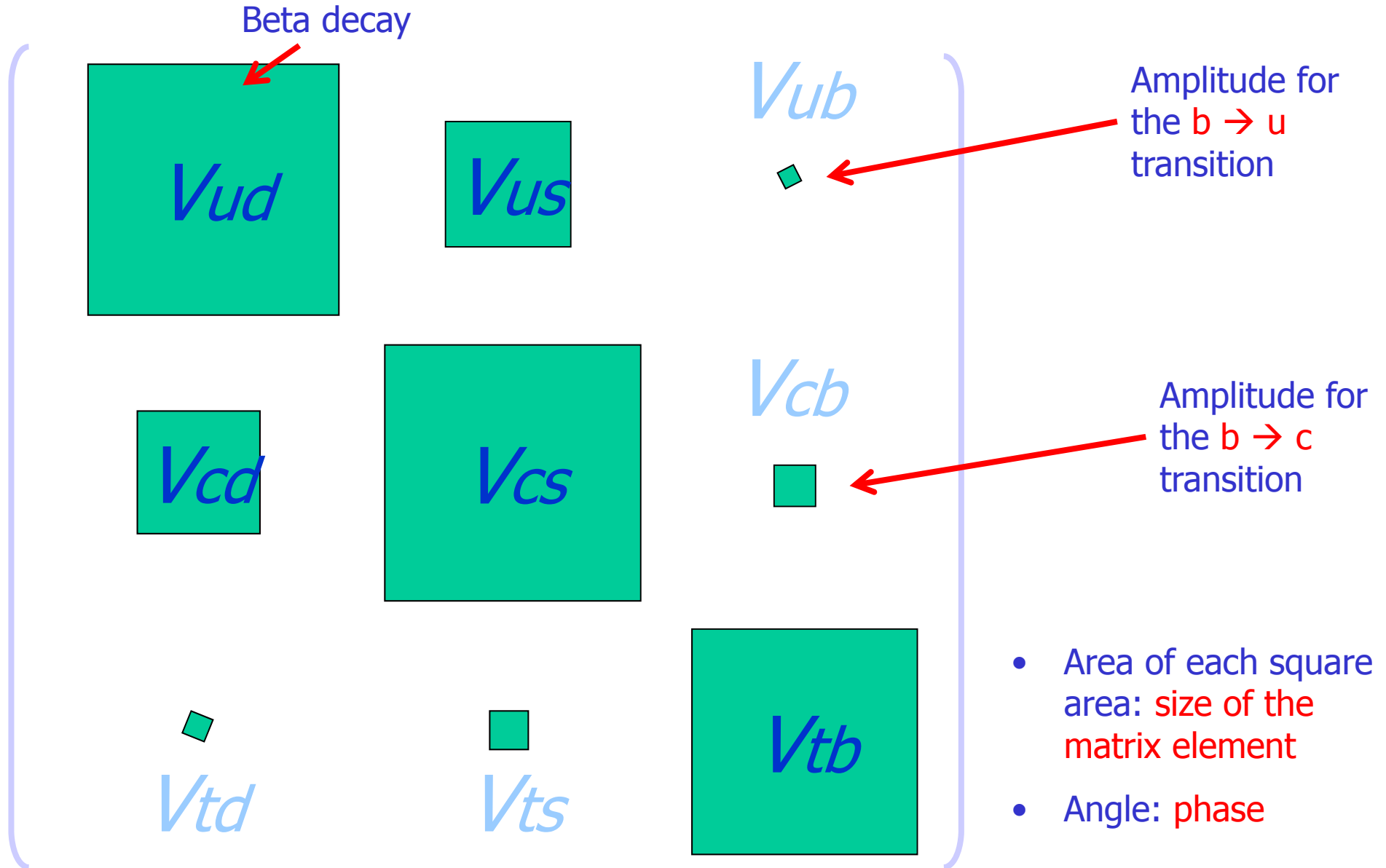

CKM matrix: determines charged weak interaction of quarks

Wolfenstein parametrisation: expand the CKM matrix in the parameter λ ($=\sin\theta_c=0.22$)

A , ρ and η : all of order one

$$V = \begin{pmatrix} 1 - \frac{\lambda^2}{2} & \lambda & A\lambda^3(\rho - i\eta) \\ -\lambda & 1 - \frac{\lambda^2}{2} & A\lambda^2 \\ A\lambda^3(1 - \rho - i\eta) & -A\lambda^2 & 1 \end{pmatrix} + O(\lambda^4)$$

determines probability of $b \rightarrow u$ transitions

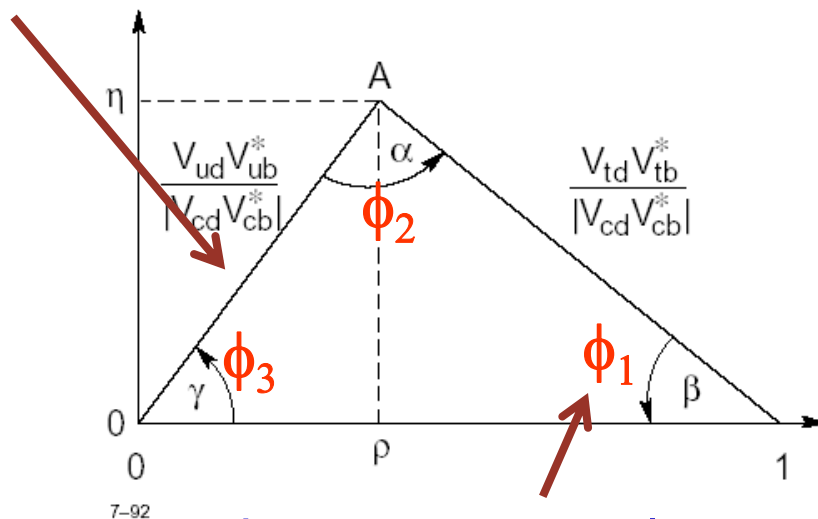

determines CP violation in $B \rightarrow J/\psi K_S$ decays

Unitarity condition:

$$V_{ud} V_{ub}^* + V_{cd} V_{cb}^* + V_{td} V_{tb}^* = 0$$



Goal: measure sides and angles in several different ways, check consistency →

Asymmetric B factories

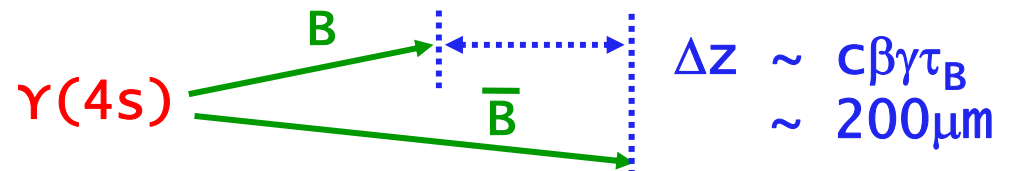
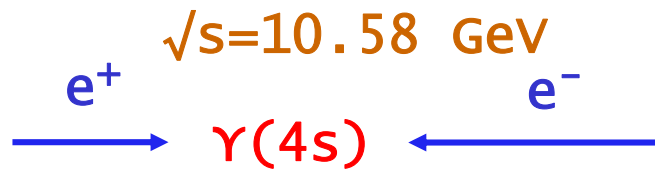
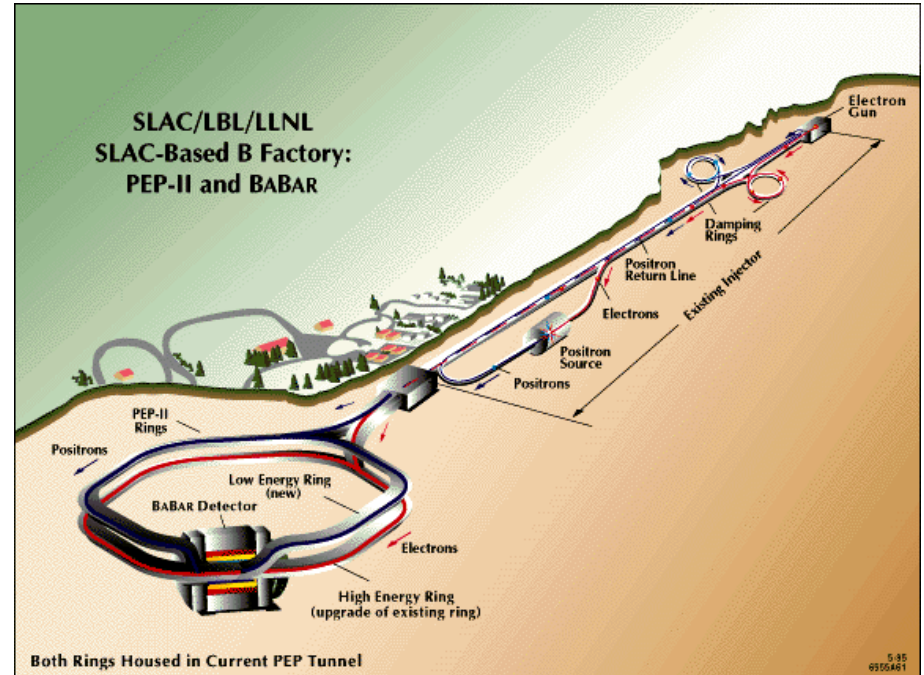
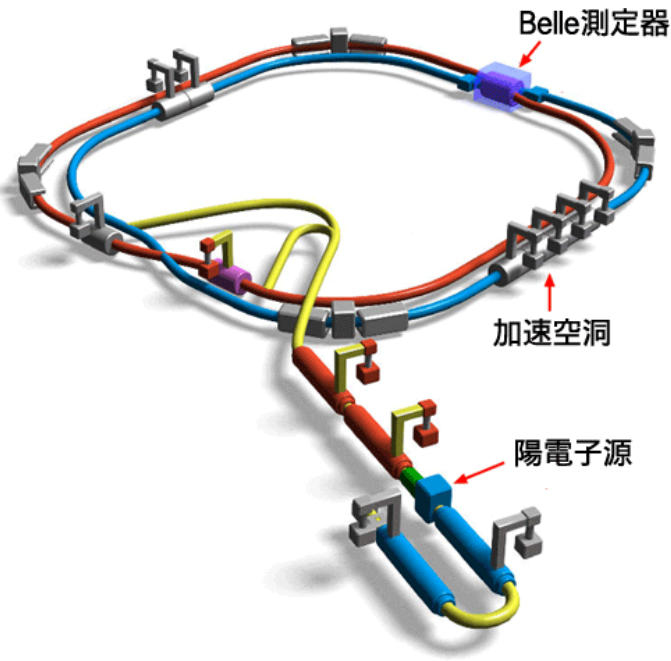

BaBar $p(e^-) = 9 \text{ GeV}$ $p(e^+) = 3.1 \text{ GeV}$

$\beta\gamma = 0.56$

Belle $p(e^-) = 8 \text{ GeV}$ $p(e^+) = 3.5 \text{ GeV}$

$\beta\gamma = 0.42$

Unitarity triangle – 2011 vs 2001

CP violation in the B system: from the **discovery** (2001) to a **precision measurement** (2011).

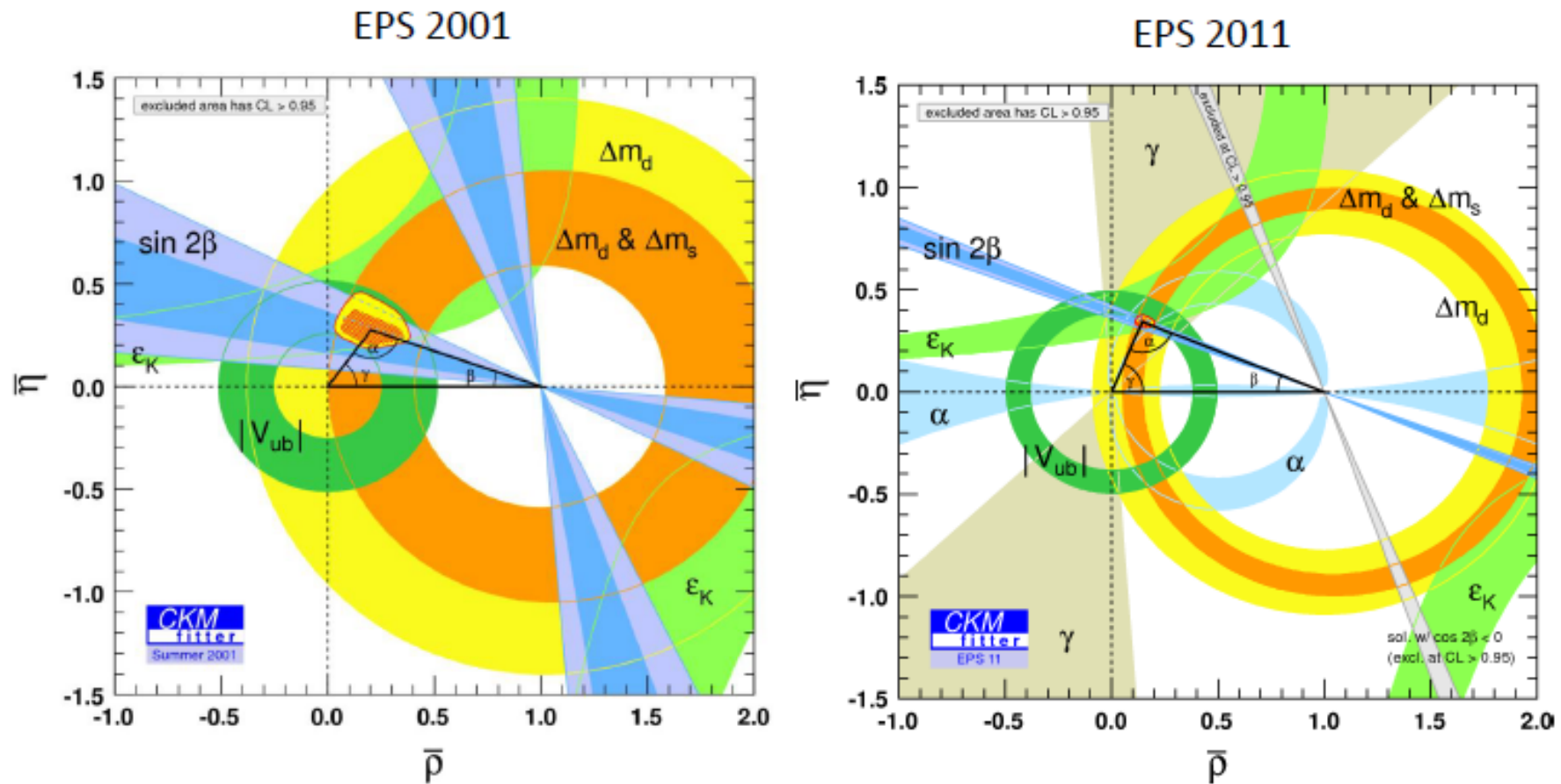

KM's bold idea verified by experiment

Relations between parameters
as expected in the Standard
model →

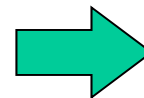
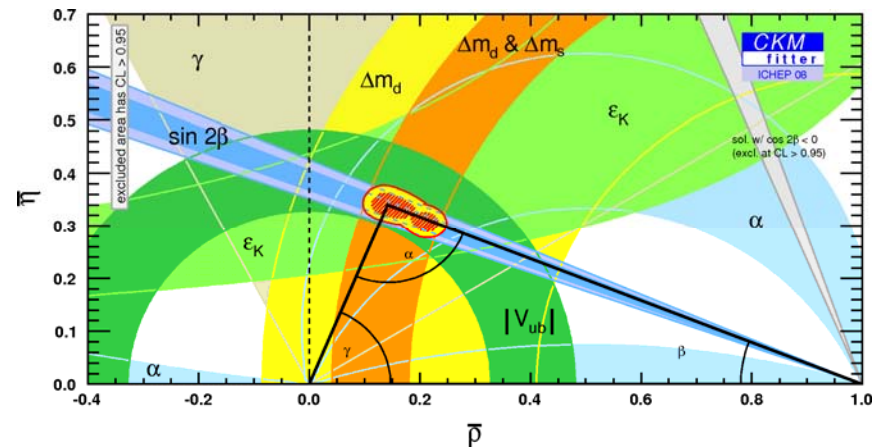

Nobel prize 2008!

→ With essential experimental confirmations by BaBar and Belle! (explicitly noted in the Nobel Prize citation)

B factories: a success story

- Measurements of CKM matrix elements and angles of the unitarity triangle
- Observation of direct CP violation in B decays
- Measurements of rare decay modes (e.g., $B \rightarrow \tau \nu$, $D \tau \nu$)
- $b \rightarrow s$ transitions: probe for new sources of CPV and constraints from the $b \rightarrow s \gamma$ branching fraction
- Forward-backward asymmetry (A_{FB}) in $b \rightarrow s l^+ l^-$ has become a powerful tool to search for physics beyond SM.
- Observation of D mixing
- Searches for rare τ decays
- Observation of new hadrons

The KM scheme is now part of the Standard Model of Particle Physics

- However, the CP violation of the KM mechanism is too small to account for the asymmetry between matter and anti-matter in the Universe (falls short by 10 orders of magnitude !)
- SM does not contain the fourth fundamental interaction, gravitation
- Most of the Universe is made of stuff we do not understand...

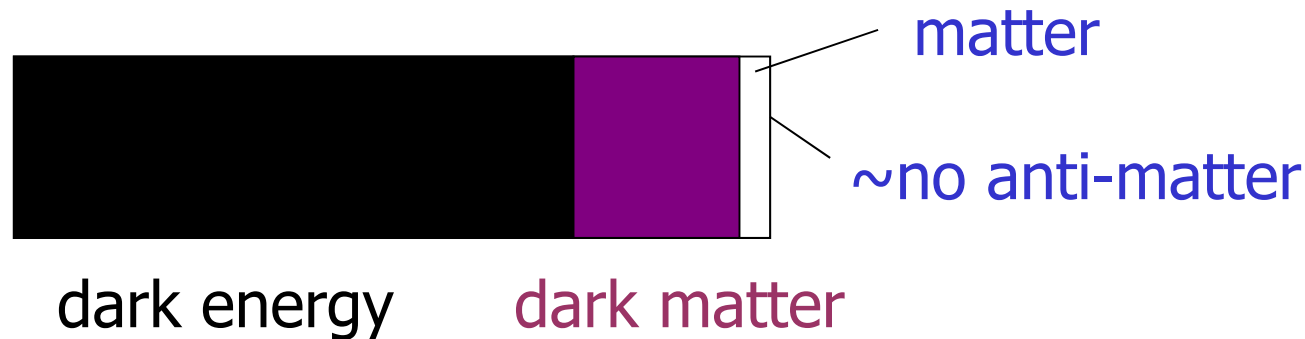

Are we done ? (Didn't the B factories accomplish their mission, recognized by the 2008 Nobel Prize in Physics ?)



Из эссе С. Окубо
при большой температуре
для Вселенной сила слабо
но ее кривой фигуре

НАРУШЕНИЕ CP-ИНВАРИАНТНОСТИ, C-АСИММЕТРИЯ
И БАРИОННАЯ АСИММЕТРИЯ ВСЕЛЕННОЙ

А.Д. Сахаров

Теория расширяющейся Вселенной, предполагающая сверхплотное начальное состояние вещества, по-видимому, исключает возможность макроскопического разделения вещества и антивещества; поэтому следует

Matter - anti-matter
asymmetry of the Universe:
KM (Kobayashi-Maskawa)
mechanism still short by 10
orders of magnitude !!!

Two frontiers

Two complementary approaches to study shortcomings of the Standard Model and to search for the so far unobserved processes and particles (so called New Physics, NP). These are the **energy frontier** and the **intensity frontier** .

Energy frontier : direct search for production of unknown particles at the highest achievable energies.

Intensity frontier : search for rare processes, deviations between theory predictions and experiments with the ultimate precision.

→ for this kind of studies, one has to investigate a very large number of reactions events → need accelerators with ultimate **intensity** (= luminosity)

Comparison of **energy /intensity** frontiers

To observe a large ship far away one can either use **strong binoculars** or observe **carefully the direction and the speed of waves** produced by the vessel.

Energy frontier (LHC)

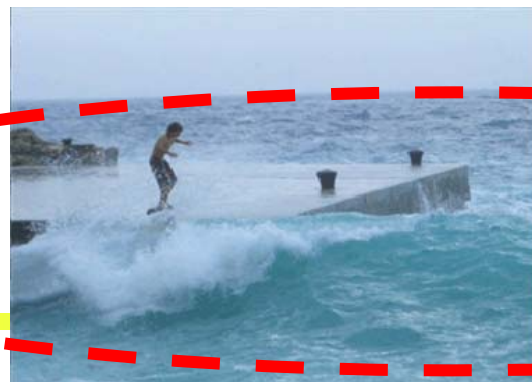
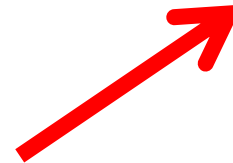

**Luminosity frontier
(Belle and Belle II)**

An example: Hunting the **charged Higgs** in the decay $B^- \rightarrow \tau^- \nu_\tau$

In addition to the Standard Model Higgs – most probably just discovered at the LHC - in New Physics (e.g., in supersymmetric theories) there could also be a **charged Higgs**.

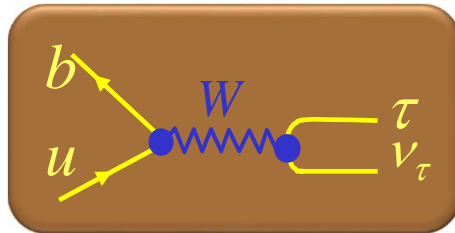

The rare decay $B^- \rightarrow \tau^- \nu_\tau$ is in SM mediated by the **W** boson

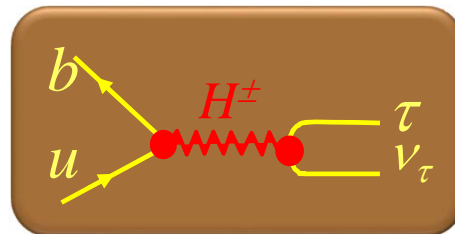

In some supersymmetric extensions it can also proceed via a **charged Higgs**

The **charged Higgs** would influence the decay of a B meson to a tau lepton and its neutrino, and modify the probability for this decay.

Missing Energy Decays: $B^- \rightarrow \tau^- \nu_\tau$

$$B^+ \rightarrow D^0 \pi^+ \\ (\rightarrow K \pi^- \pi^+ \pi^-) \\ B^- \rightarrow \tau (\rightarrow e \nu \bar{\nu}) \nu$$

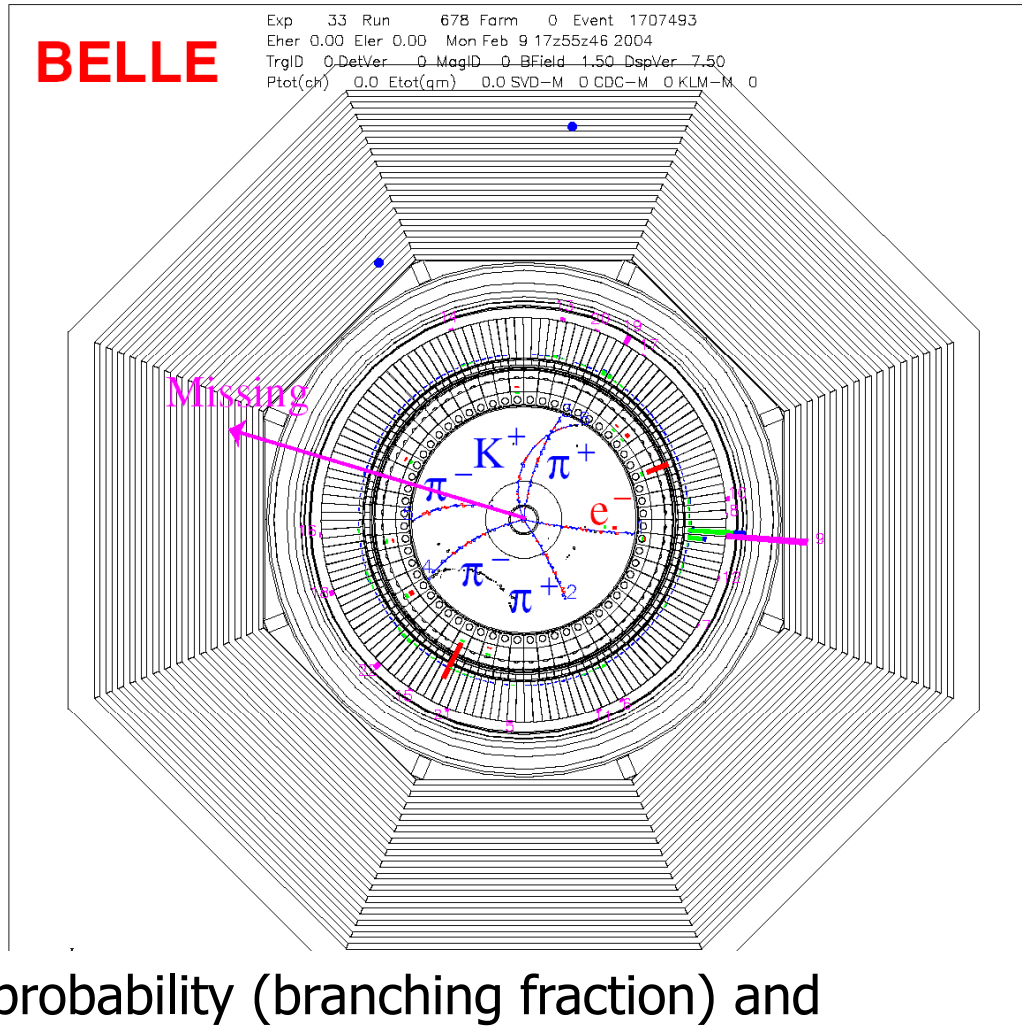

By measuring the decay probability (branching fraction) and comparing it to the SM expectation:

→ Properties of the charged Higgs (e.g. its mass)

Charged Higgs limits from $B \rightarrow \tau^- \nu_\tau$

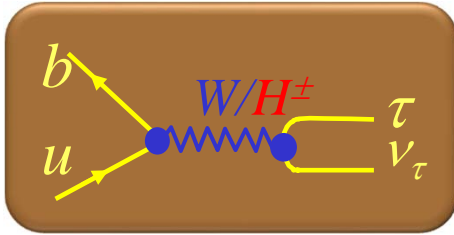

$$r_H = \frac{BF(B \rightarrow \tau \nu)}{BF(B \rightarrow \tau \nu)_{SM}} = \left(1 - \frac{m_B^2}{m_H^2} \tan^2 \beta \right)^2$$

Measured value

→ limit on charged Higgs mass vs. $\tan\beta$
(for type II 2HDM)

B factories: Exclusion plot

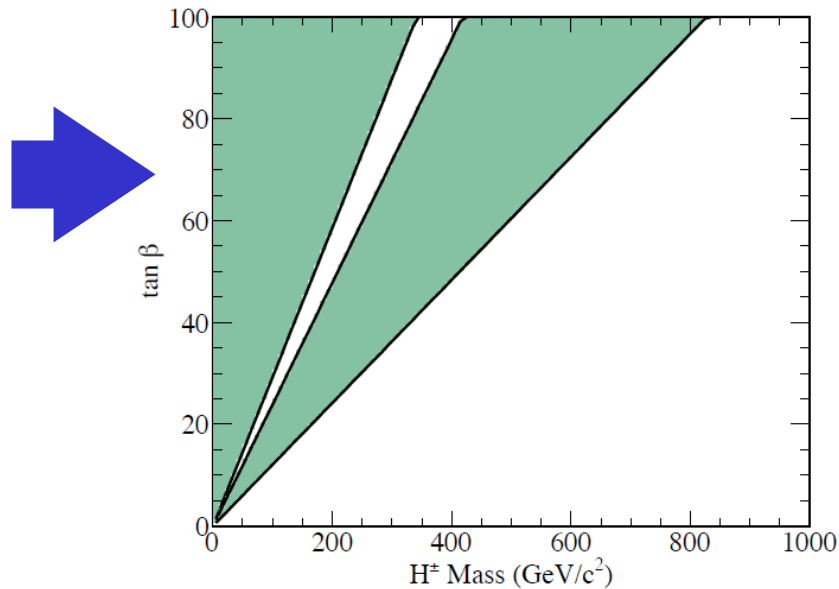

Super B factory: Discovery plot: very much competitive with LHC!

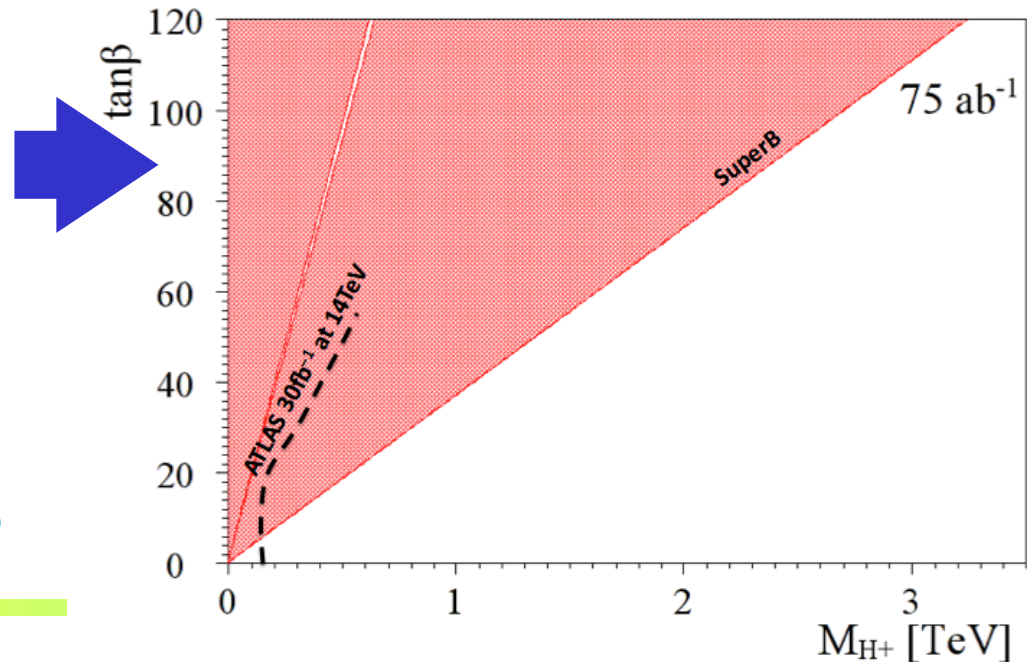

New Physics reach

energy frontier vs. intensity frontier

NP mass scale
(TeV)

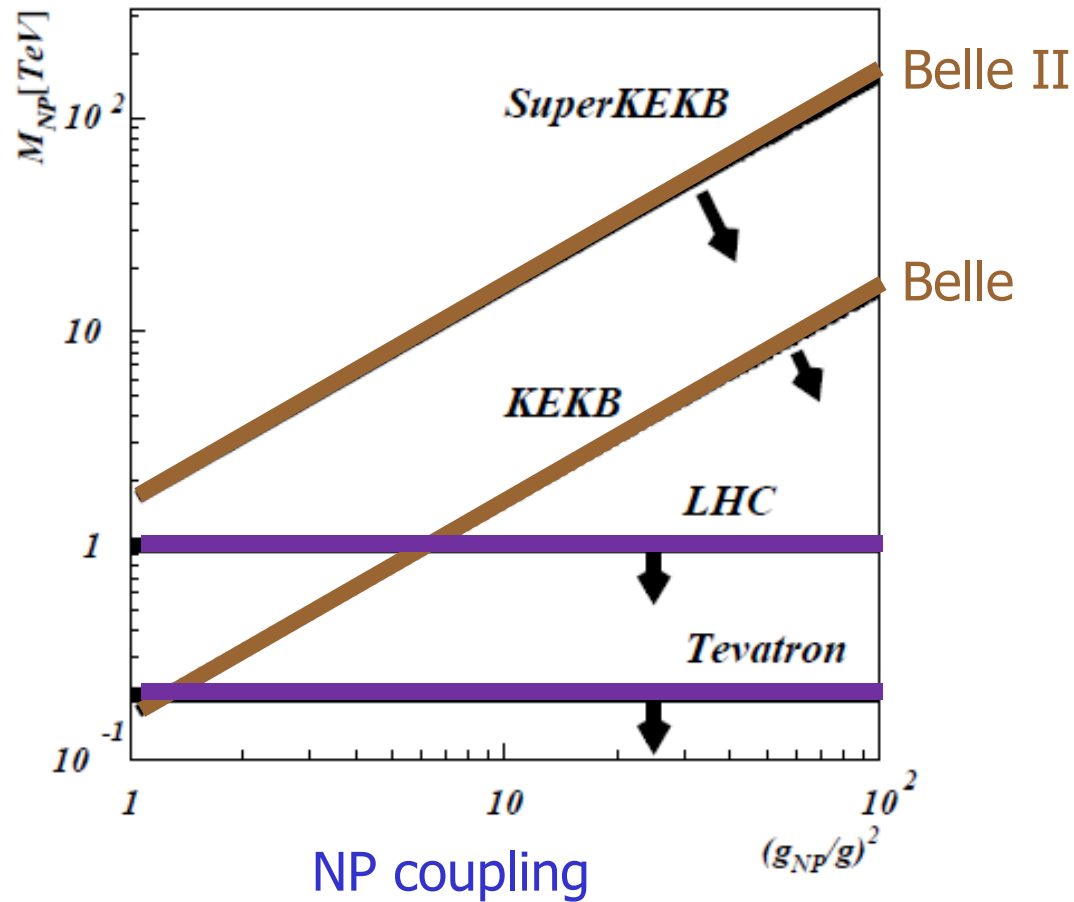

Super B Factory Motivation 2

- Lessons from history: the top quark

Physics of top quark

First estimate of mass: BB mixing → ARGUS
Direct production, Mass, width etc. → CDF/D0
Off-diagonal couplings, phase → BaBar/Belle

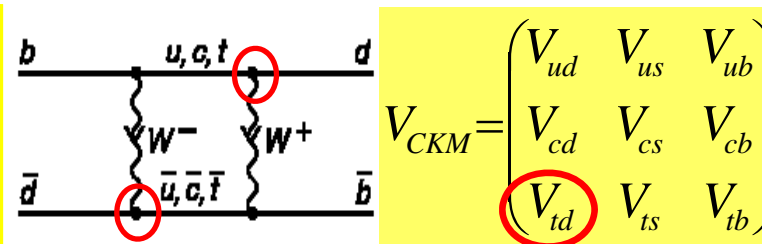

- Even before that: prediction of charm quark from the GIM mechanism, and its mass from K^0 mixing

Integrated luminosity at B factories

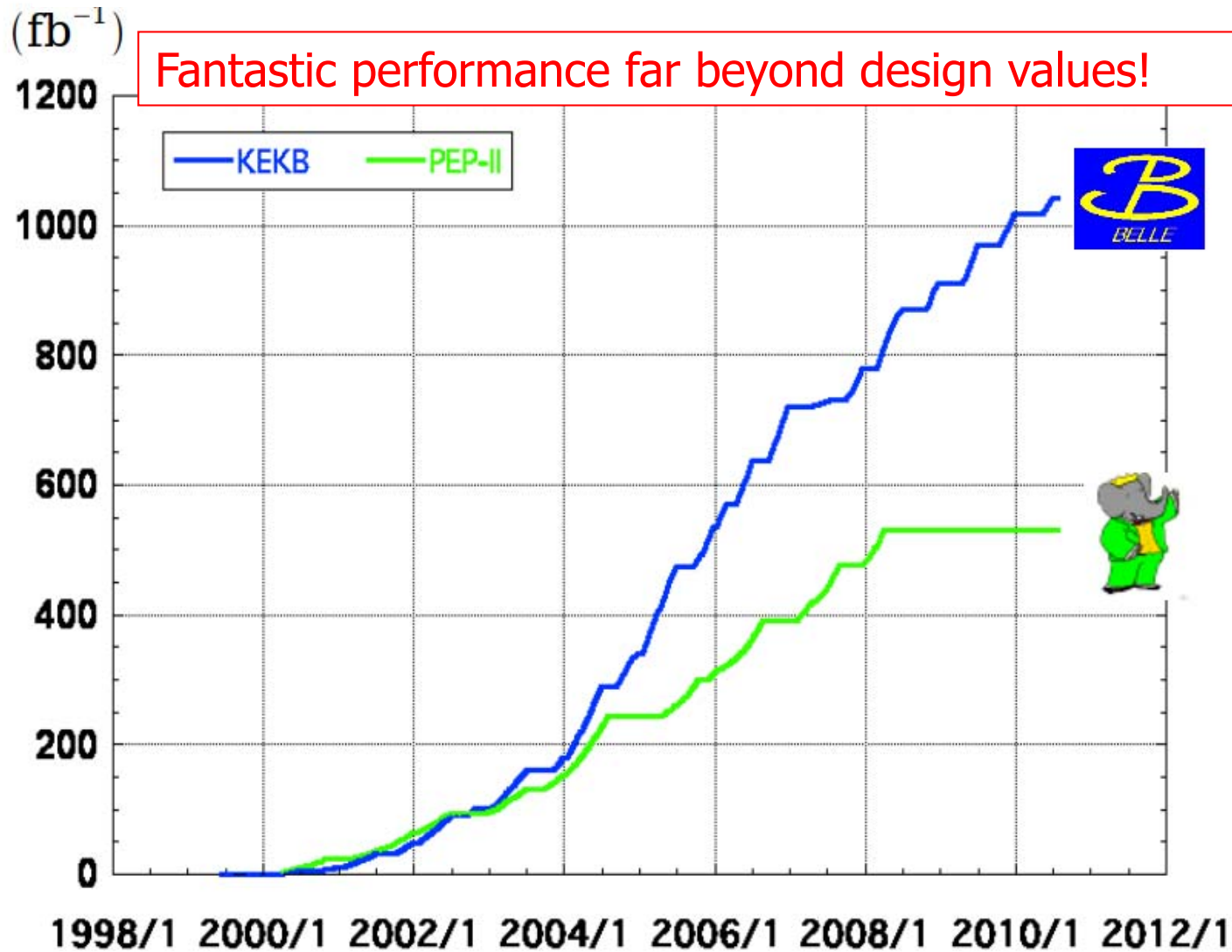

> 1 ab^{-1}

On resonance:

$Y(5S)$: 121 fb^{-1}

$Y(4S)$: 711 fb^{-1}

$Y(3S)$: 3 fb^{-1}

$Y(2S)$: 25 fb^{-1}

$Y(1S)$: 6 fb^{-1}

Off reson./scan:

$\sim 100 \text{ fb}^{-1}$

$\sim 550 \text{ fb}^{-1}$

On resonance:

$Y(4S)$: 433 fb^{-1}

$Y(3S)$: 30 fb^{-1}

$Y(2S)$: 14 fb^{-1}

Off resonance:

$\sim 54 \text{ fb}^{-1}$

What next?

To search for NP effects, need **much more data** (two orders!) →
Luminosity frontier experiment

→ LHCb

→ Super B factory

LHCb: well underway, doing excellent physics

An e^+e^- machine running at (or near) $\Upsilon(4s)$ will have **considerable advantages in several classes of measurements**, and will be **complementary in many more**

Advantages of B factories in the LHC era

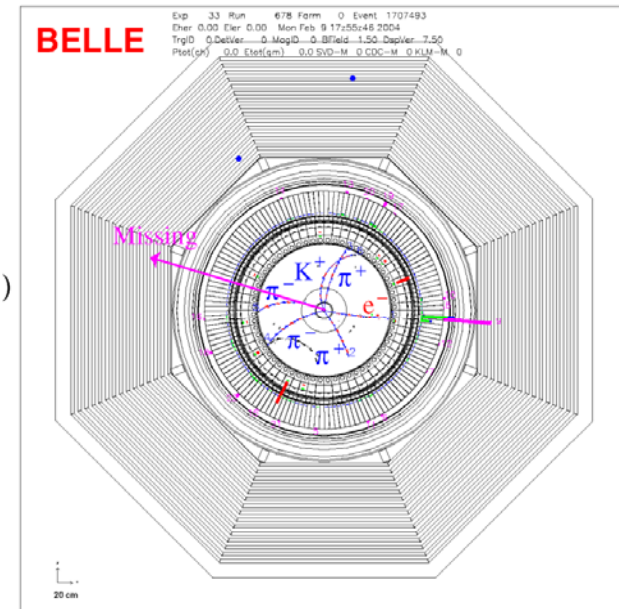
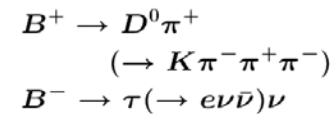

Unique capabilities of B factories:

- Exactly two B mesons produced (at $\Upsilon(4S)$)
- High flavour tagging efficiency
- Detection of gammas, π^0 s, K_L s
- Very clean detector environment (can observe decays with several neutrinos in the final state!)
- Well understood apparatus, with known systematics, checked on control channels

(Super) B factory advantages: Full Reconstruction Method

- Fully reconstruct one of the B's to
 - Tag B flavor/charge
 - Determine B momentum
 - Exclude decay products of one B from further analysis

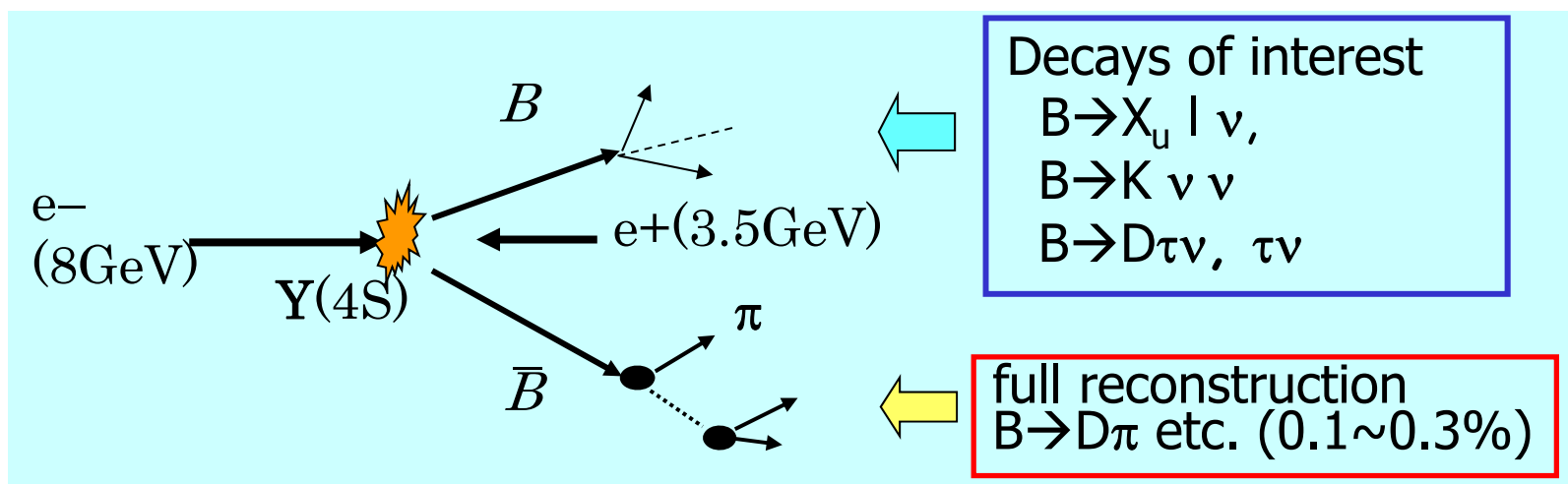

→ Offline B meson beam!

Powerful tool for B decays with neutrinos

Missing Energy Decays: $B^- \rightarrow \tau^- \nu_\tau$

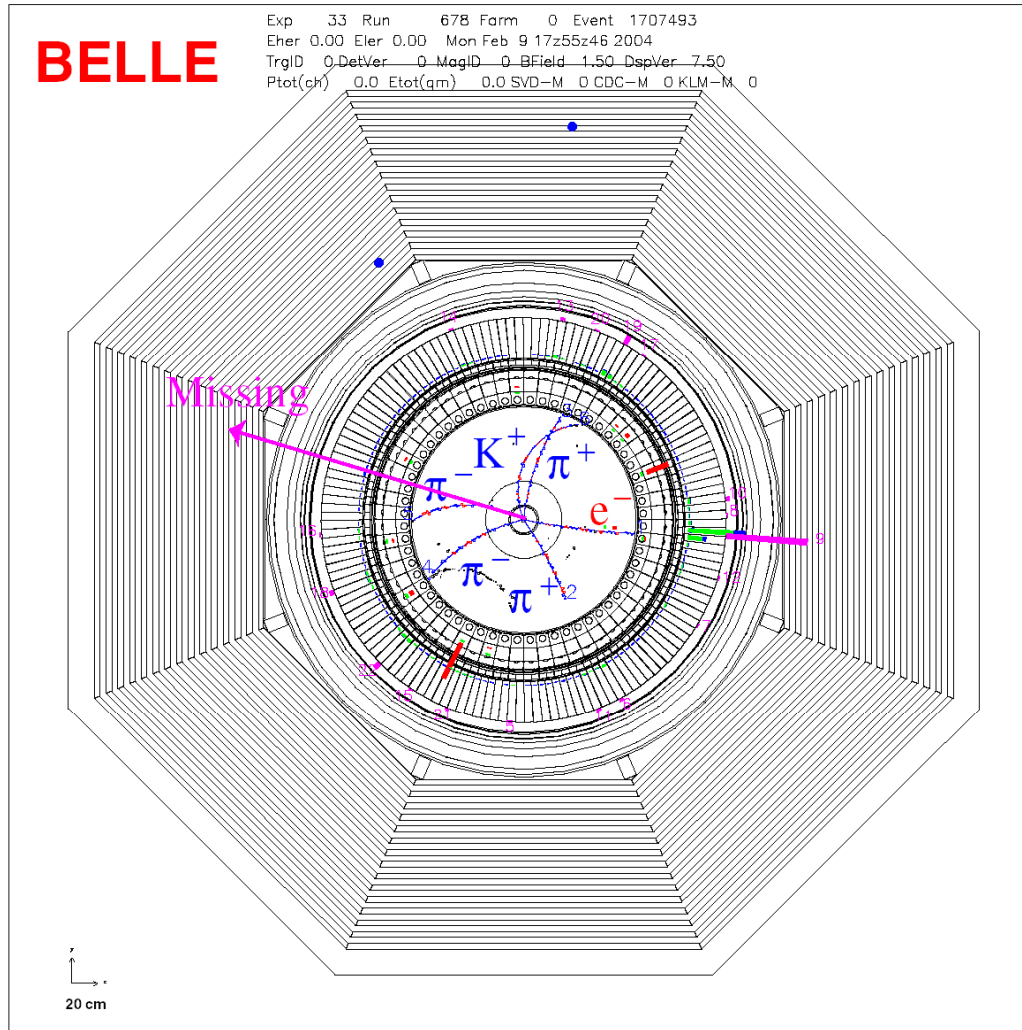
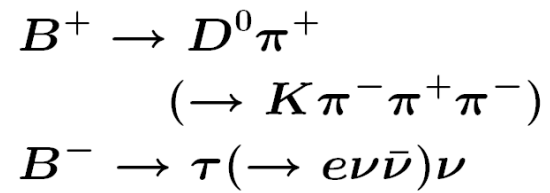

B \rightarrow $\nu \nu$ decay

B \rightarrow $\nu \nu$ similar as B \rightarrow $\mu \mu$ a very sensitive channel to NP contributions

Even more strongly helicity suppressed by $\sim(m_\nu/m_B)^2$

\rightarrow Any signal = NP

Unique feature at B factories: use tagged sample with fully reconstructed B decays on one side, require no signal from the other B.

Use rest energy in the calorimeter and angular distribution as the fit variables.



90% C.L. BR $< 1.3 \times 10^{-4}$
Belle Preliminary 657M BBbar



c.f. (Babar) BR $< 2.2 \times 10^{-4}$

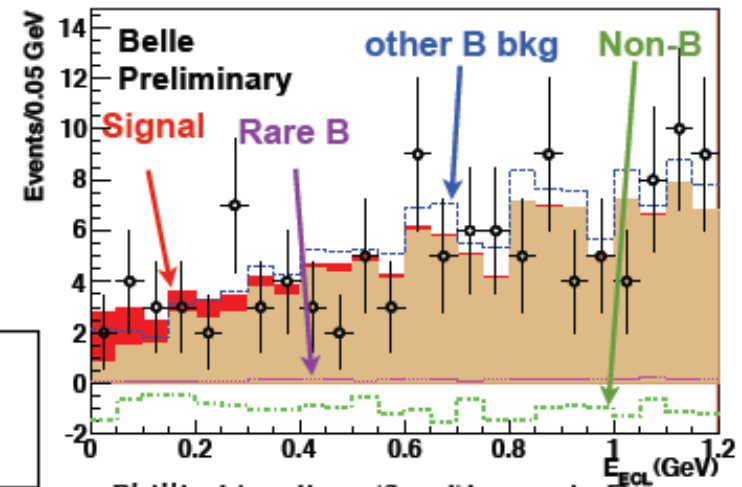

Physics at a Super B Factory

- There is a good chance to see new phenomena;
 - **CPV in B decays from the new physics (non KM).**
 - **Lepton flavor violations in τ decays.**
- They will help to diagnose (if found) or constrain (if not found) new physics models.
- $B \rightarrow \tau \nu$, $D_{\tau \nu}$ can probe the charged Higgs in large $\tan\beta$ region.
- **Physics motivation is independent of LHC.**
 - If LHC finds NP, precision flavour physics is compulsory.
 - If LHC finds no NP, high statistics B/ τ decays would be a unique way to search for the $> \text{TeV}$ scale physics (=TeV scale in case of MFV).

Physics reach with 50 ab^{-1} :

- Physics at Super B Factory (Belle II authors + guests)
hep-ex arXiv:1002.5012

How to do it?
Upgrade KEKB and Belle
→ SuperKEKB and Belle II

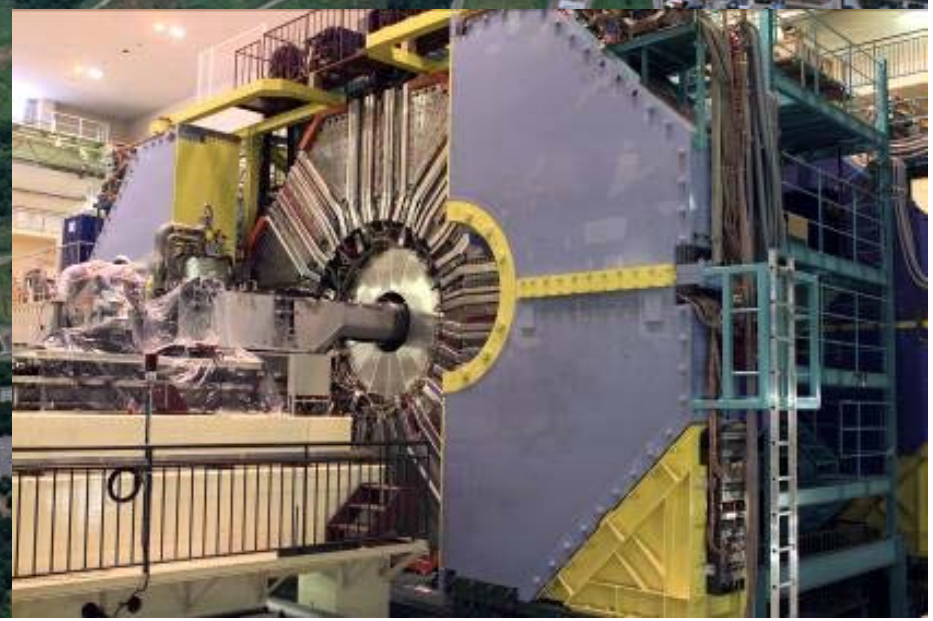
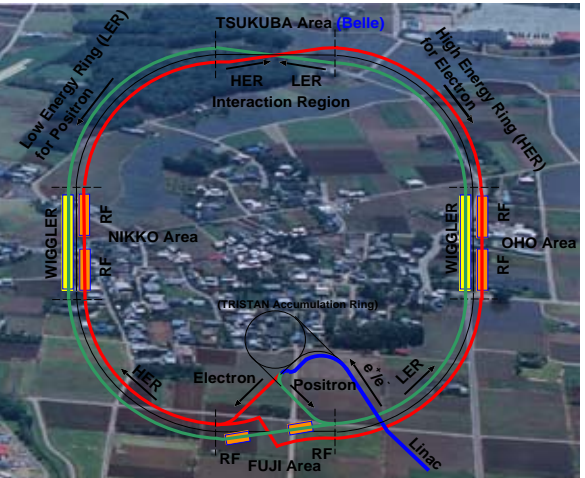

Accelerator

The KEKB Collider

Fantastic performance far beyond design values!

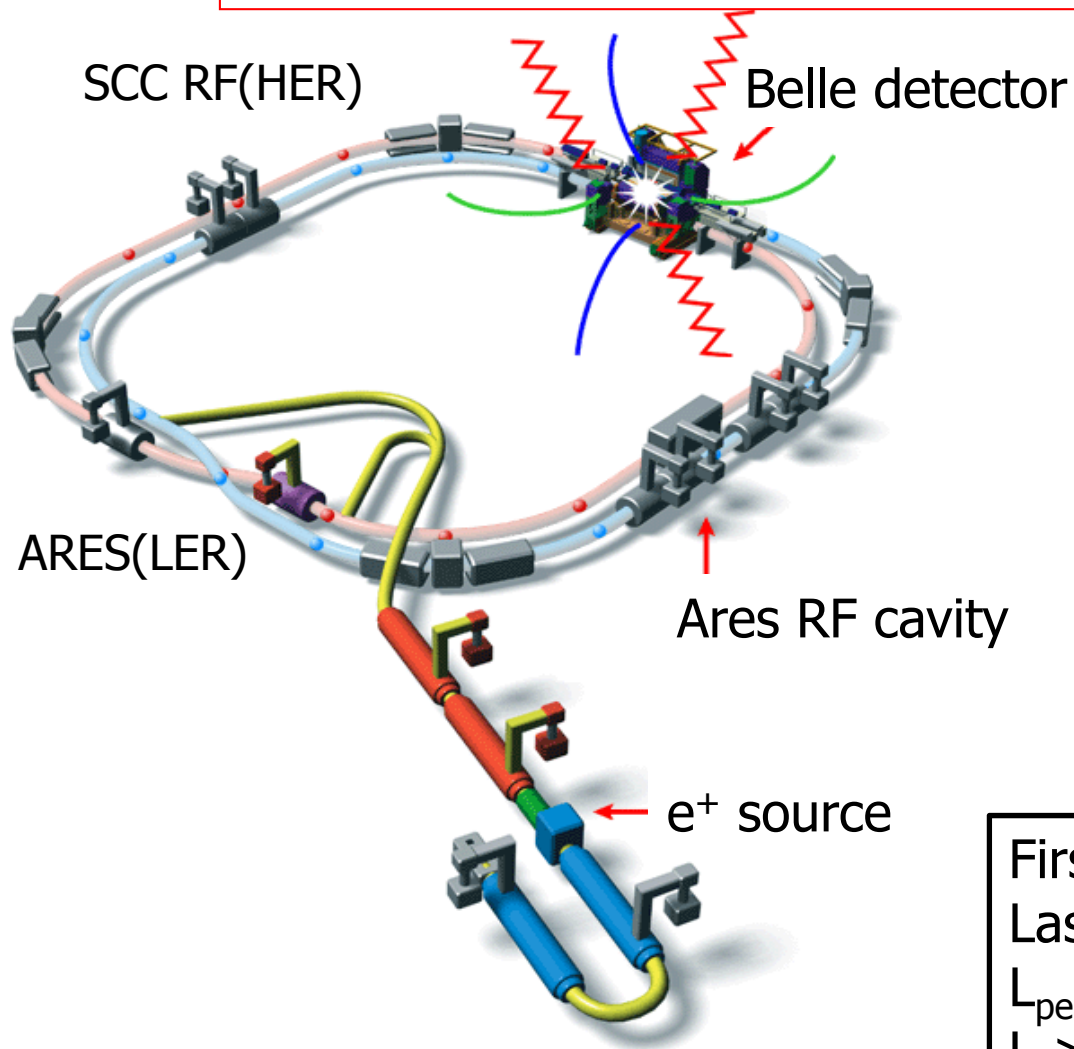

- e⁻ (8 GeV) on e⁺ (3.5 GeV)
 - $\sqrt{s} \approx m_{\Upsilon(4S)}$
 - Lorentz boost: $\beta\gamma=0.425$
- 22 mrad crossing angle

Peak luminosity (WR!) :
 $2.1 \times 10^{34} \text{ cm}^{-2}\text{s}^{-1}$
=2x design value

First physics run on June 2, 1999
Last physics run on June 30, 2010
 $L_{\text{peak}} = 2.1 \times 10^{34} / \text{cm}^2/\text{s}$
 $L > 1 \text{ ab}^{-1}$

SuperKEKB is the intensity frontier

Peak luminosity trends (e^+e^- colliders)

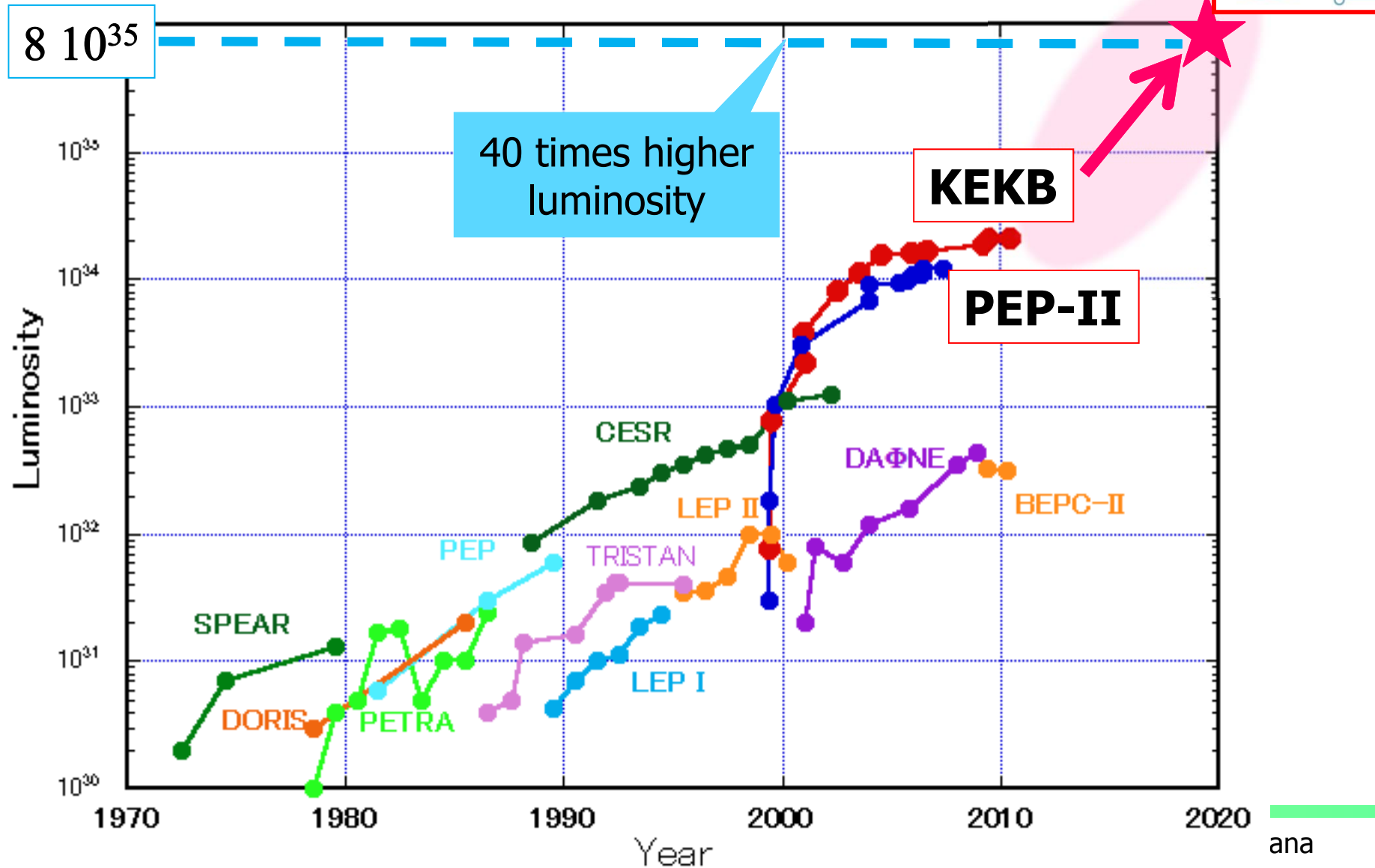

How to increase the luminosity?



$$L = \frac{\gamma_{e^\pm}}{2er_e} \left(1 + \frac{\sigma_y^*}{\sigma_x^*} \right) \left(\frac{I_{e^\pm} \xi_{\Sigma y}^{e^\pm}}{\beta_y^*} \right) \left(\frac{R_L}{R_{\xi_y}} \right)$$

Lorentz factor γ_{e^\pm}
 Beam current I_{e^\pm}
 Beam-beam parameter $\xi_{\Sigma y}^{e^\pm}$
 Classical electron radius r_e
 Beam size ratio@IP $\frac{\sigma_y^*}{\sigma_x^*}$
 Vertical beta function@IP β_y^*
 Lumi. reduction factor (crossing angle) & Tune shift reduction factor (hour glass effect) $\frac{R_L}{R_{\xi_y}}$
 0.8 - 1 (short bunch)

- (1) Smaller β_y^***
 - (2) Increase beam currents**
 - (3) Increase ξ_y
- “Nano-Beam” scheme**

Collision with very small spot-size beams

Invented by Pantaleo Raimondi for SuperB – ‘spin-off’ of linear collider studies

How big is a nano-beam ?



How to go from an excellent accelerator with world record performance – KEKB – to a 40x times better, more intense facility?

In KEKB, colliding electron and positron beams are **much thinner than the human hair...**

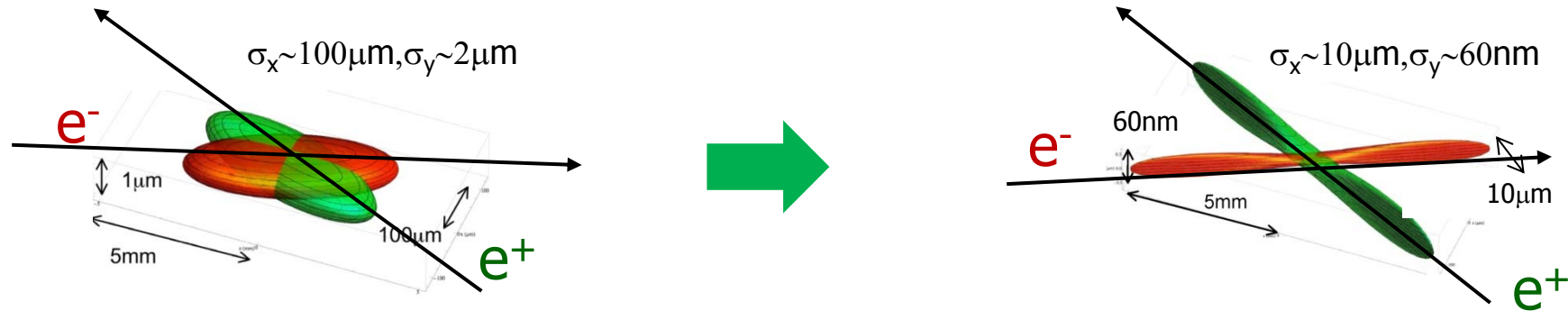

... For a 40x increase in intensity you have to make the beam as thin as a **few 100 atomic layers!**

Machine design parameters



parameters		KEKB		SuperKEKB		units
		LER	HER	LER	HER	
Beam energy	E_b	3.5	8	4	7	GeV
Half crossing angle	φ	11		41.5		mrad
Horizontal emittance	ϵ_x	18	24	3.2	4.6	nm
Emittance ratio	κ	0.88	0.66	0.37	0.40	%
Beta functions at IP	β_x^*/β_y^*	1200/5.9		32/0.27	25/0.30	mm
Beam currents	I_b	1.64	1.19	3.60	2.60	A
beam-beam parameter	ξ_y	0.129	0.090	0.0881	0.0807	
Luminosity	L	2.1×10^{34}		8×10^{35}		$\text{cm}^{-2}\text{s}^{-1}$

- **Nano-beams and a factor of two more beam current** to increase luminosity
- **Large crossing angle**
- **Change beam energies** to solve the problem of short lifetime for the LER

KEKB to SuperKEKB



Colliding bunches

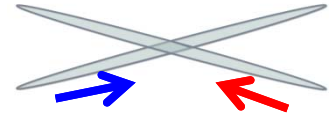

New superconducting / permanent final focusing quads near the IP

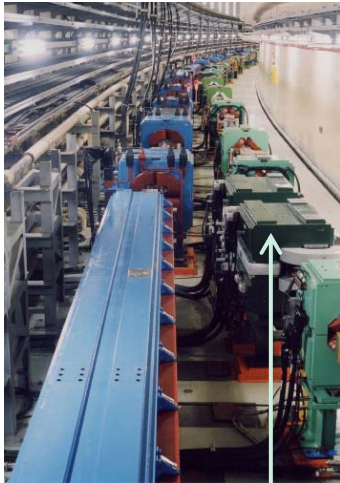
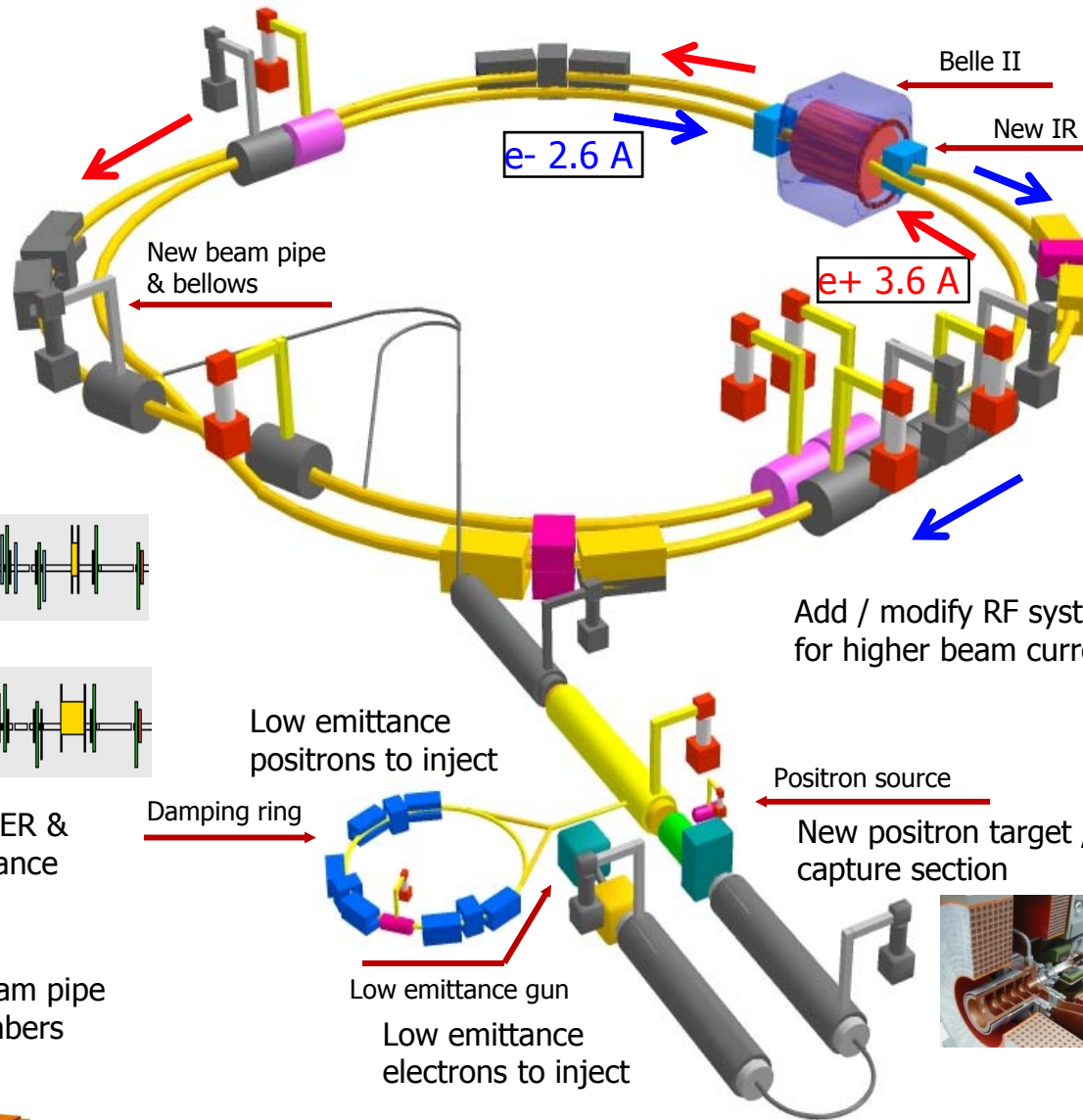

Replace short dipoles with longer ones (LER)

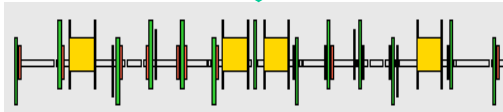
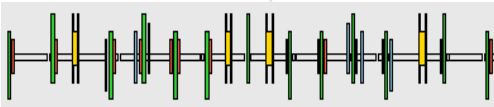

Redesign the lattices of HER & LER to squeeze the emittance

TiN-coated beam pipe with antechambers

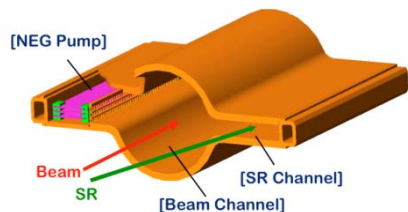

To obtain x40 higher luminosity

Entirely new LER beam pipe with ante-chamber and Ti-N coating



Beam pipe is made of aluminum.



Fabrication of the LER arc beam pipe section is completed

Al ante-chamber before coating

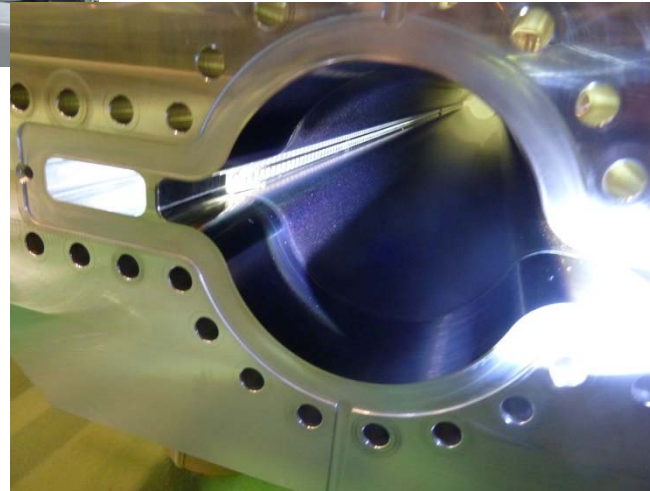
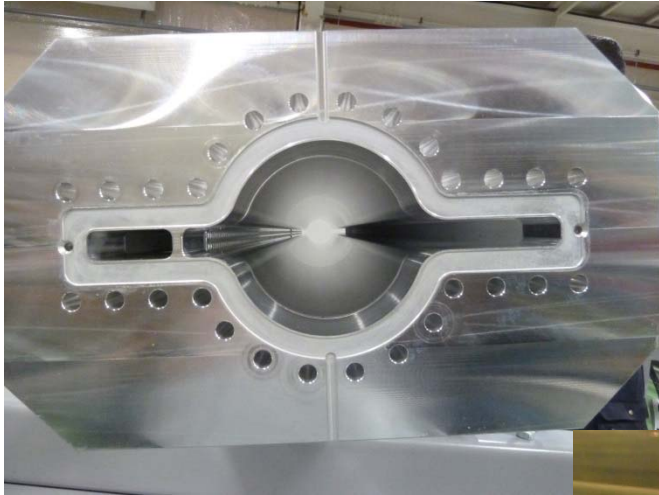

After TiN coating
before baking

After baking





All 100 4 m long dipole magnets have been successfully installed in the low energy ring (LER)!

Three magnets per day !

Installing the 4 m long LER dipole **over** the 6 m long HER dipole (remains in place).

Magnet installation



field measurement

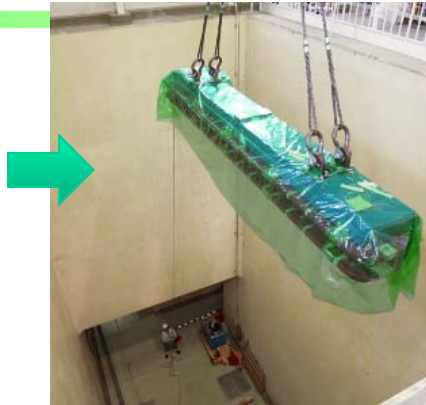

move into tunnel



carry on an air-pallet



carry over existing HER dipole



installation done

Installation of 100 new LER bending magnets done

Experimental apparatus

Typical measurement

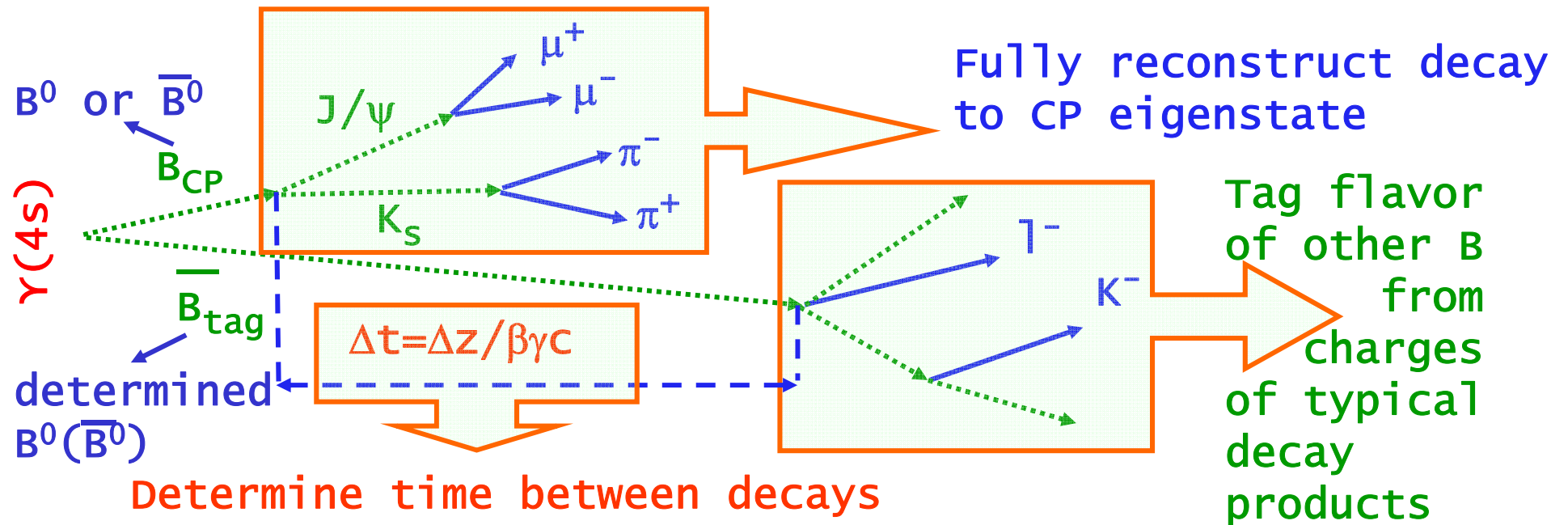

Components of an experimental apparatus ('spectrometer')

- Tracking and vertexing systems
- Particle identification devices
- Calorimeters (measurement of energy)

How to understand what happened in a collision?

Illustration on an example recorded with the Belle detector:

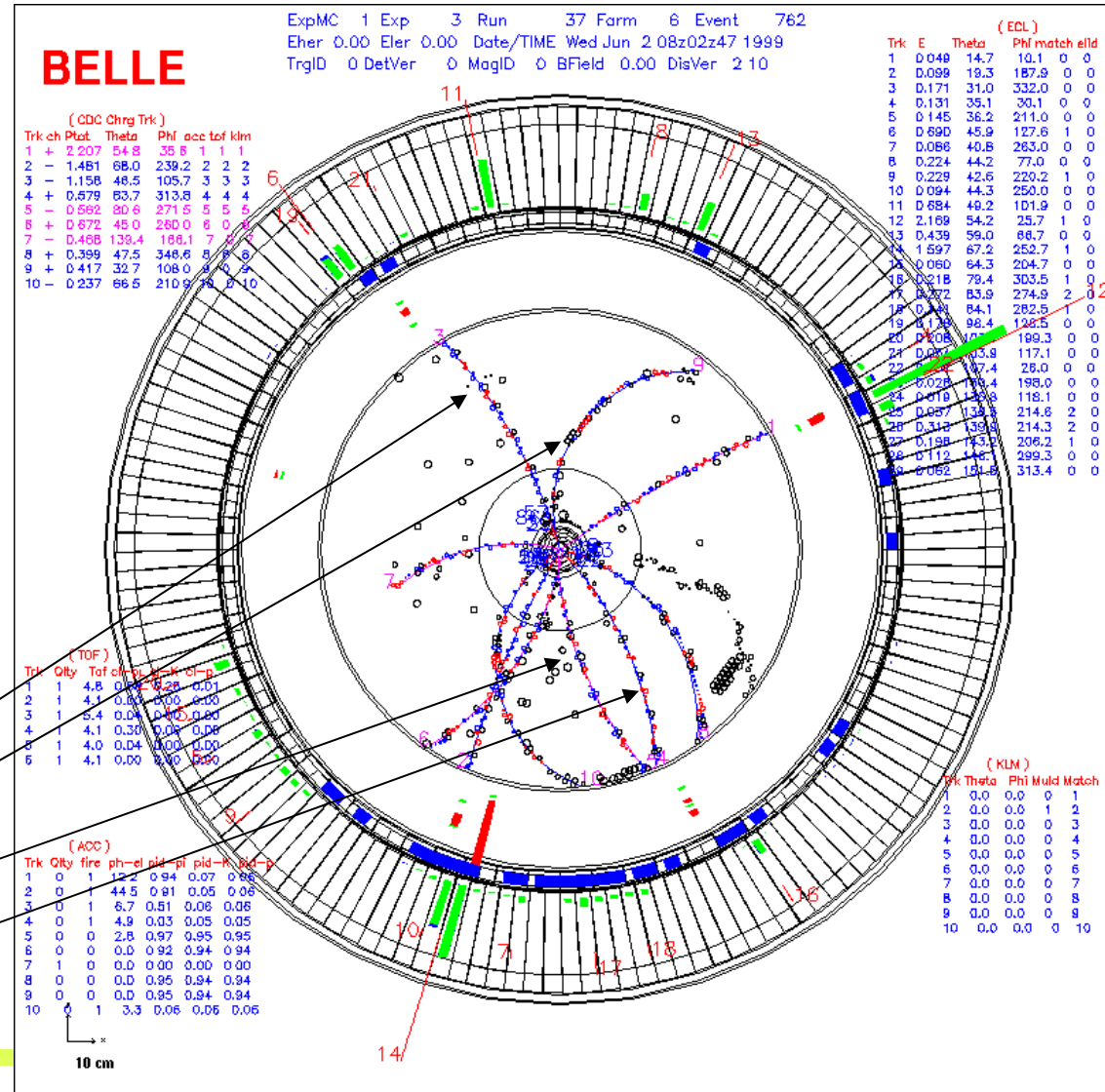
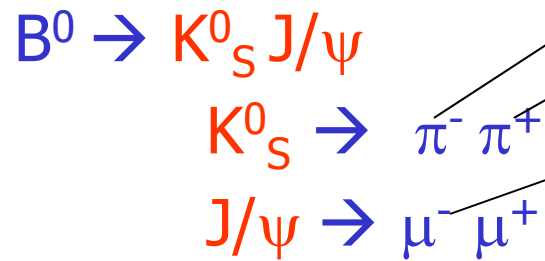



Belle II: Need to build a new detector to handle higher backgrounds

Critical issues at $L = 8 \times 10^{35} / \text{cm}^2 / \text{sec}$

- ▶ **Higher background ($\times 10\text{-}20$)**
 - radiation damage and occupancy
 - fake hits and pile-up noise in the EM
- ▶ **Higher event rate ($\times 10$)**
 - higher rate trigger, DAQ and computing
- ▶ **Require special features**
 - low $p \mu$ identification $\leftarrow s \mu \mu$ recon. eff.
 - hermeticity $\leftarrow \nu$ "reconstruction"

Have to employ and develop new technologies to make such an apparatus work!

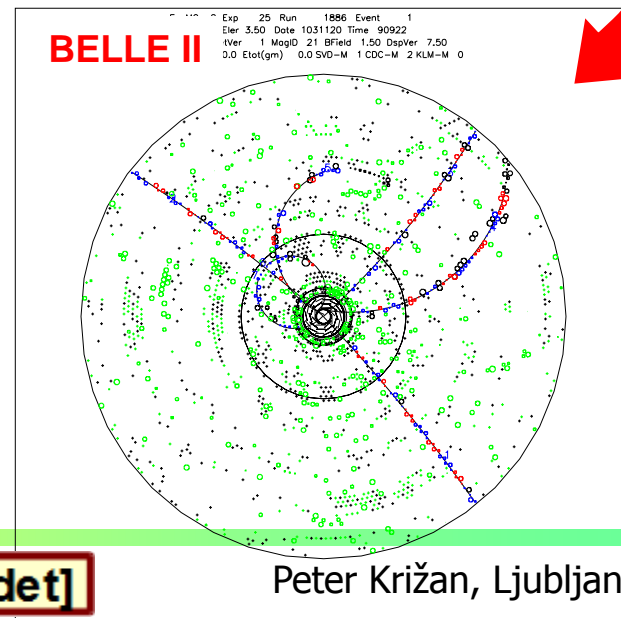
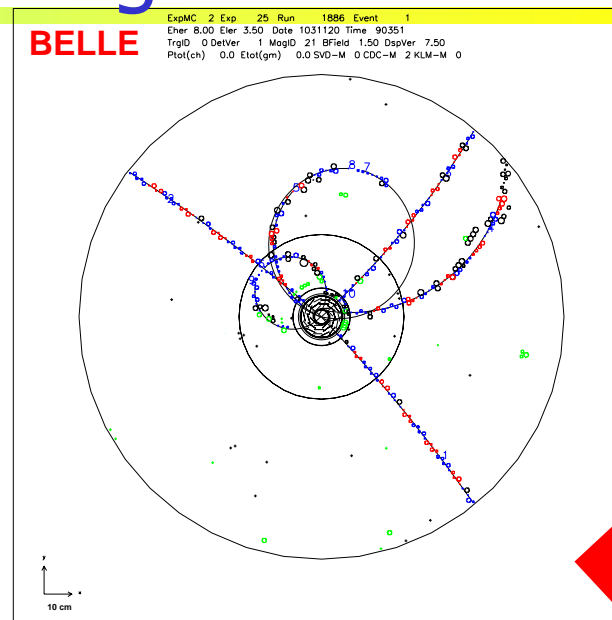

TDR published [arXiv:1011.0352v1](https://arxiv.org/abs/1011.0352v1) [physics.ins-det]

Peter Križan, Ljubljana

Belle II Detector

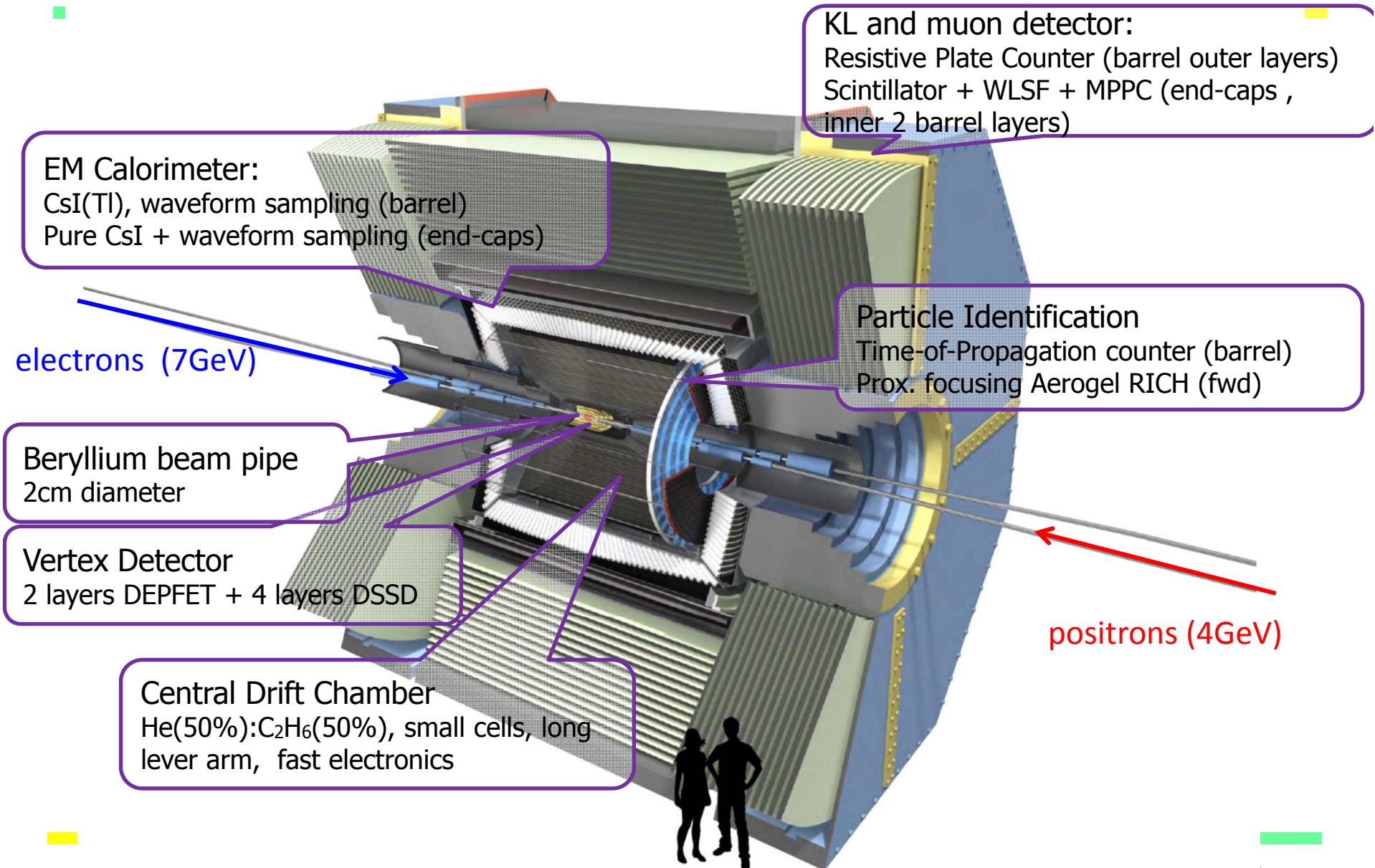

Belle II Detector (in comparison with Belle)

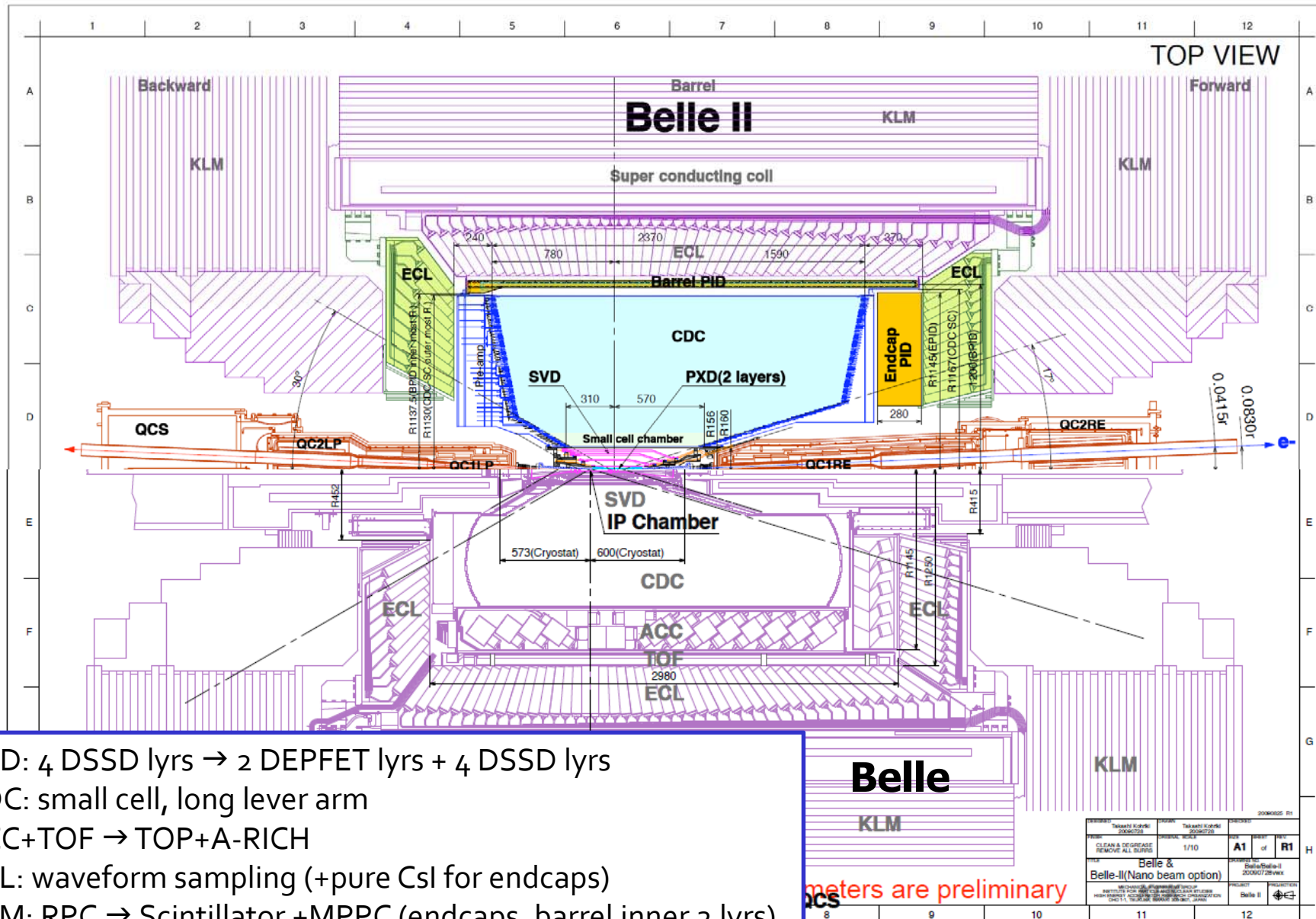

SVD: 4 DSSD lyrs → 2 DEPFET lyrs + 4 DSSD lyrs
 CDC: small cell, long lever arm
 ACC+TOF → TOP+A-RICH
 ECL: waveform sampling (+pure CsI for endcaps)
 KLM: RPC → Scintillator +MPPC (endcaps, barrel inner 2 lyrs)

dimensions are preliminary

CLEAN & DISINFECT REMOVE ALL SURFS	1/10	A1	of R1
Belle & Belle-II(Nano beam option)			
PROJECT: Belle II			

Tracking and vertex systems in Belle II

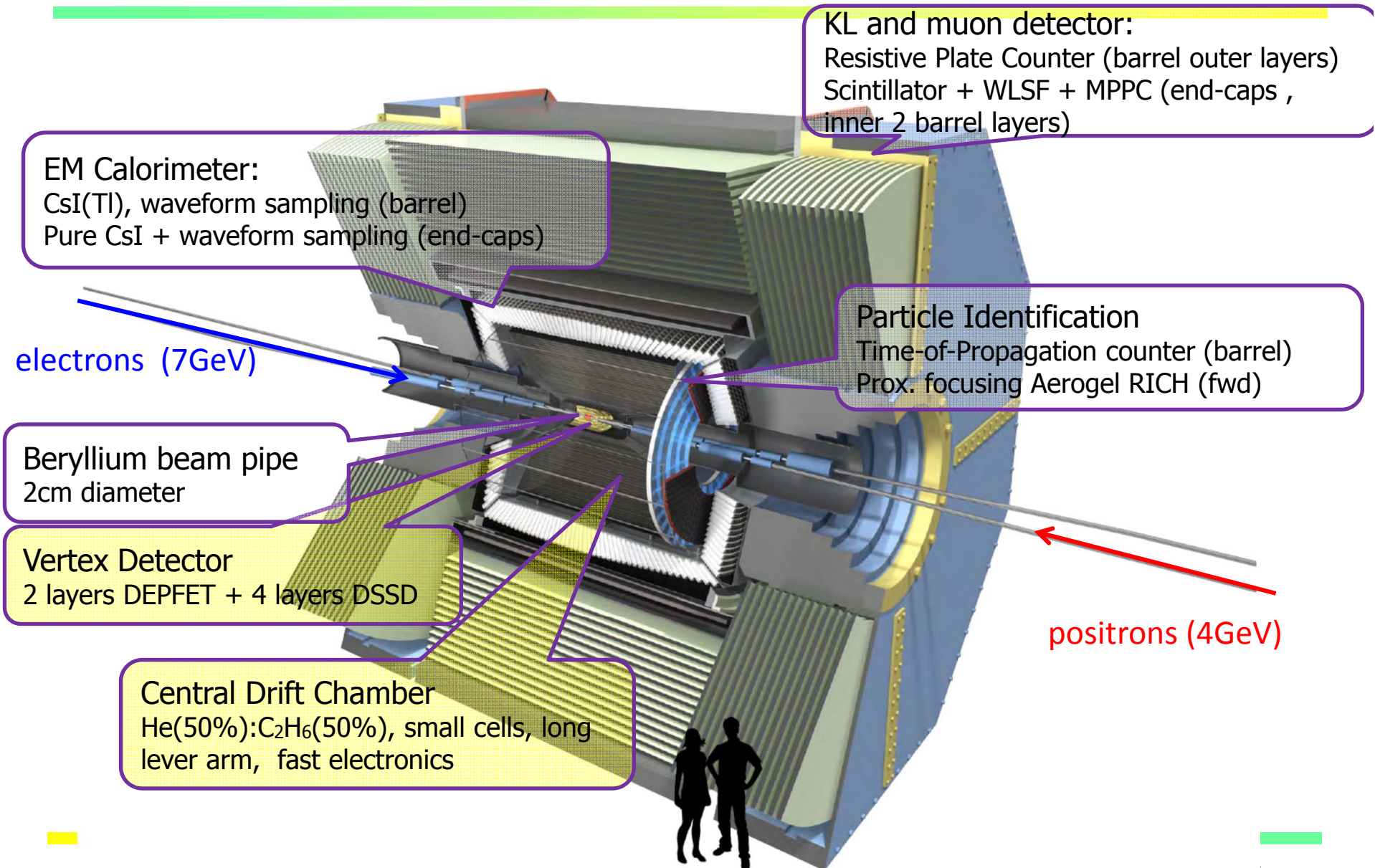

Belle II Detector – vertex region

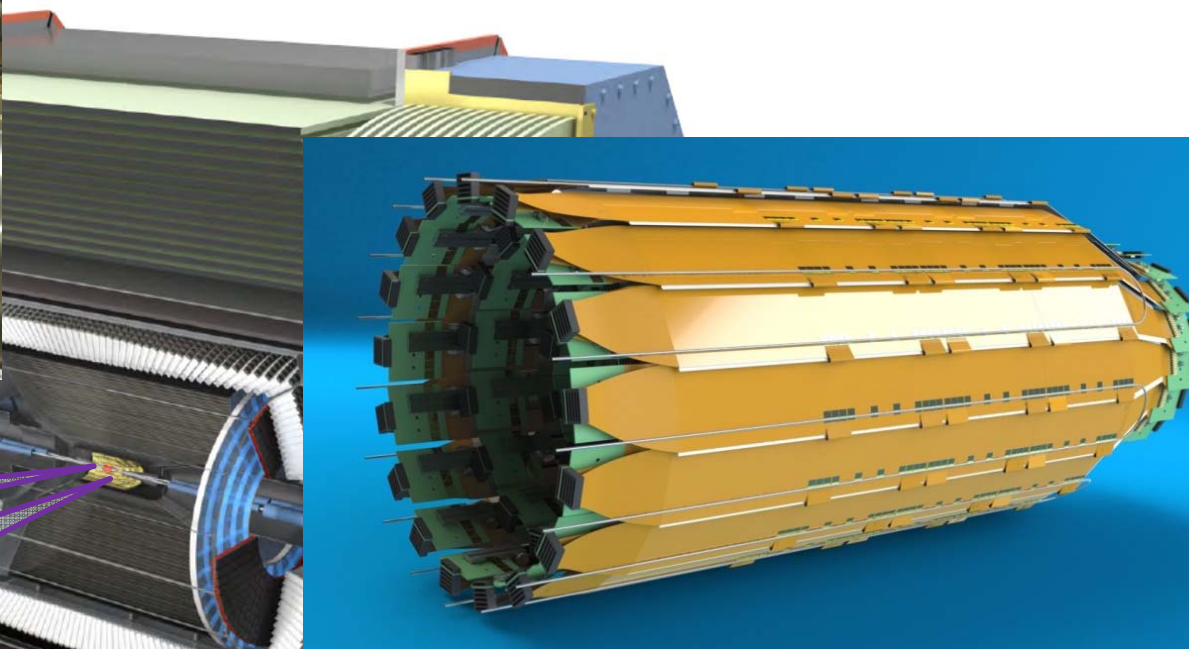

Beryllium beam pipe
2cm diameter

Vertex Detector
2 layers DEPFET + 4 layers DSSD

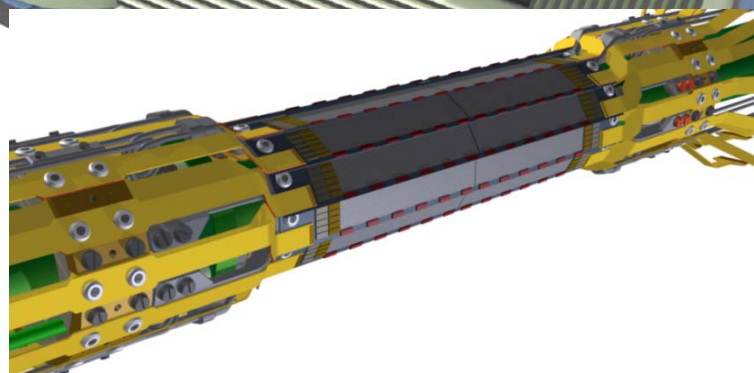

Silicon vertex detector (SVD)

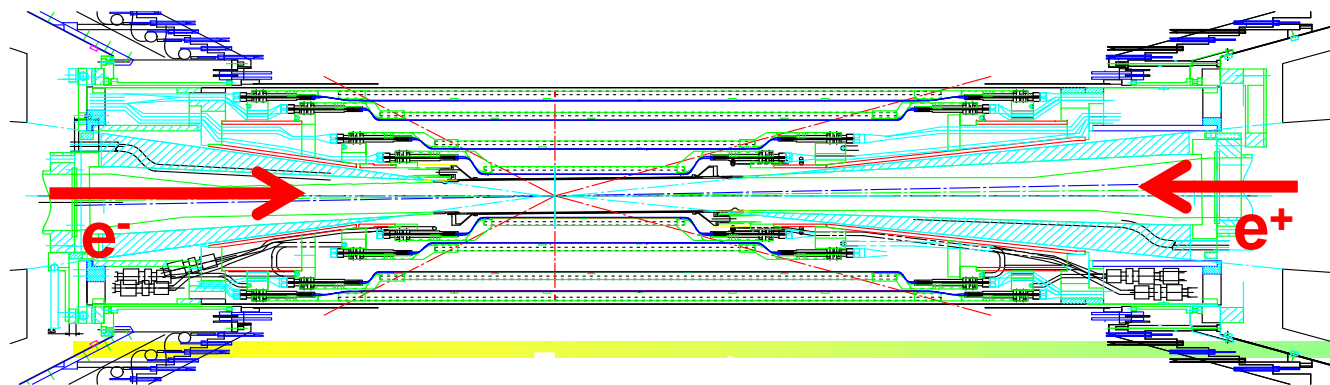
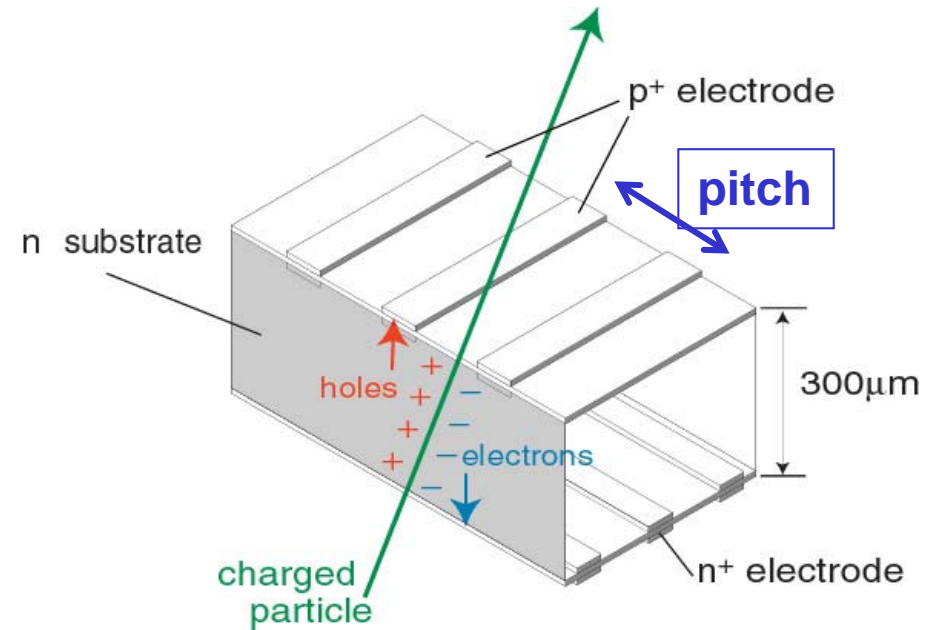
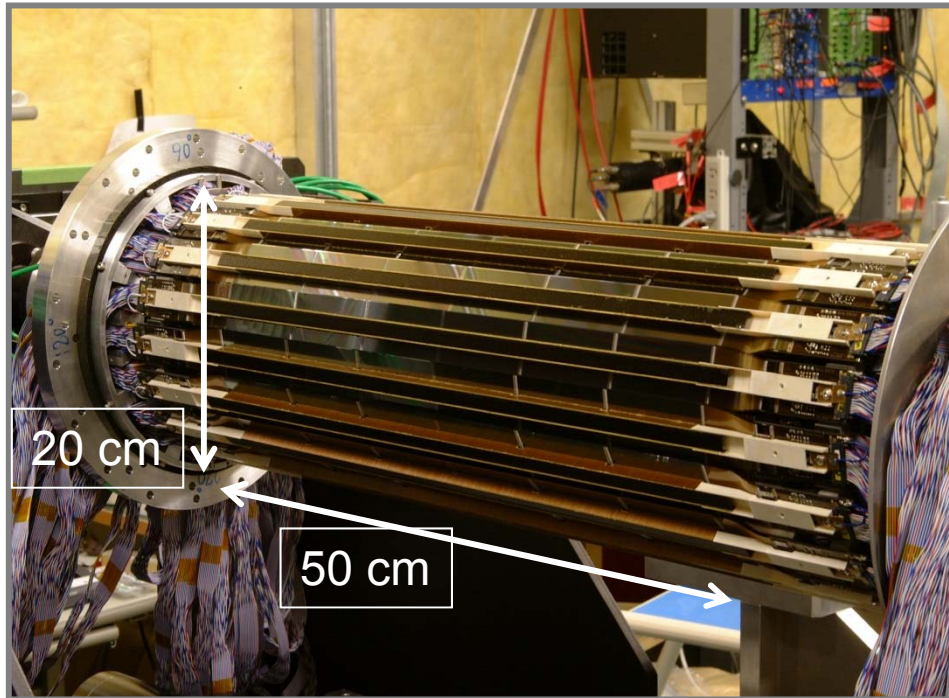

Two coordinates measured at the same time;
strip pitch: $50\mu\text{m}$ ($75\mu\text{m}$);
resolution $15\mu\text{m}$ ($20\mu\text{m}$).

→ Silicon detectors,
Ninković, Tuesday

Belle II Vertex detector SVD+PXD

- Sensors of the innermost layers:
Normal double sided Si detector (DSSD) → DEPFET Pixel sensors
- Configuration: 4 layers → 6 layers (outer radius = 8cm → 14cm)
 - More robust tracking
 - Higher Ks vertex reconstruction efficiency
- Inner radius: 1.5cm → 1.3cm
 - Better vertex resolution
- Strip Readout chip: VA1TA → APV25
 - Reduction of occupancy coming from beam background.
 - Pipeline readout to reduce dead time.

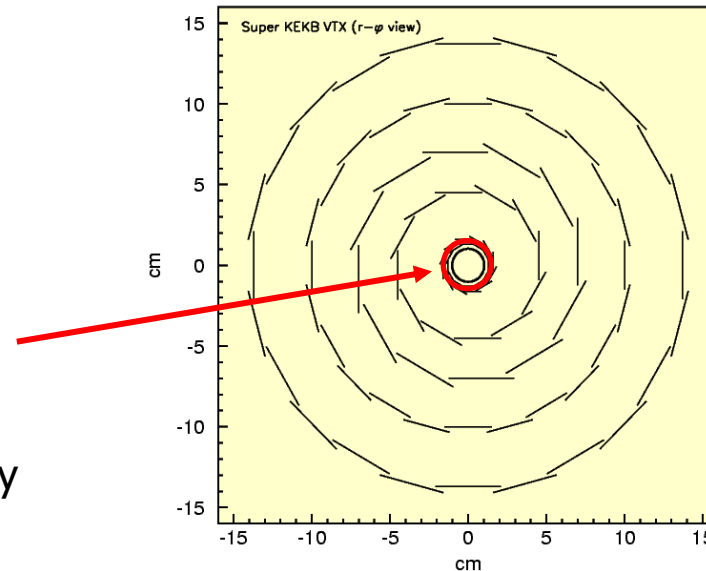

Slant layer to keep the acceptance

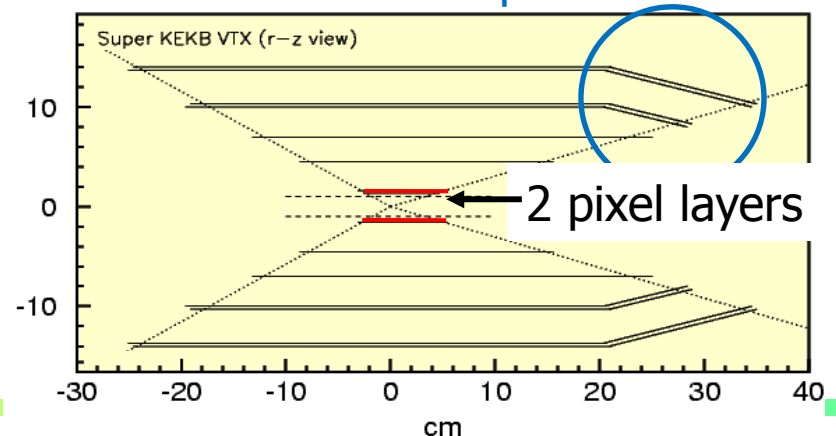

Pixel vertex detector PXD principle: DEPFET

p-channel FET on a completely depleted bulk

A deep n-implant creates a potential minimum for electrons under the gate ("internal gate")

Signal electrons accumulate in the internal gate and modulate the transistor current ($g_q \sim 400 \text{ pA/e}^-$)

Accumulated charge can be removed by a clear contact ("reset")

Invented in MPI Munich

Fully depleted:

→ large signal, fast signal collection

Low capacitance, internal amplification → low noise

Depleted p-channel FET

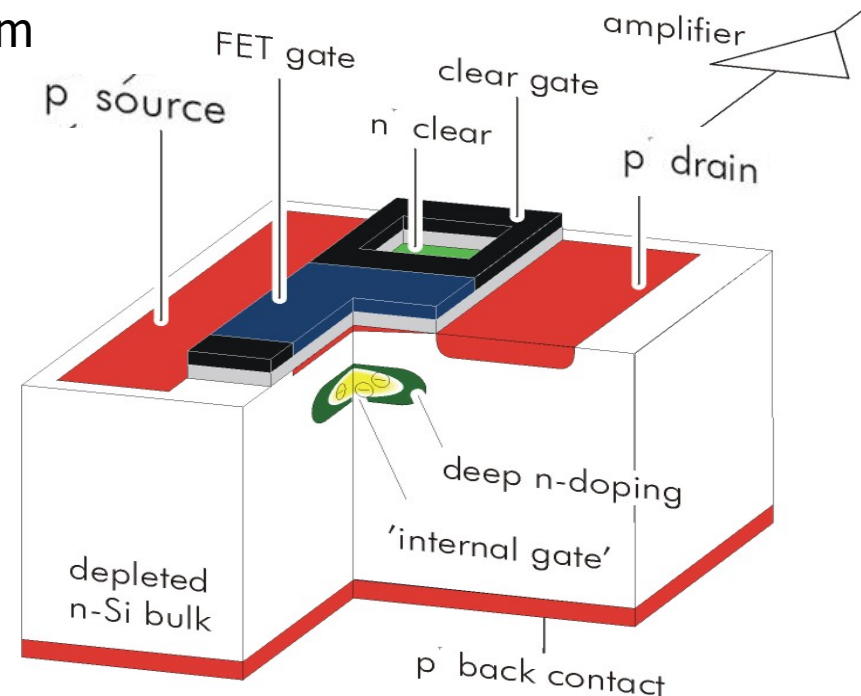

Transistor on only during readout:
low power

Complete clear → no reset noise

Vertex Detector

DEPFET:
<http://aldebaran.hll.mpg.de/twiki/bin/view/DEPFET/WebHome>

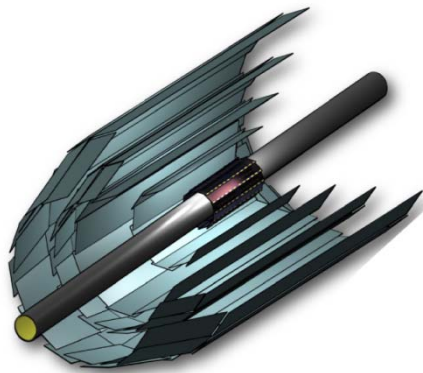

Beam Pipe		r = 10mm
DEPFET	Layer 1	r = 14mm
	Layer 2	r = 22mm
DSSD	Layer 3	r = 38mm
	Layer 4	r = 80mm
	Layer 5	r = 115mm
	Layer 6	r = 140mm

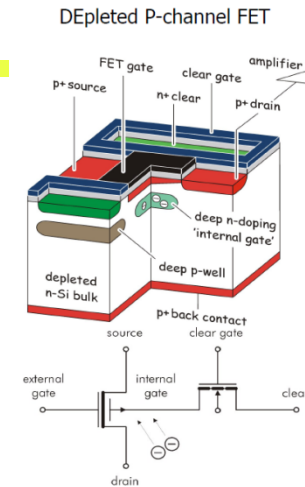

Mechanical mockup of pixel detector



DEPFET pixel sensor

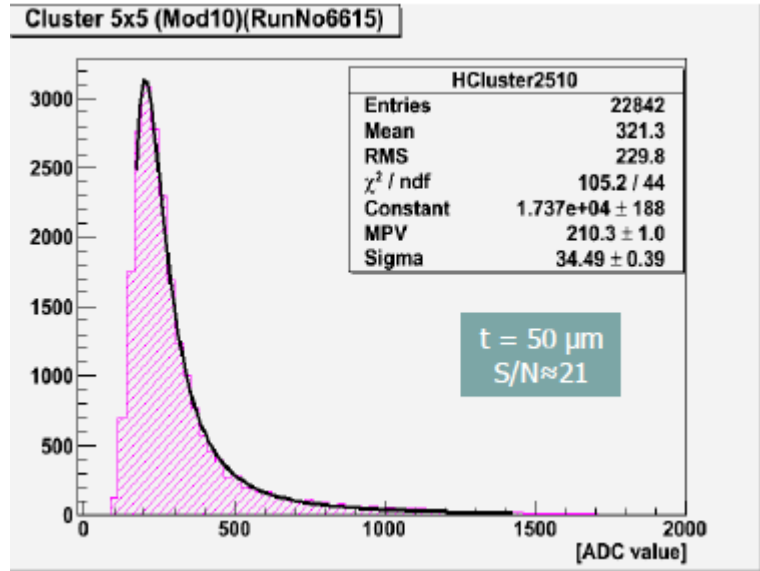

DEPFET sensor: very good S/N

Expected performance

$$\sigma = a + \frac{b}{p\beta \sin^v \theta}$$

Significant improvement in vertex resolution!

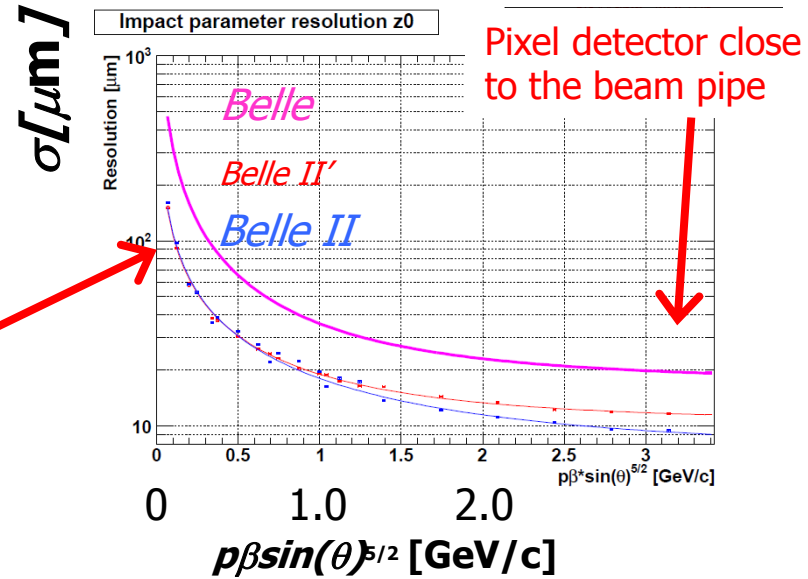

Significant improvement in $\delta S(K_S \pi^0 \gamma)$

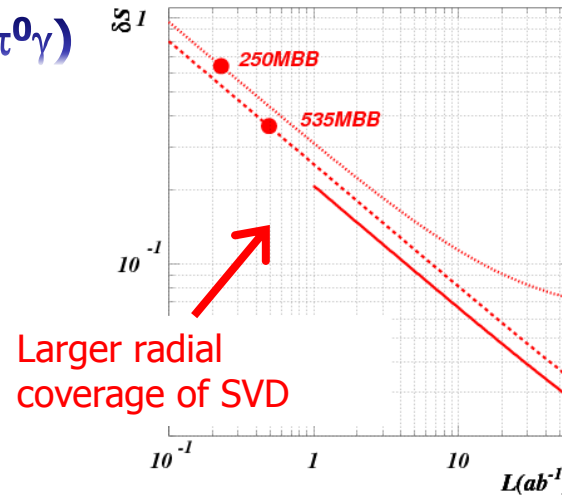
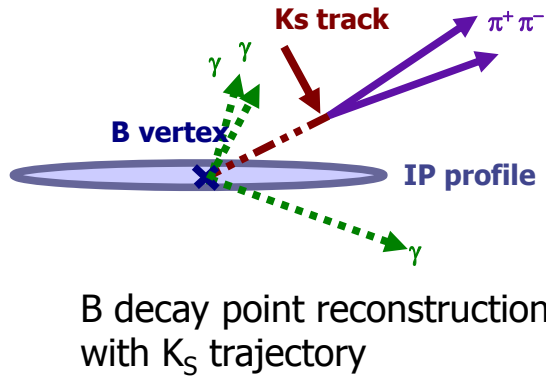

Main tracking device: small cell drift chamber

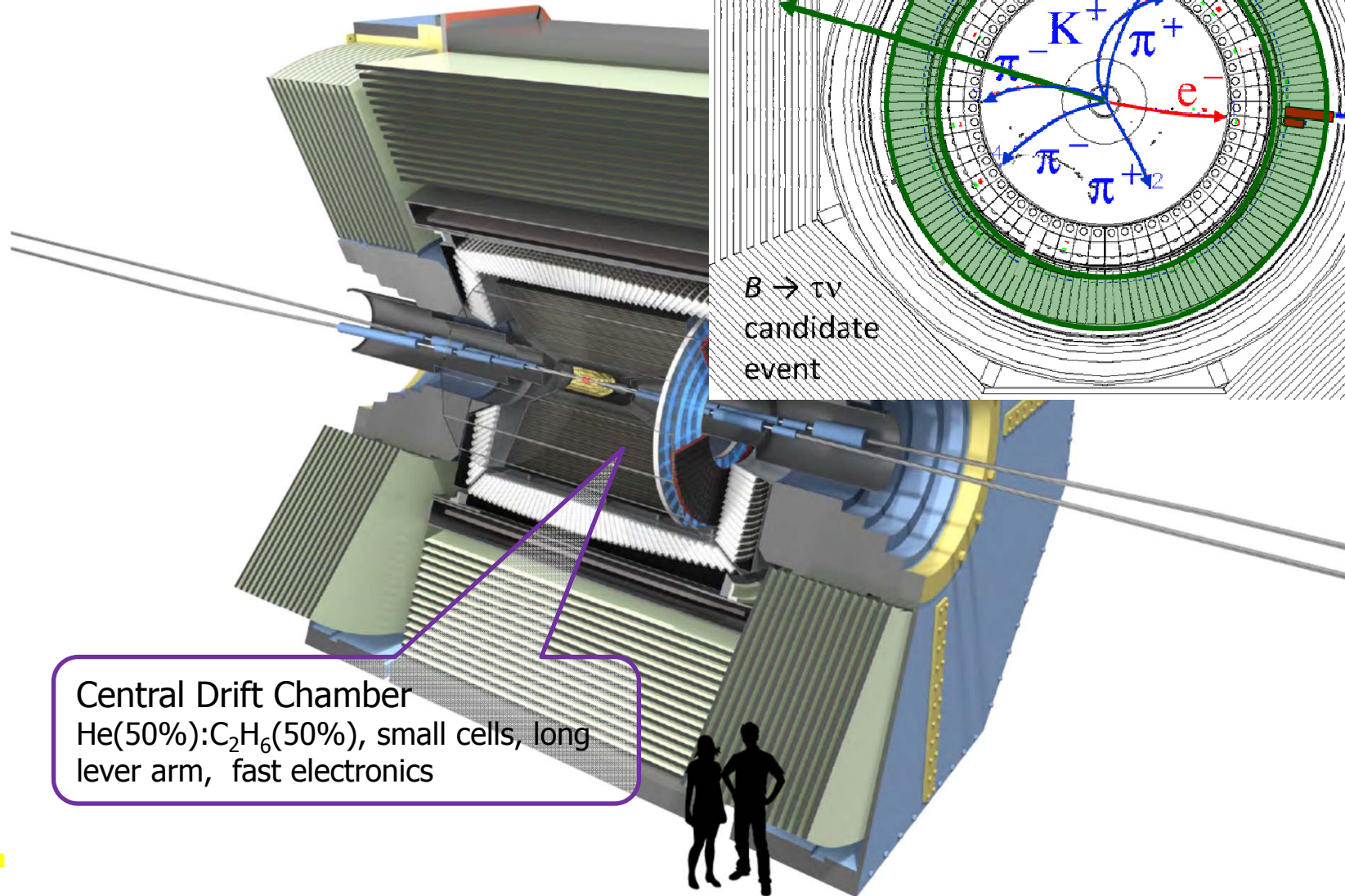

Central Drift Chamber
He(50%):C₂H₆(50%), small cells, long lever arm, fast electronics

Tracking: Belle central drift chamber



- 50 layers of wires (8400 cells) in 1.5 Tesla magnetic field
- Helium:Ethane 50:50 gas, W anode wires, Al field wires, CF inner wall with cathodes, and preamp only on endplates
- Particle identification from ionization loss (5.6-7% resolution)

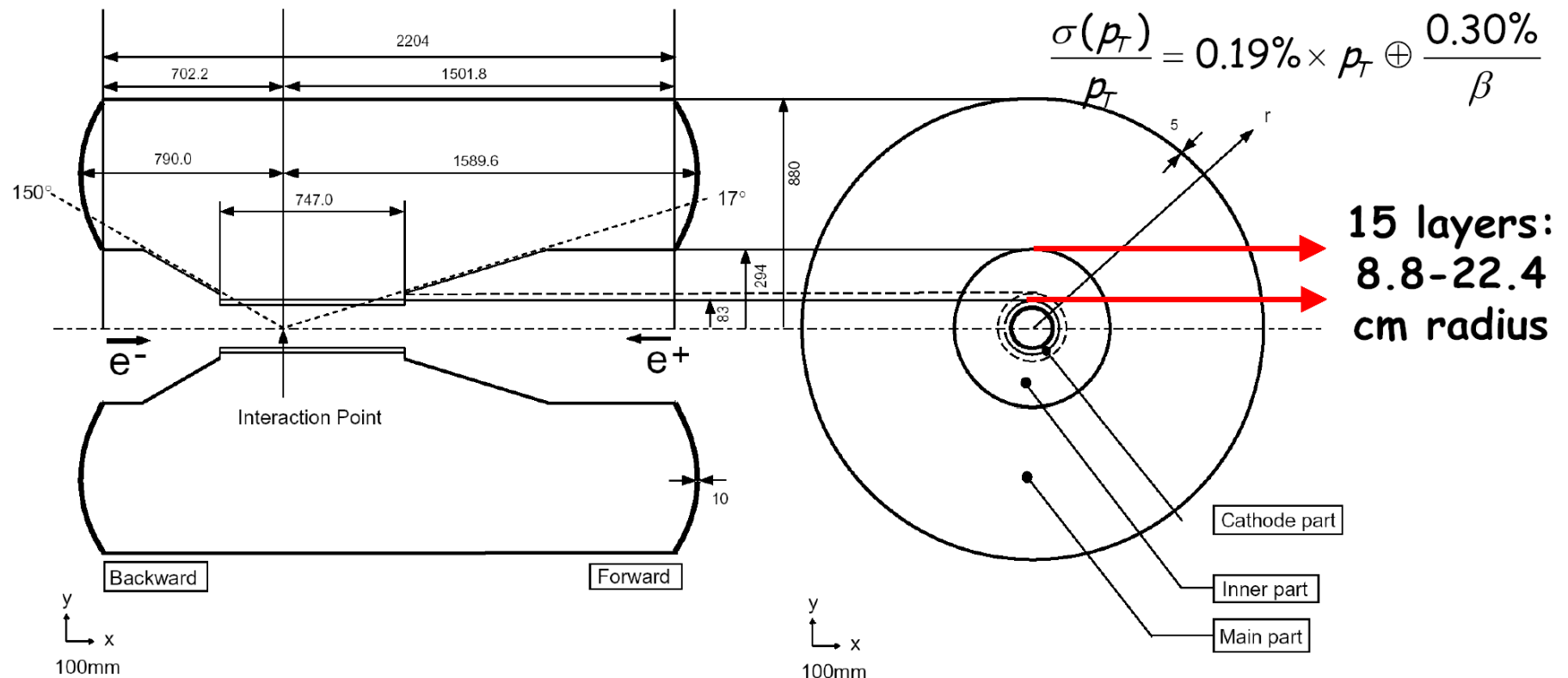

Drift chamber with small cells

One big gas volume, small cells defined by the anode wire and field shaping (potential) wires

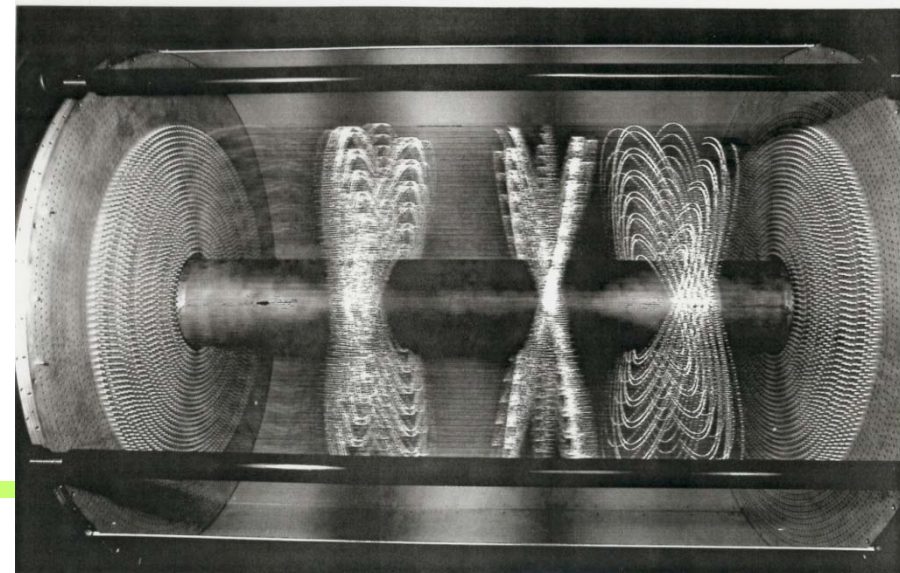
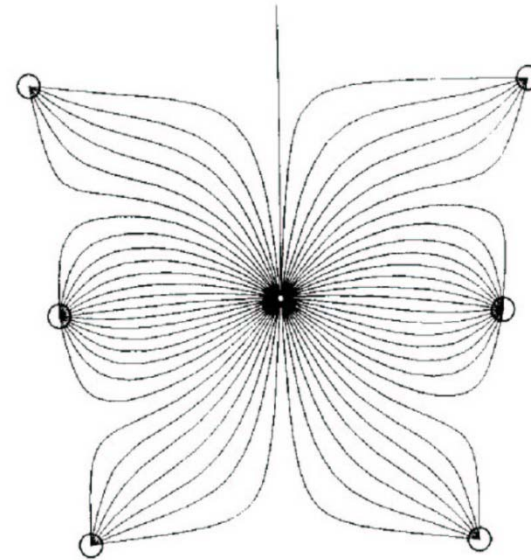
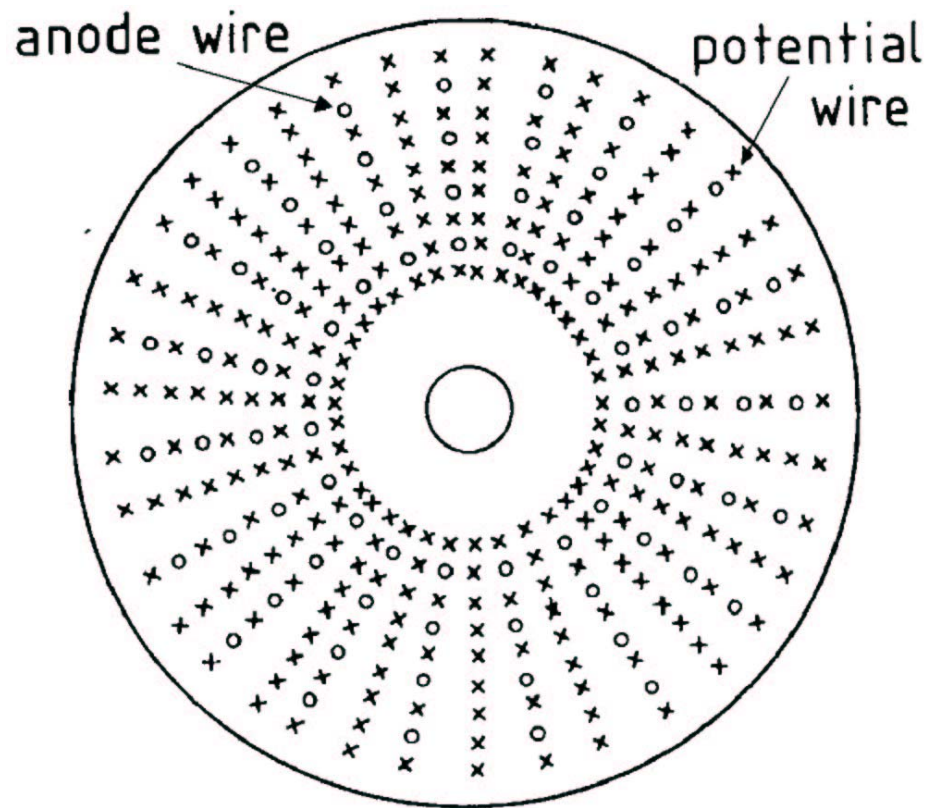

→ Gaseous detectors, Titov, Friday

Belle II CDC

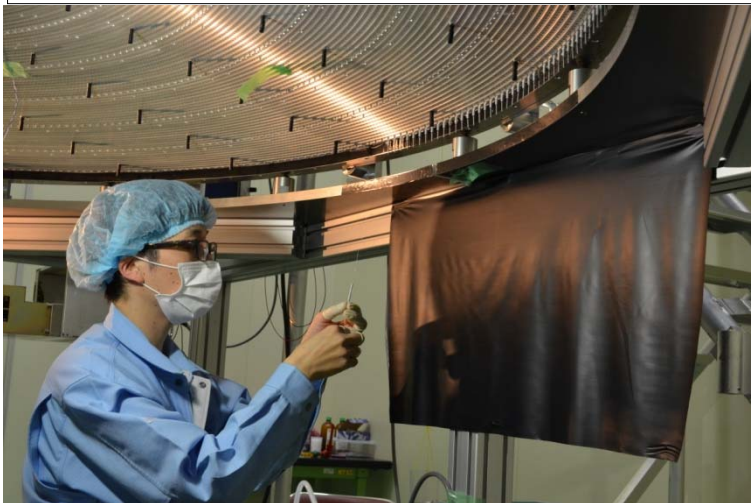
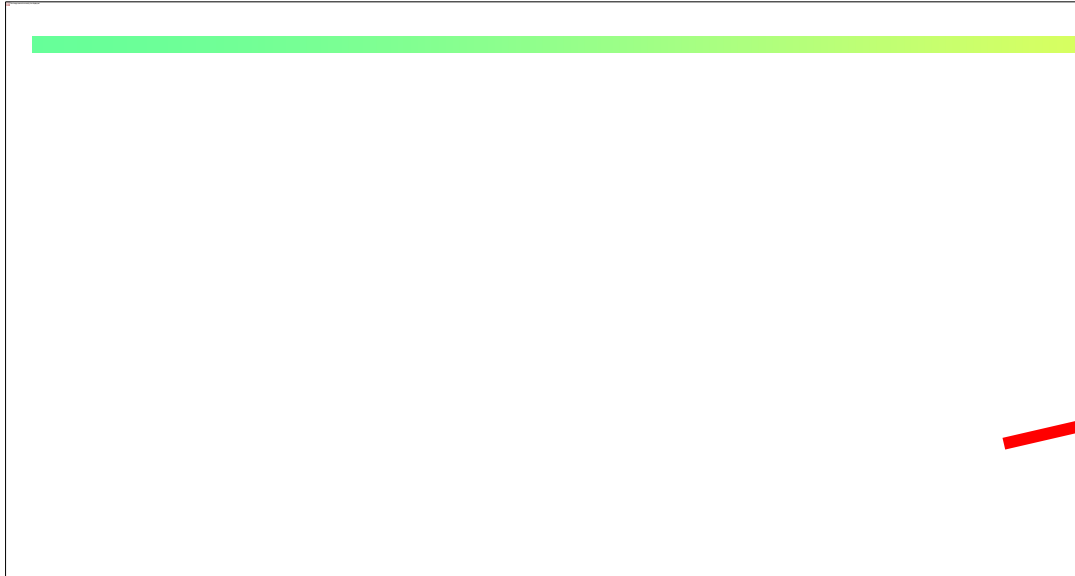

Wire stringing in a clean room

- thousands of wires,
- 1 year of work...
- Done!



Particle identification systems in Belle II

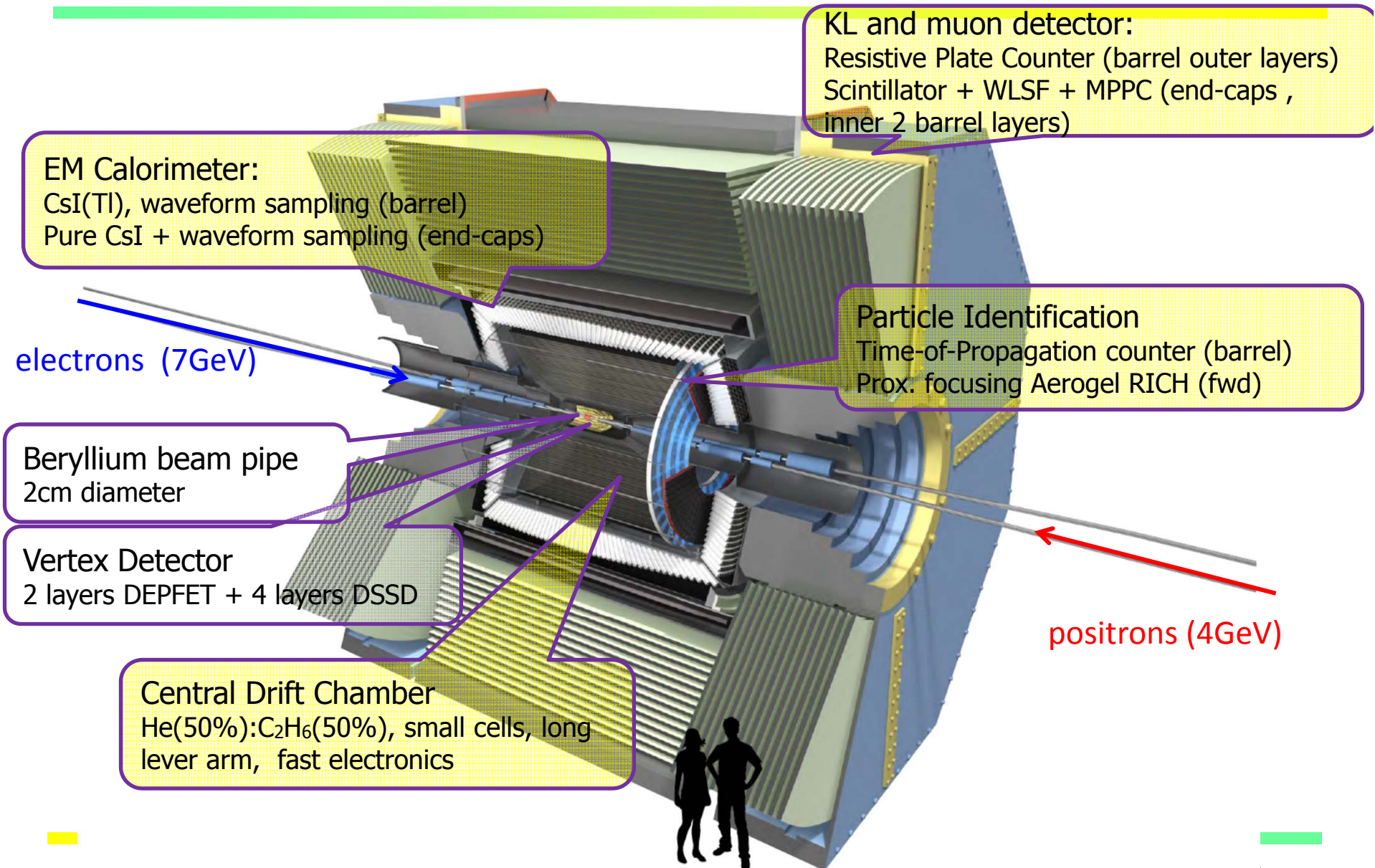

Identification of charged particles

Particles are identified by their **mass** or by the **way they interact**.

Determination of mass: from the relation between momentum and velocity, $p = \gamma m v$.

Momentum known (radius of curvature in magnetic field)

→ Measure velocity:

time of flight

ionisation losses dE/dx

Cherenkov angle

transition radiation

Mainly used for the identification of hadrons.

Identification through interaction: electrons and muons

Particle identification: pions and kaons

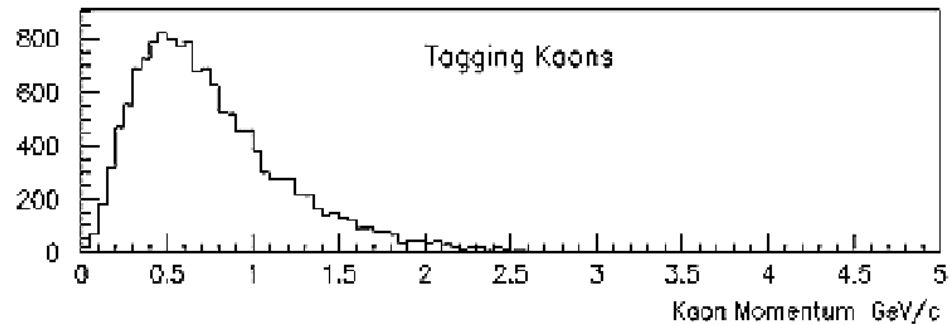

Tagging Kaons

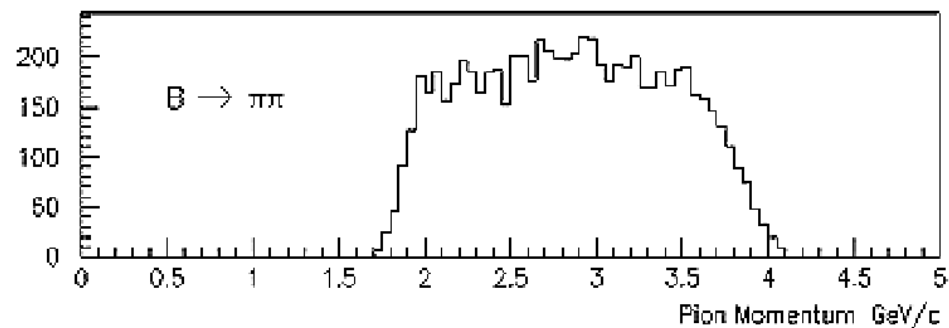

$B \rightarrow \pi\pi$

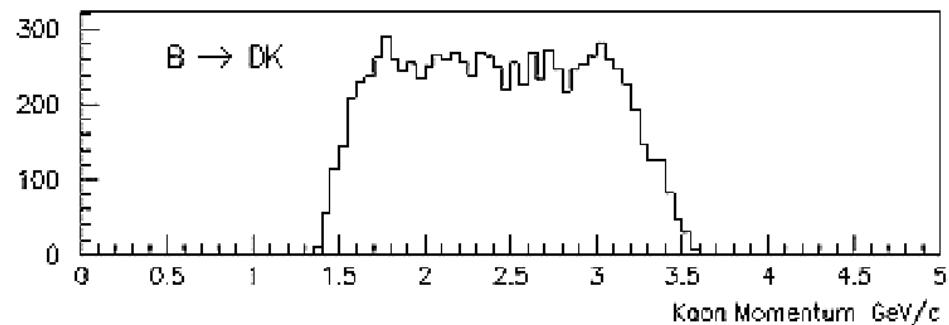

$B \rightarrow DK$

Identification with the dE/dx measurement

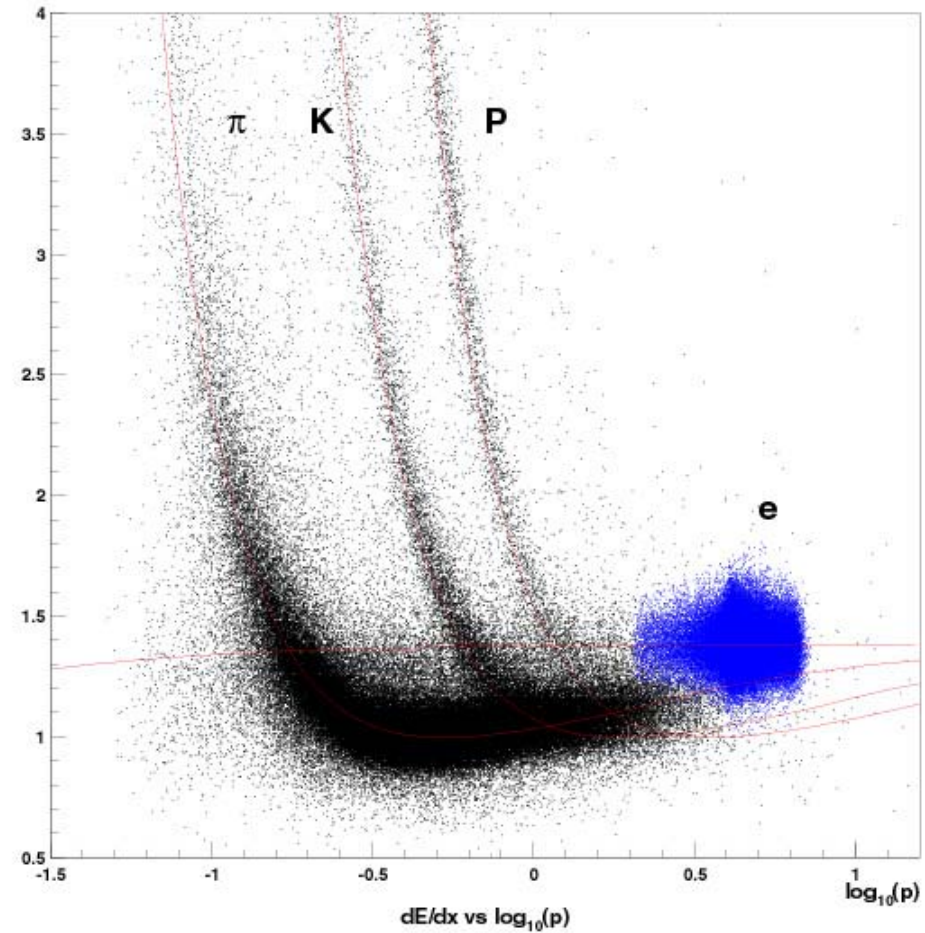
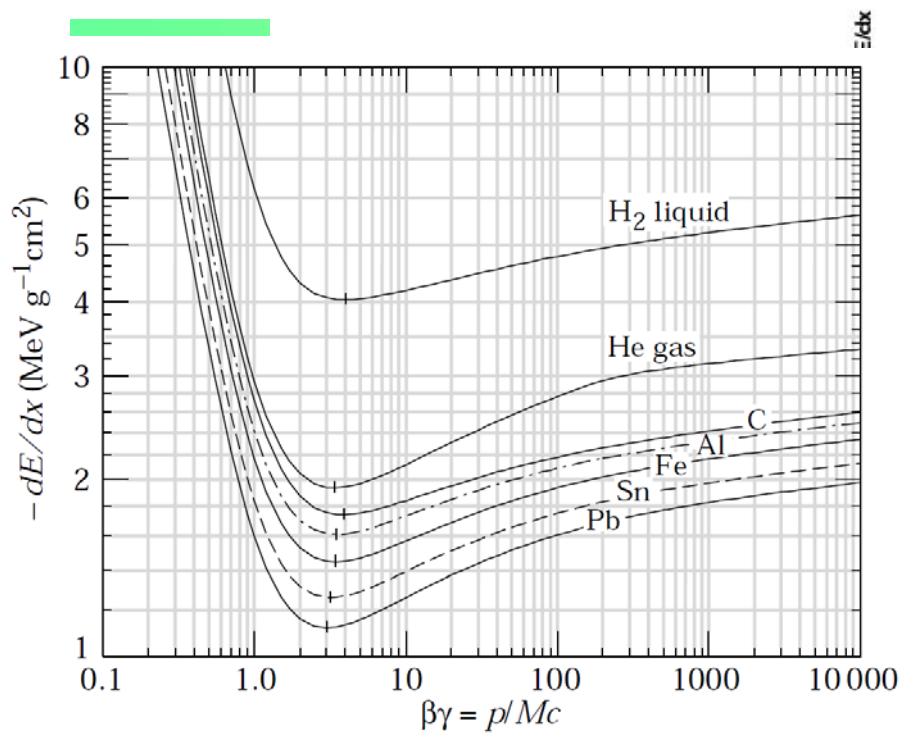

dE/dx is a function of velocity β

For particles with different mass the Bethe-Bloch curve gets displaced if plotted as a function of p

For good separation: resolution should be $\sim 5\%$

Measure in each drift chamber layer – use truncated mean

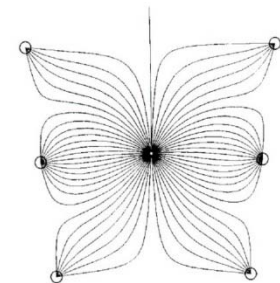

Cherenkov radiation

A charged track with velocity $v = \beta c$ exceeding the speed of light c/n in a medium with refractive index n emits **polarized light** at a characteristic (Cherenkov) angle,

$$\cos\theta = c/nv = 1/\beta n$$

Two cases:

- $\beta < \beta_t = 1/n$: below threshold **no** Cherenkov light is emitted.
- $\beta > \beta_t$: the number of Cherenkov photons emitted over unit photon energy $E = h\nu$ in a radiator of length L :

$$\frac{dN}{dE} = \frac{\alpha}{\hbar c} L \sin^2 \theta = 370(\text{cm})^{-1} (\text{eV})^{-1} L \sin^2 \theta$$

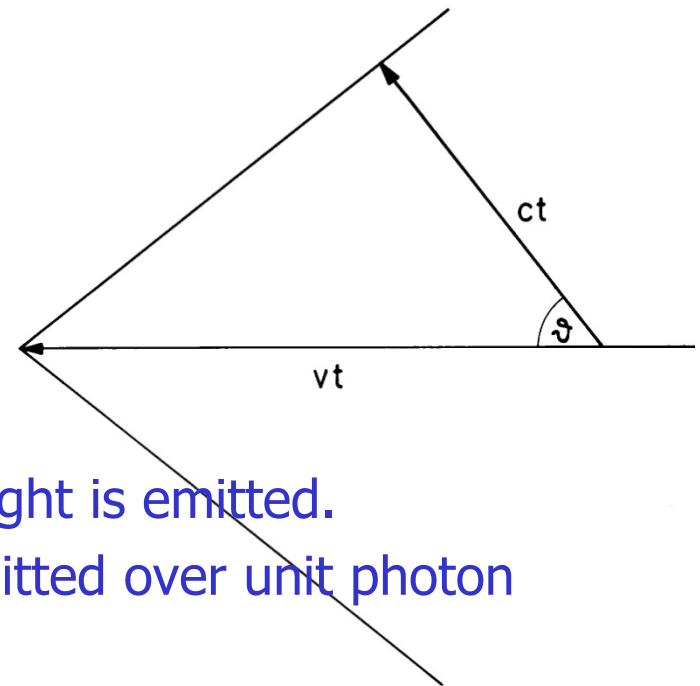

→ Few detected photons

Measuring the Cherenkov angle

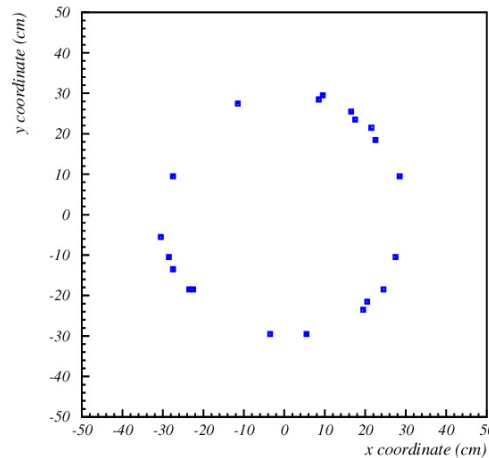
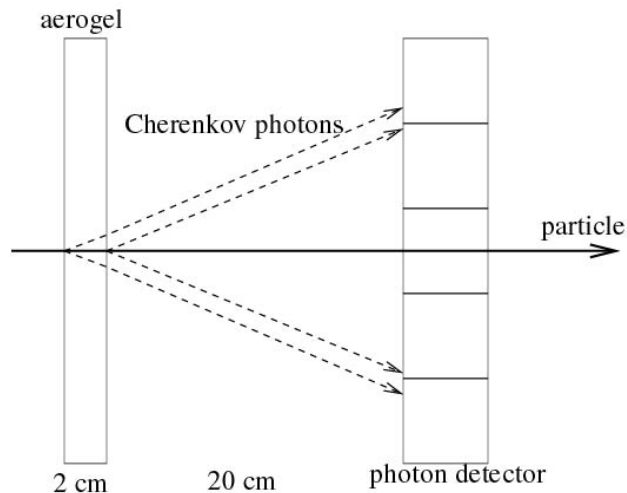

Idea: transform the direction into a coordinate → ring on the detection plane → Ring Imaging Cherenkov (RICH) counter

Proximity focusing RICH

RICH with a focusing mirror

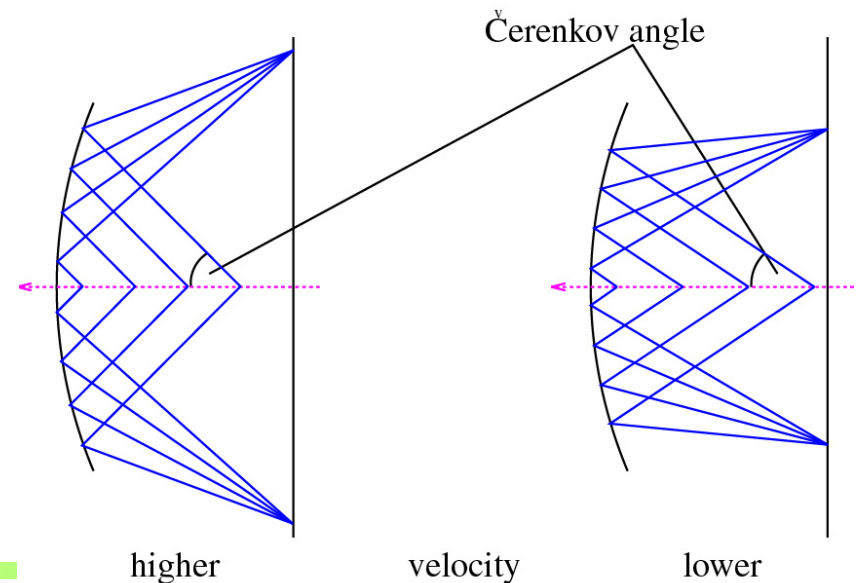

Aerogel RICH (endcap PID)

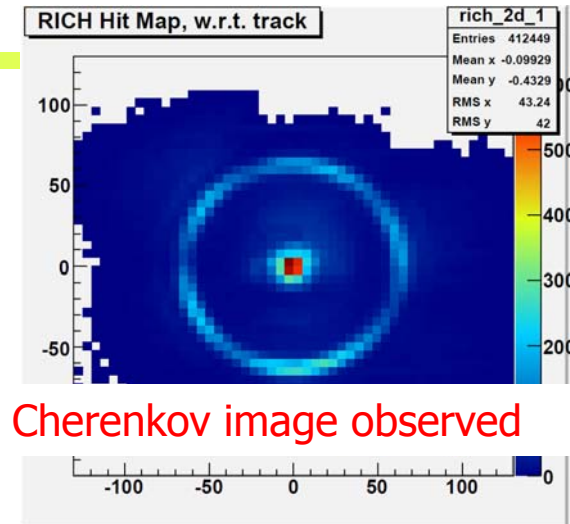
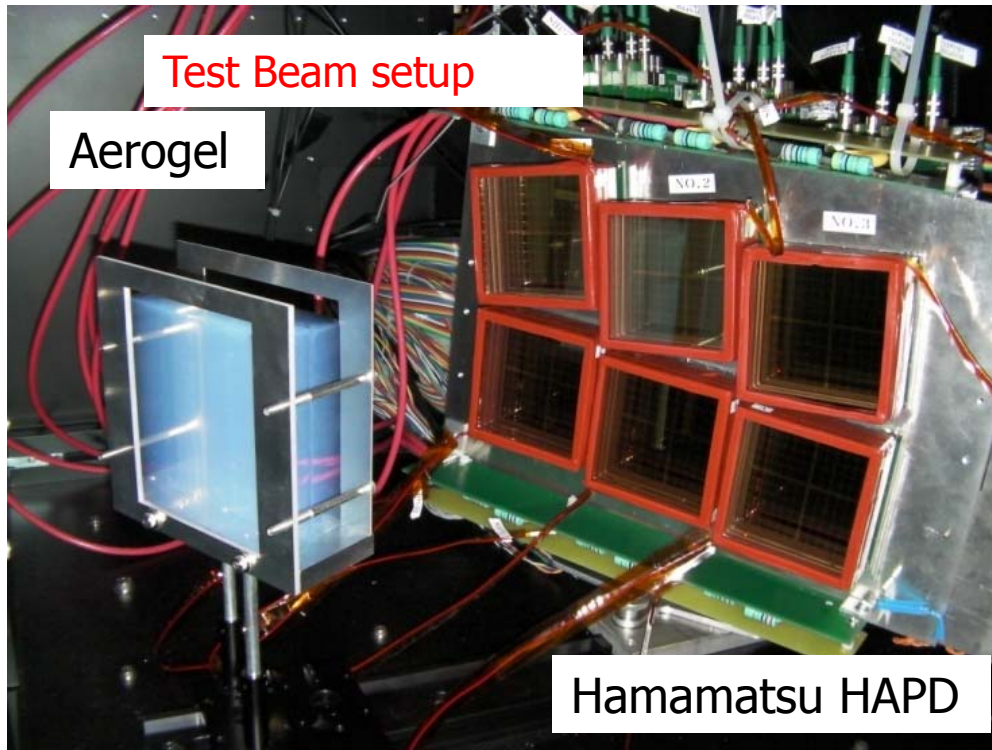

Clear Cherenkov image observed

Cherenkov angle distribution

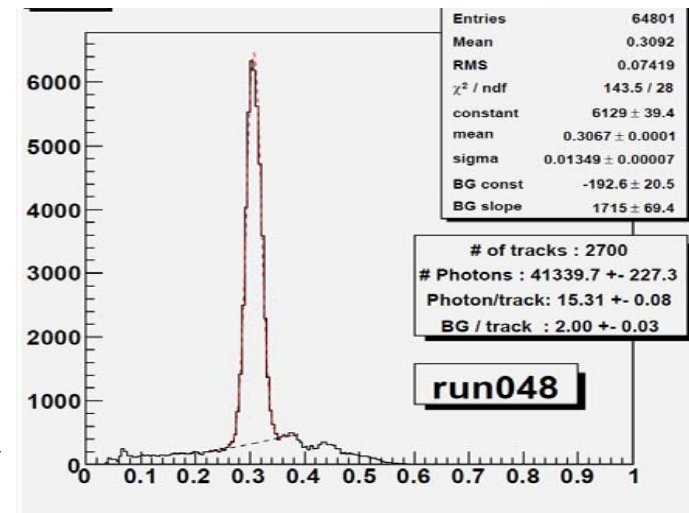

RICH with a novel "focusing" radiator – a two layer radiator

Employ multiple layers with different refractive indices → Cherenkov images from individual layers overlap on the photon detector.

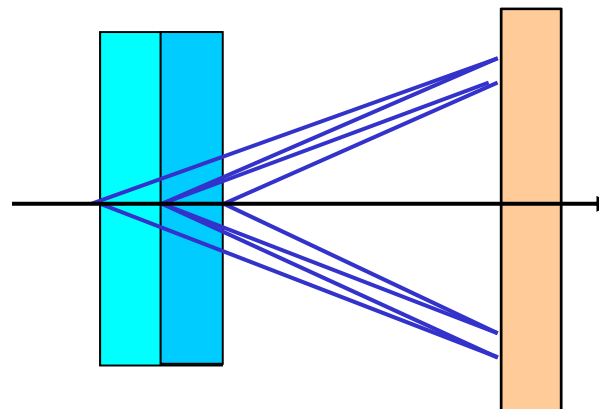

6.6 σ π /K at 4GeV/c!

Peter Križan, Ljubljana



Radiator with multiple refractive indices

How to increase the number of photons without degrading the resolution?

normal

→ stack two tiles with different refractive indices:
“focusing” configuration

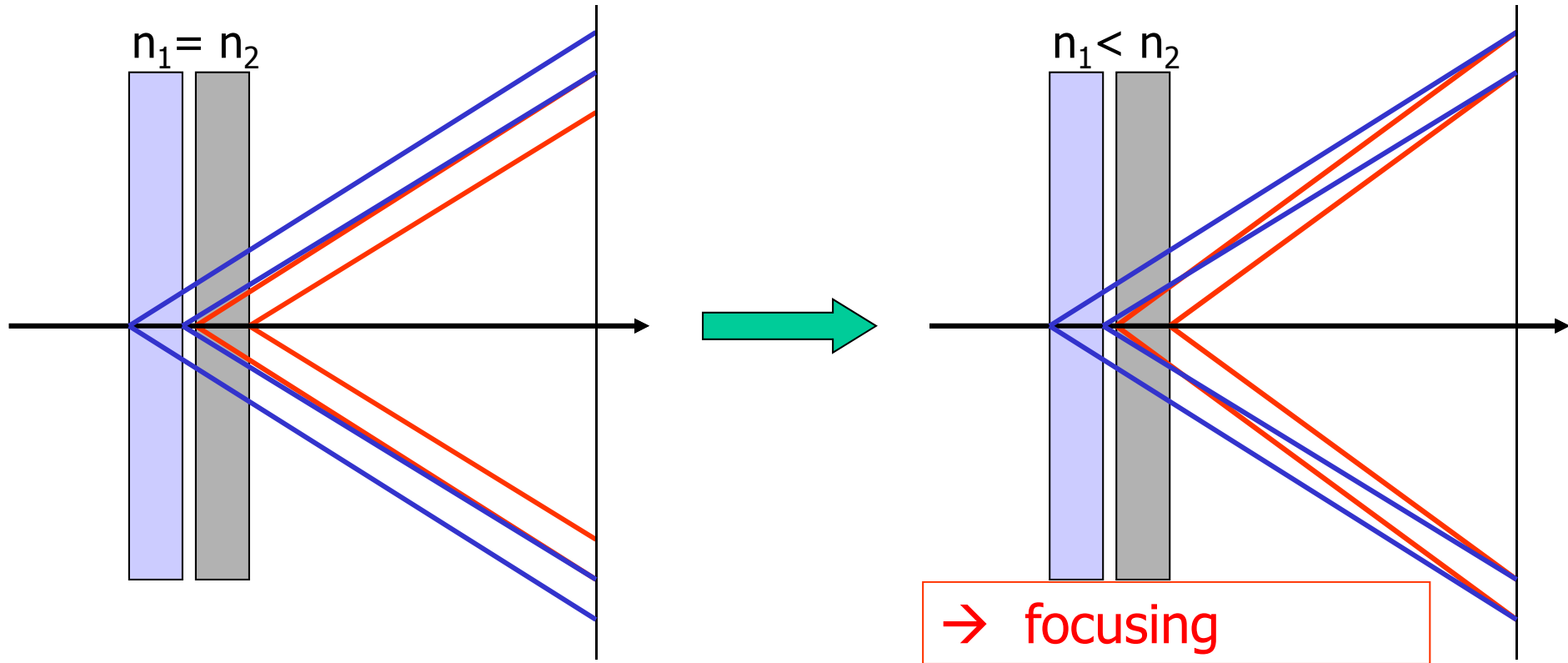

→ focusing

Such a configuration is only possible with aerogel (a form of Si_xO_y)
– material with a tunable refractive index between 1.01 and 1.13.



Focusing configuration – data

Increases the number of photons without degrading the resolution

4cm aerogel single index

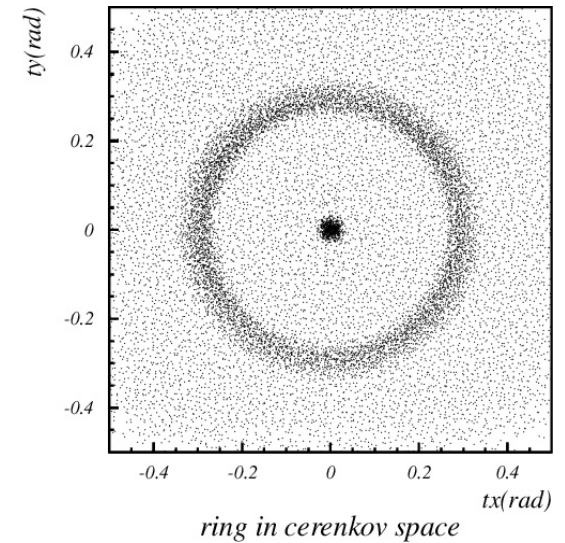
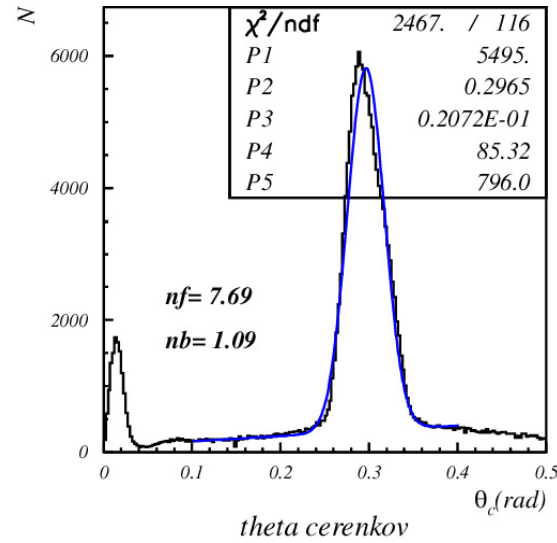
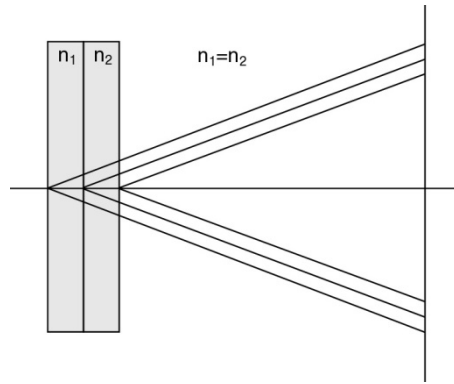

2+2cm aerogel

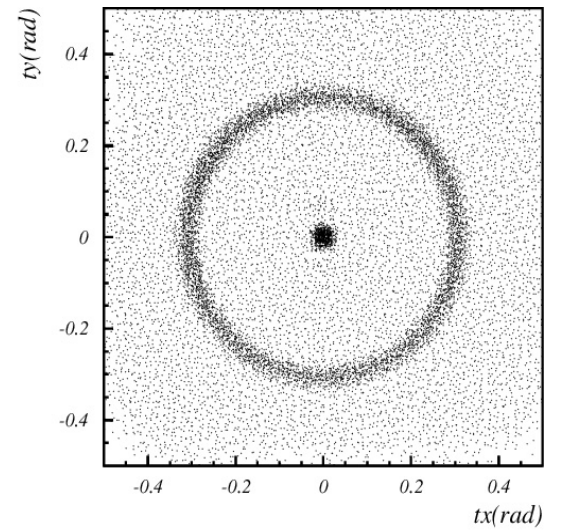
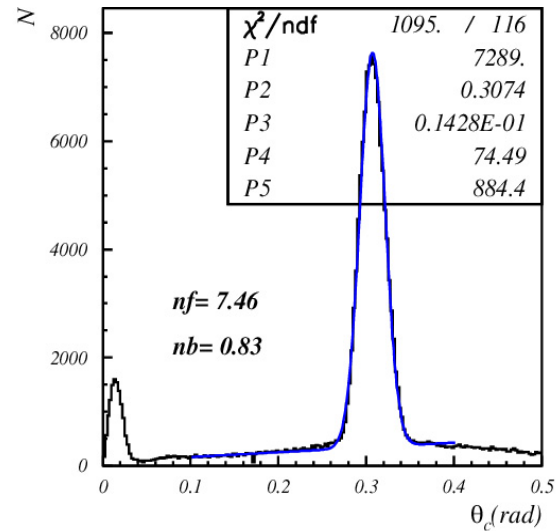
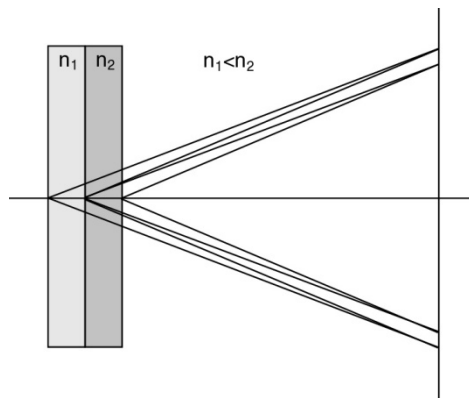

→ NIM A548 (2005) 383



Cherenkov detectors

Barrel PID: Time of Propagation Counter (TOP)

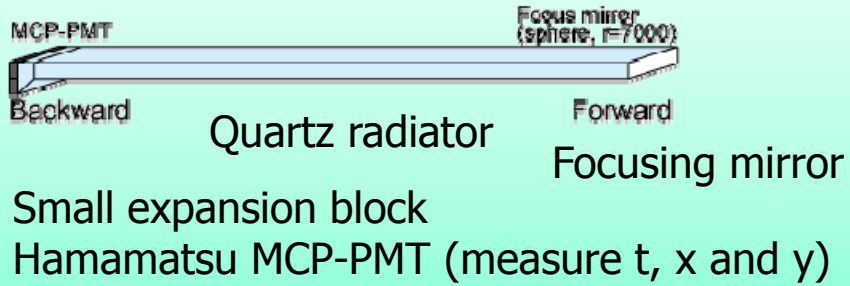

Endcap PID: Aerogel RICH (ARICH)

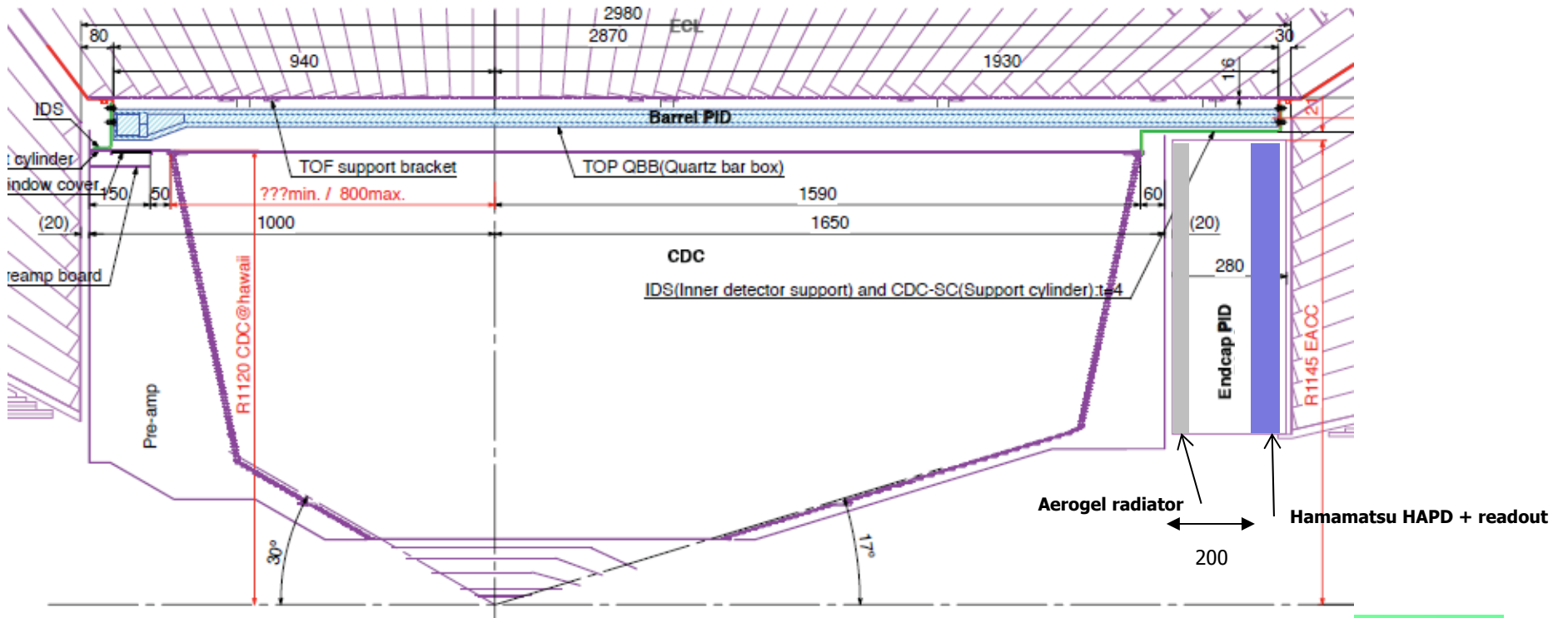
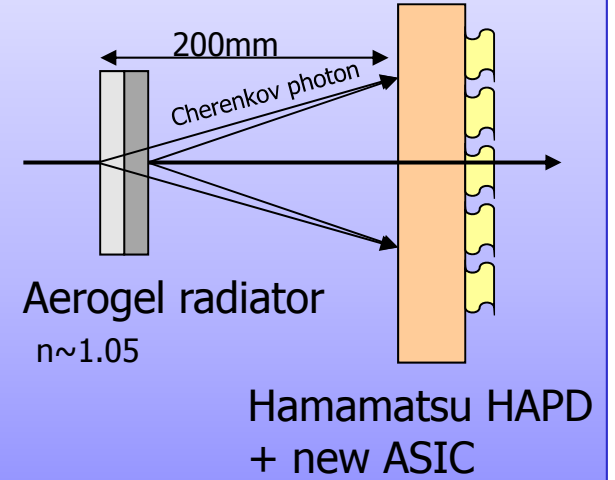

Peter Križan, Ljubljana

DIRC (@BaBar) - detector of internally reflected Cherenkov light

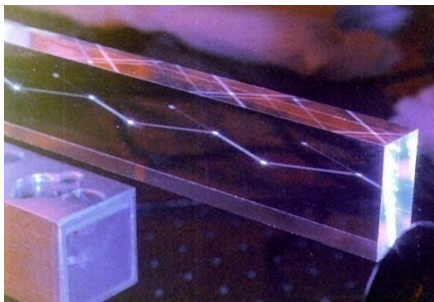
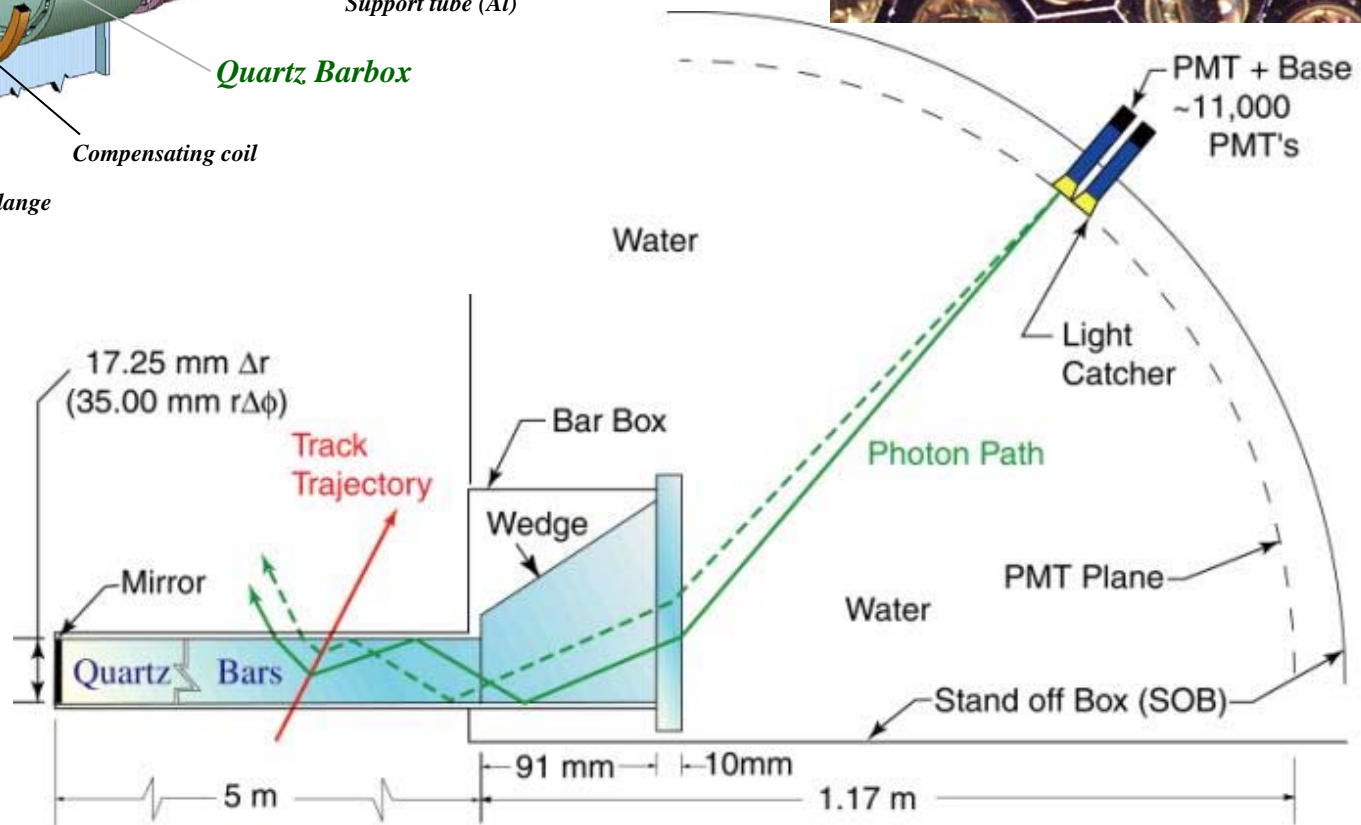
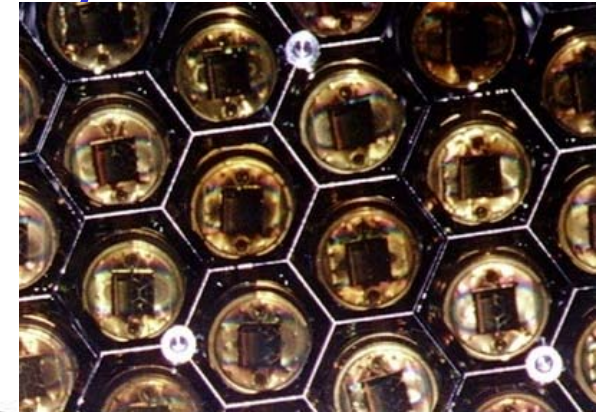
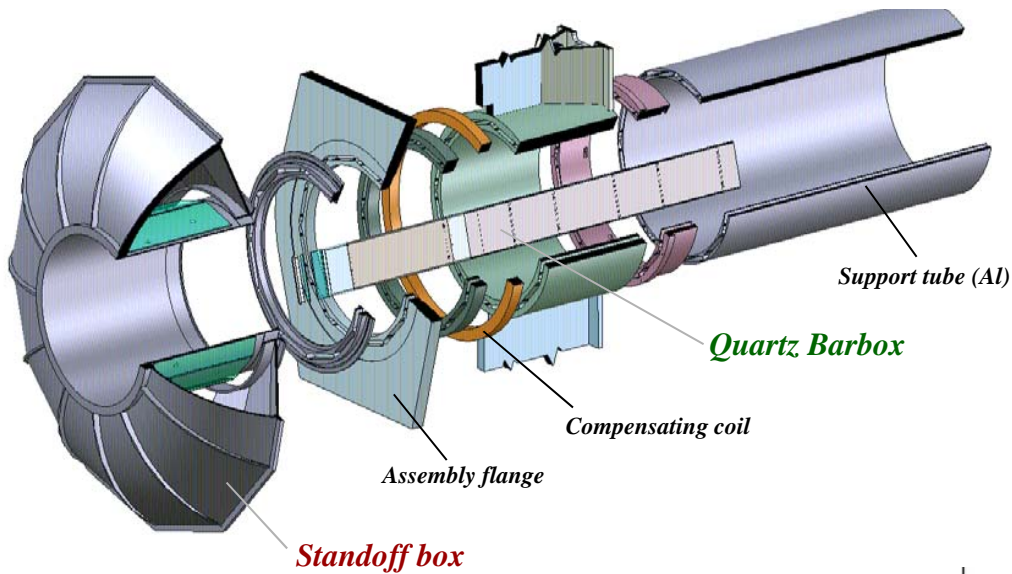

4 x 1.225 m Bars
glued end-to-end

Belle II Barrel PID: Time of propagation (TOP) counter

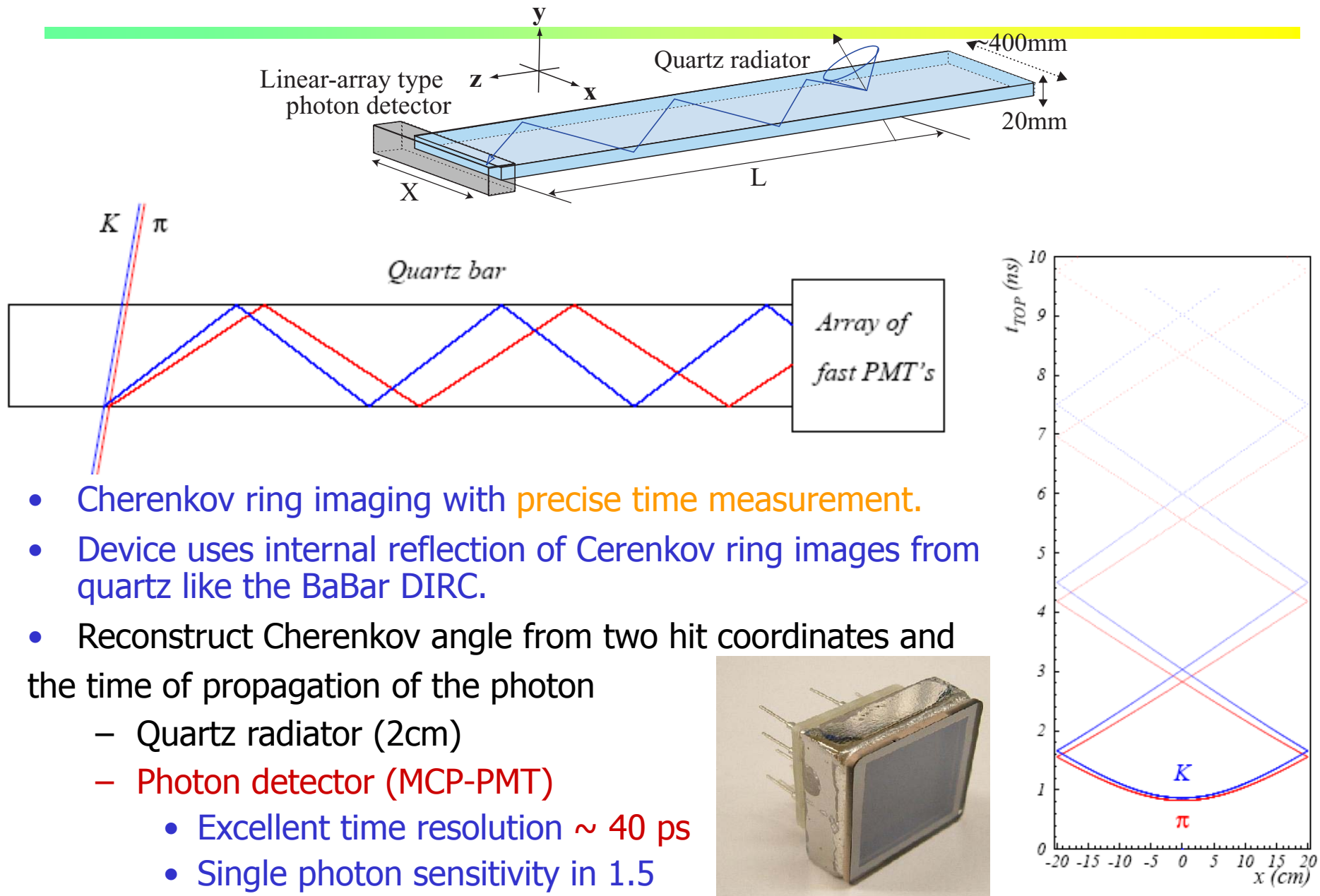

TOP image

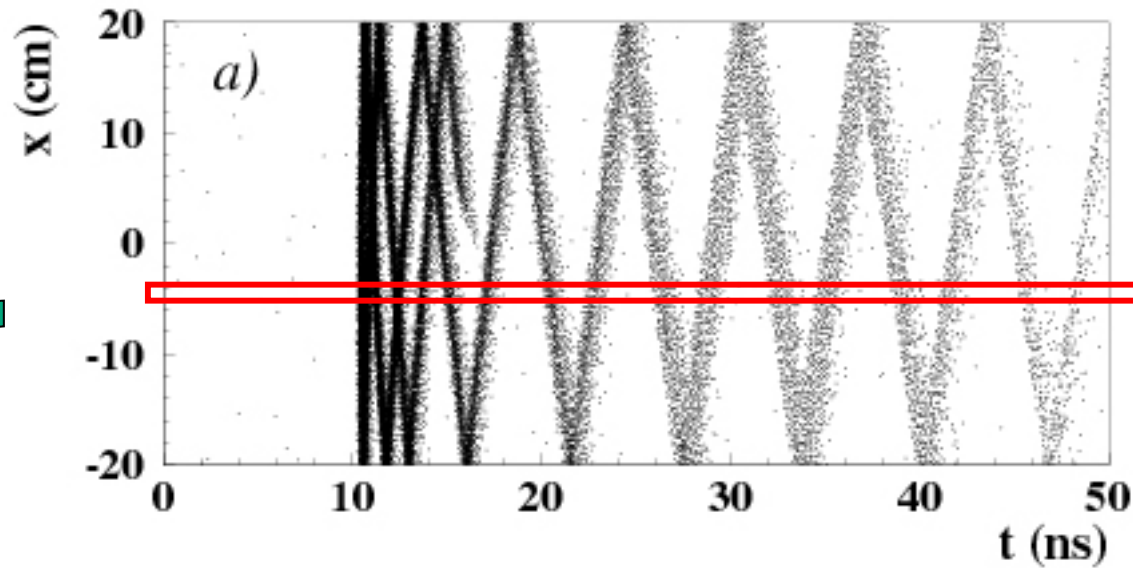

Pattern in the coordinate-time space ('ring') of a pion hitting a quartz bar with ~ 80 MAPMT channels

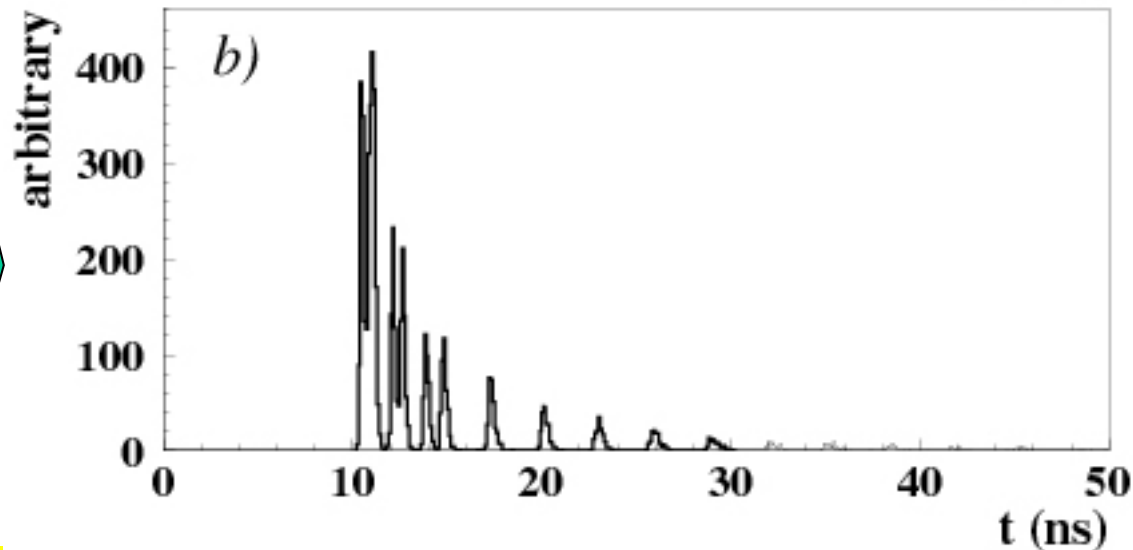

Time distribution of signals recorded by one of the PMT channels: different for π and K (\sim shifted in time)

Muon (and K_L) detector

Separate muons from hadrons (pions and kaons): exploit the fact that muons interact only e.m., while hadrons interact strongly \rightarrow need a few interaction lengths (about 10x radiation length in iron, 20x in CsI)

Detect K_L interaction (cluster): again need a few interaction lengths.

\rightarrow Put the detector outside the magnet coil, and integrate into the return yoke

Some numbers: 3.9 interaction lengths (iron)

Interaction length: iron 132 g/cm^2 , CsI 167 g/cm^2

$(dE/dx)_{\min}$: iron $1.45 \text{ MeV}/(\text{g/cm}^2)$, CsI $1.24 \text{ MeV}/(\text{g/cm}^2) \rightarrow \Delta E_{\min} = (0.36+0.11) \text{ GeV} = 0.47 \text{ GeV} \rightarrow$ identification of muons above $\sim 600 \text{ MeV}$

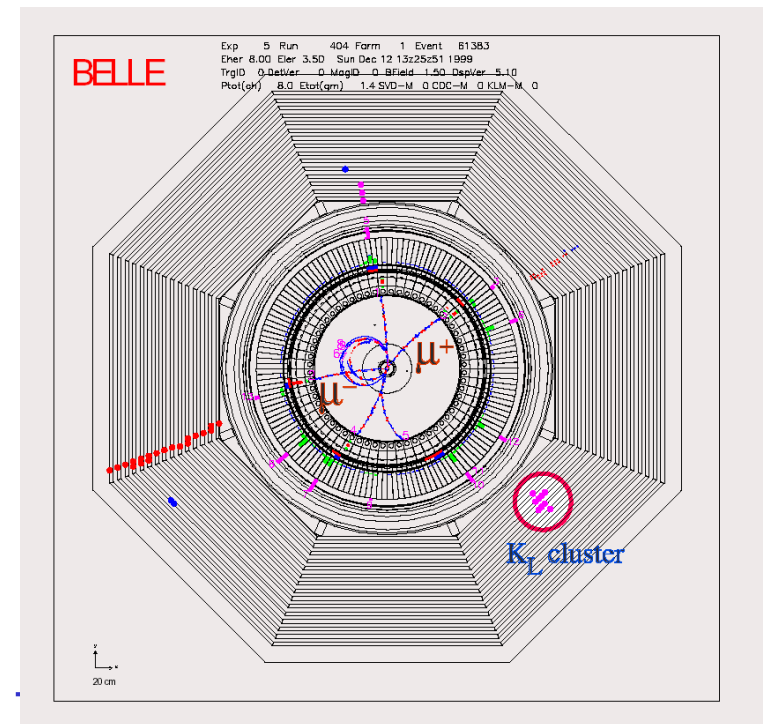

Muon and K_L detector

Example:

event with

- two muons and a
- K_L

and a pion that partly
penetrated.

Detector: resistive plate
chambers (RPC) in the
slits between ion plates

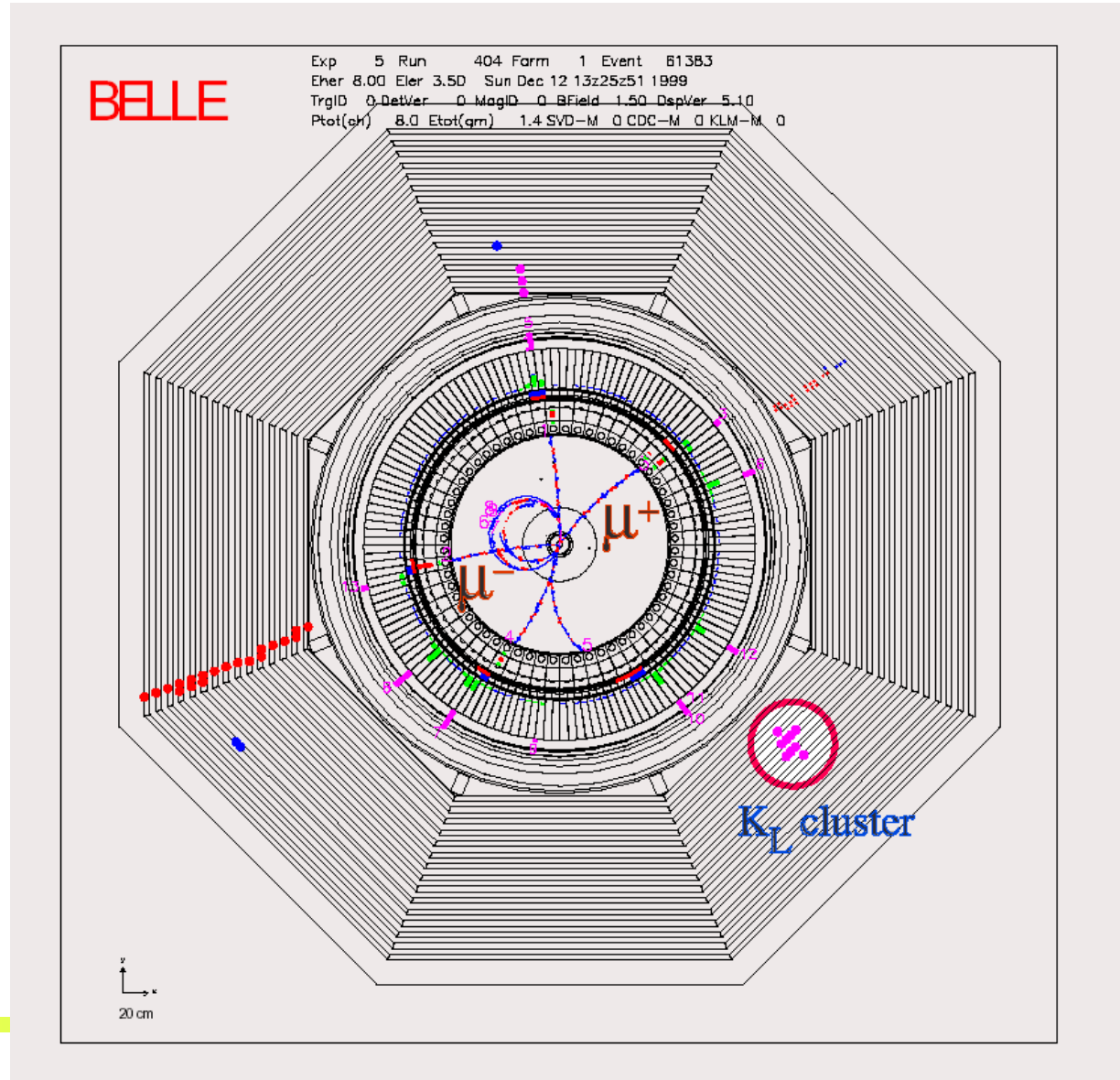

Muon and K_L detector performance

Muon identification >800 MeV/c

efficiency

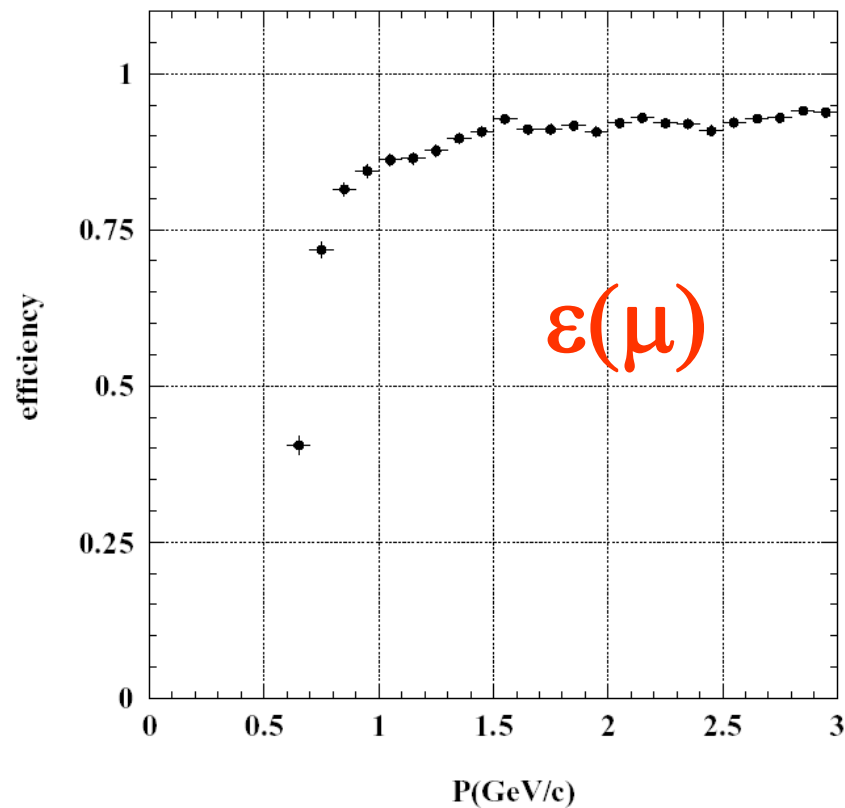

Fig. 109. Muon detection efficiency vs. momentum in KLM.

fake probability

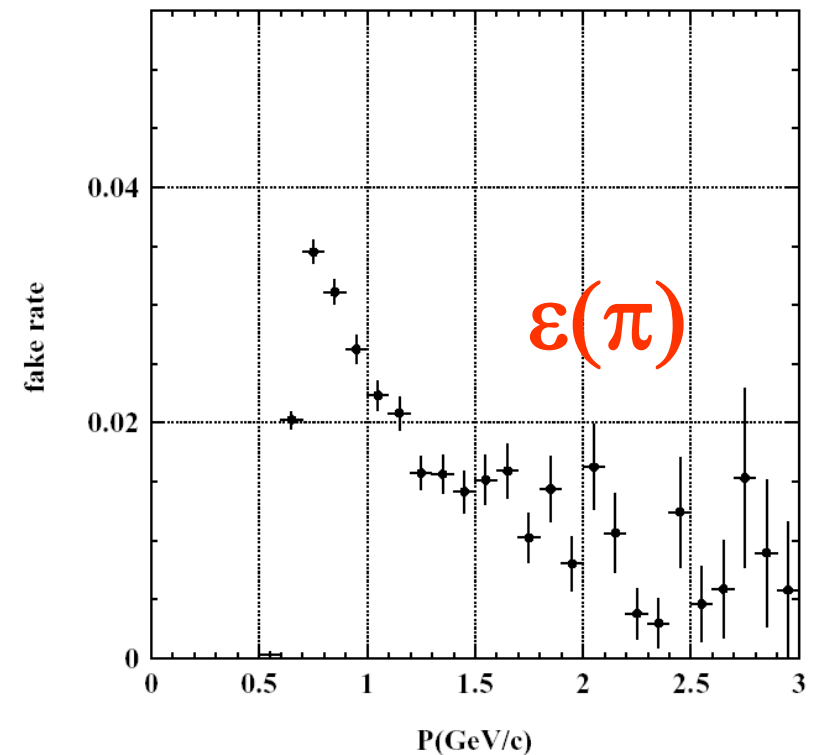

Fig. 110. Fake rate vs. momentum in KLM.

Muon and K_L detector performance

K_L detection: resolution in direction →

K_L detection: also possible with electromagnetic calorimeter (0.8 interaction lengths)

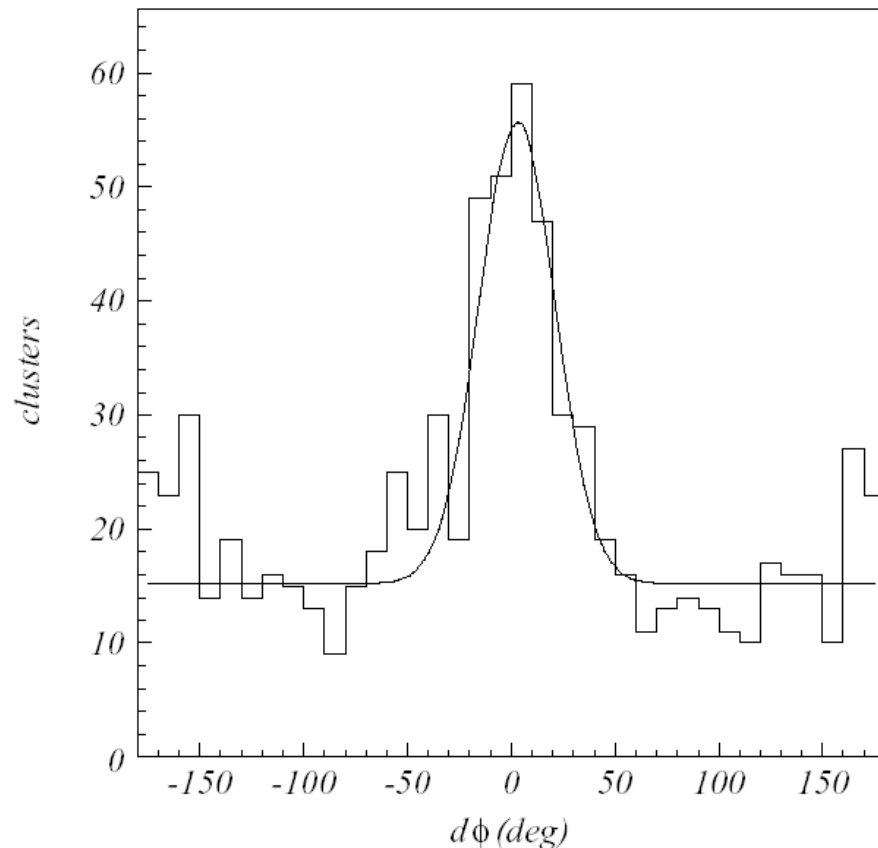
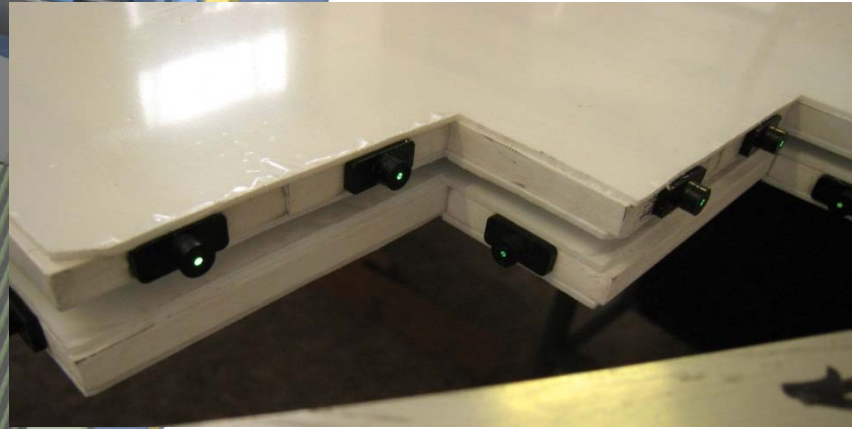
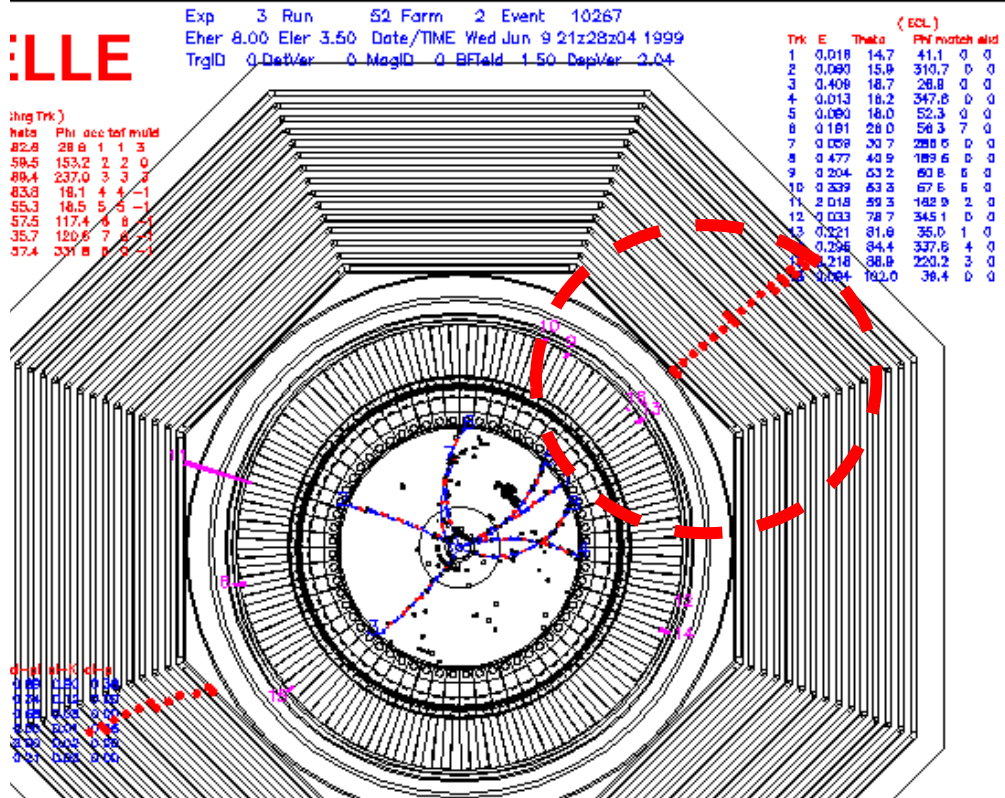
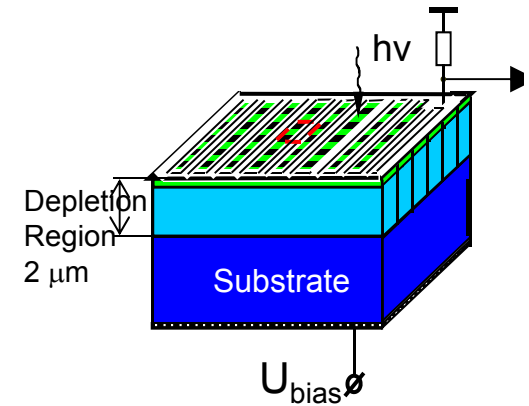
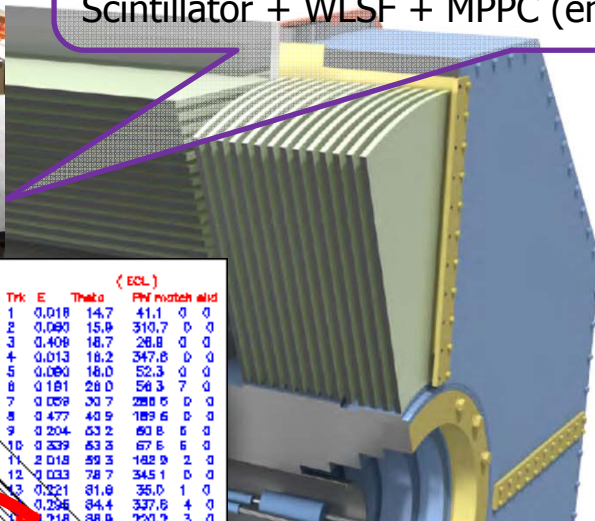
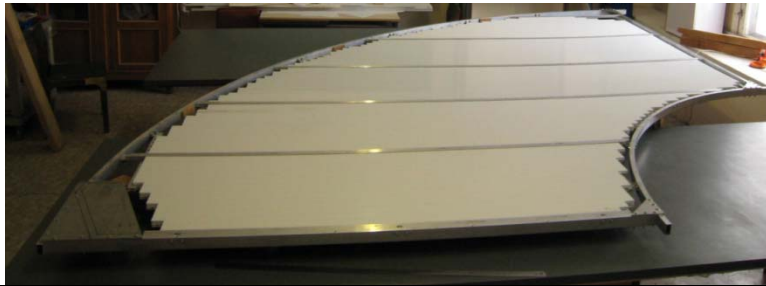

Fig. 107. Difference between the neutral cluster and the direction of missing momentum in KLM.

Belle II, detection of muons and K_L s: Parts of the present RPC system have to be replaced to handle higher backgrounds (mainly from neutrons).

K_L and muon detector:
Resistive Plate Chamber (barrel)
Scintillator + WLSF + MPPC (end-caps + barrel 2 inner layers)



ljana

Muon detection system upgrade in the endcaps

Scintillator-based KLM (endcap and two layers in the barrel part)

- Two independent (x and y) layers in one superlayer made of orthogonal strips with WLS read out
- Photo-detector = avalanche photodiode in Geiger mode (G-APD or SiPM)
- ~120 strips in one 90° sector (max L=280cm, w=25mm)
- ~30000 read out channels
- Geometrical acceptance > 99%

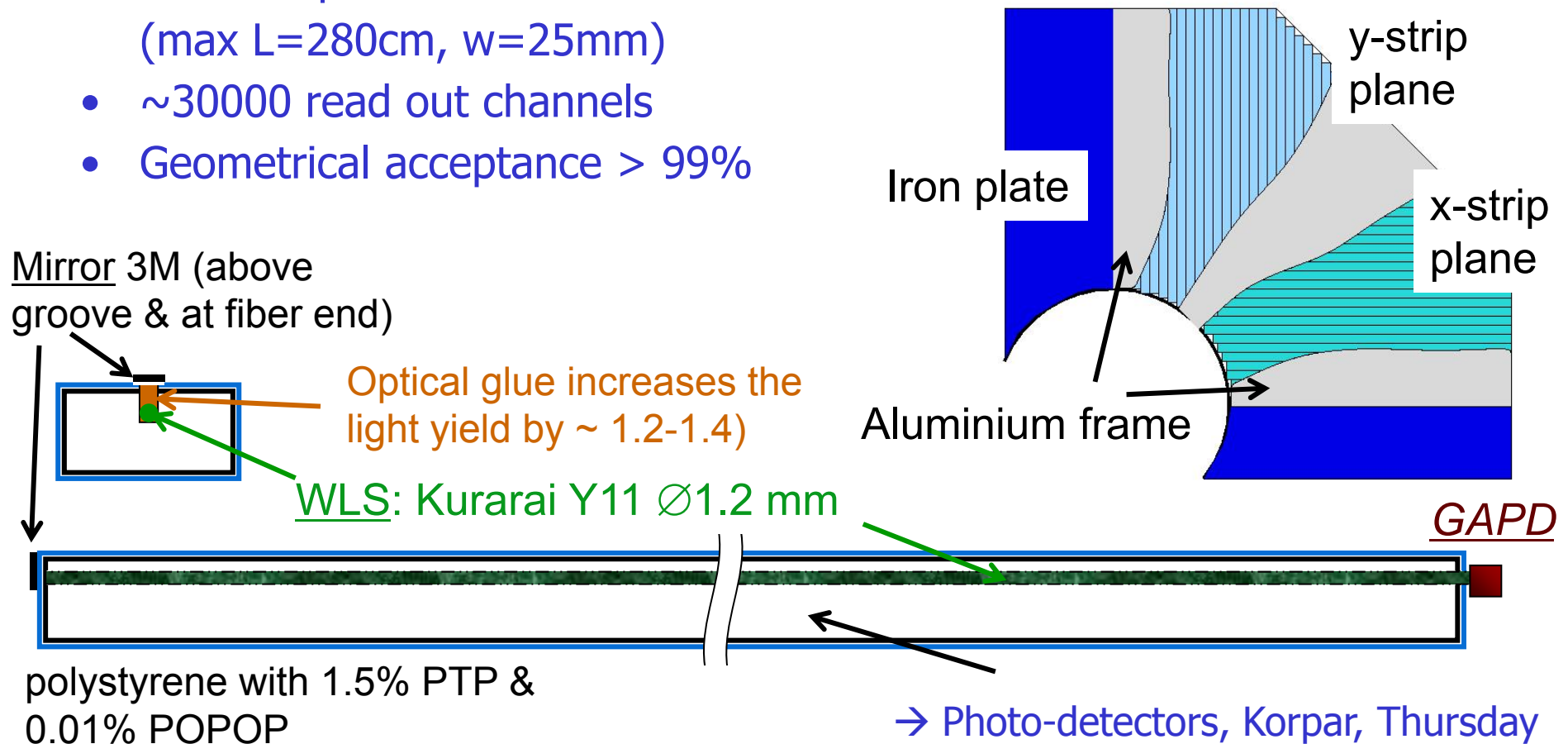

Calorimetry in Belle II

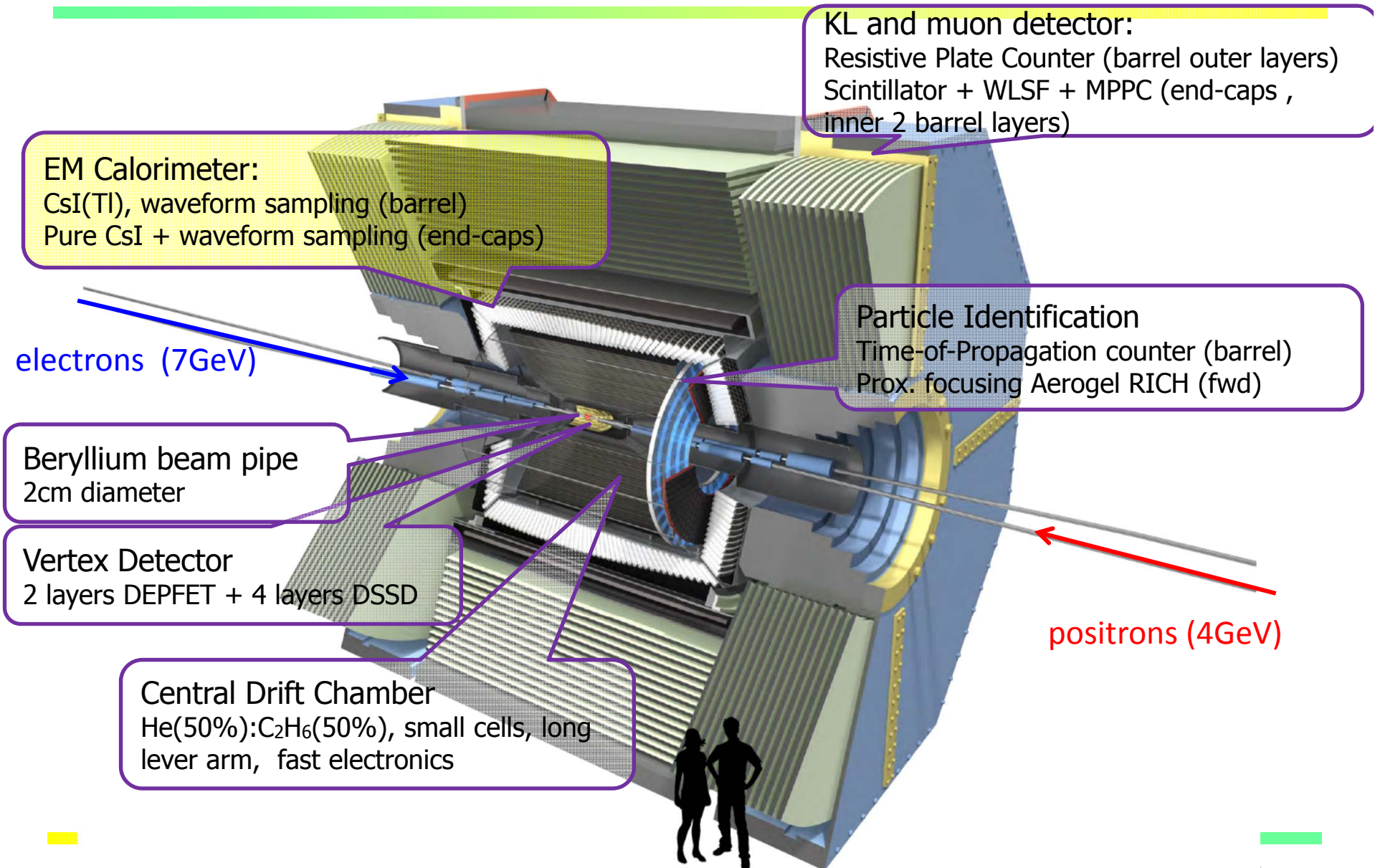

Requirements: Photons

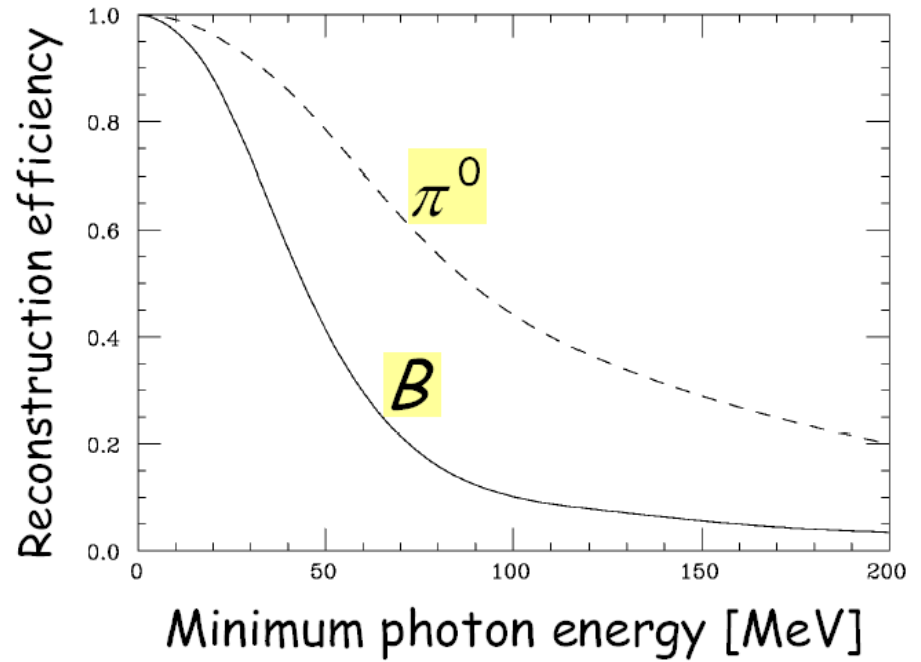
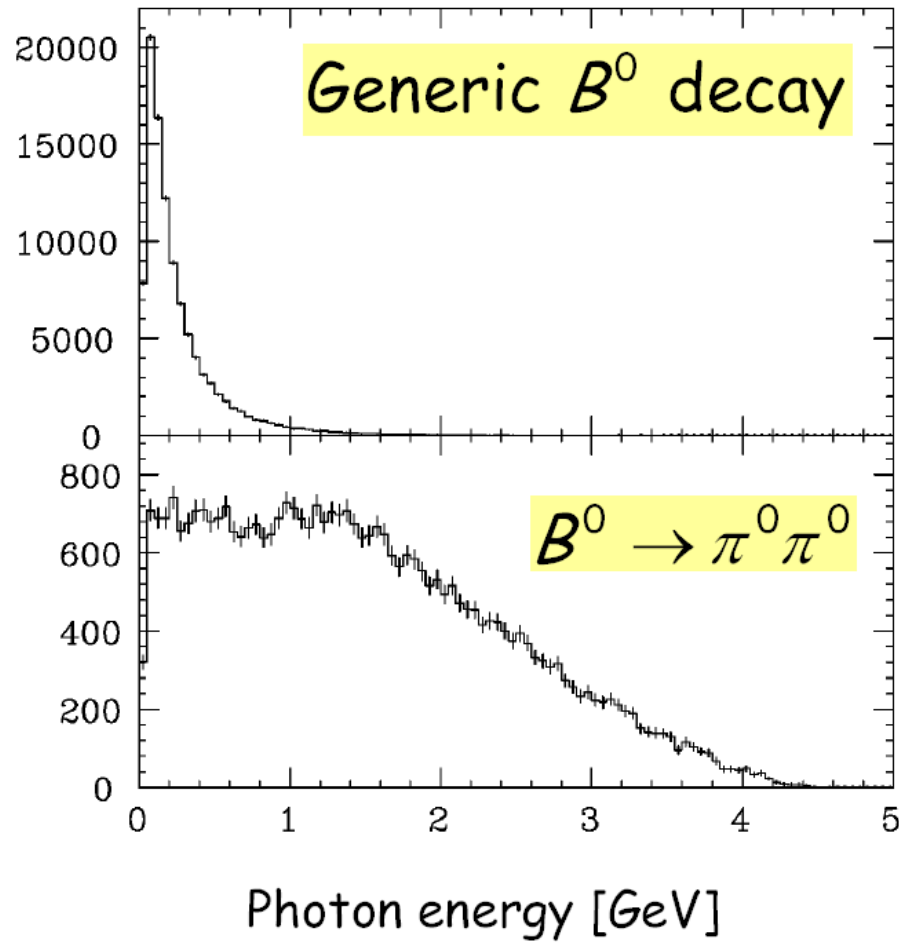

Belle II Detector (in comparison with Belle)

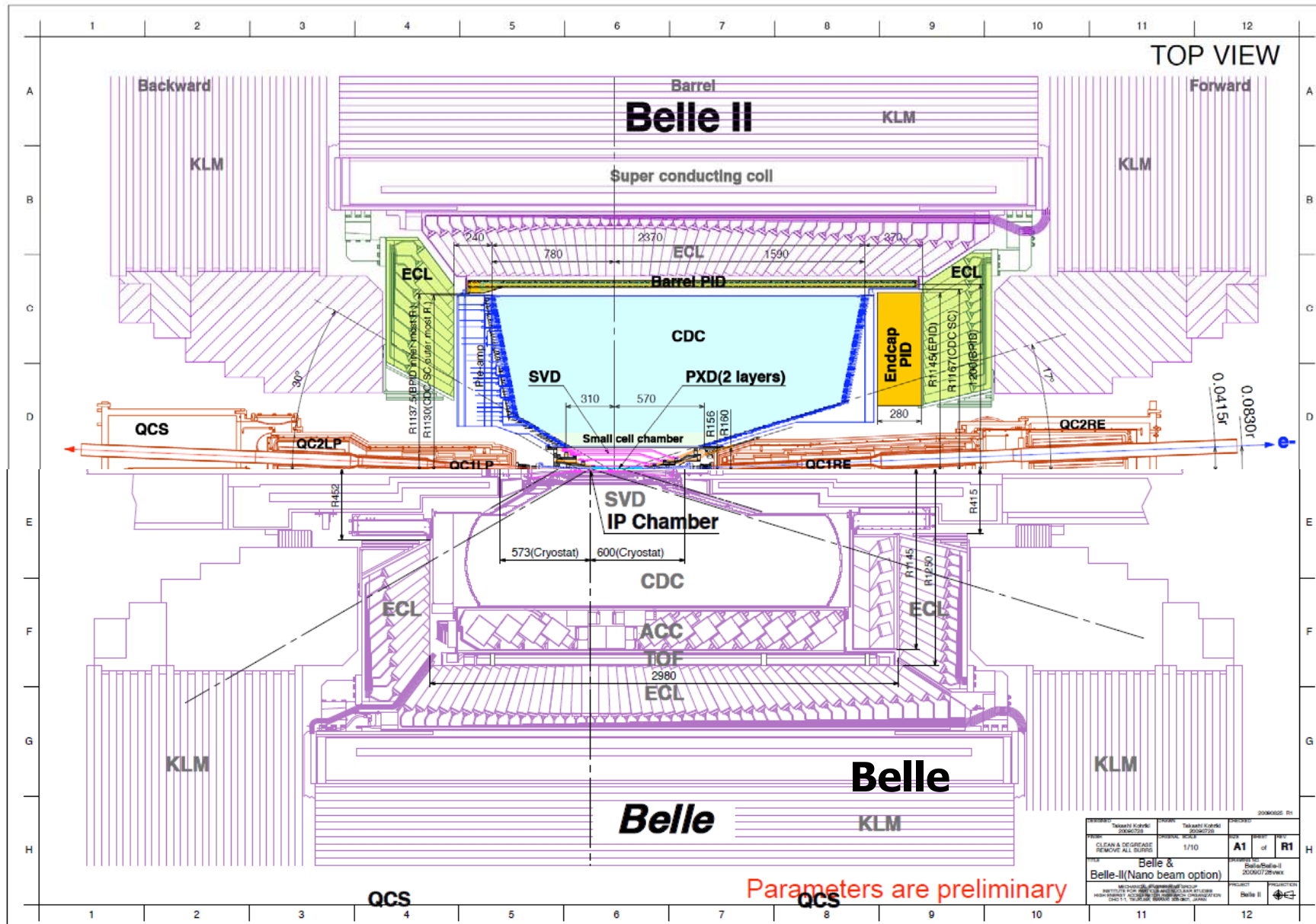

20090022 P1			
Author: Takashi Kuroki 20090720	Checker: Takashi Kuroki 20090720	Version: 1/10	Sheet: A1 of R1
CLEAN & DECREASE REMOVE ALL SURDS			
Project: Belle & Belle-II(Nano beam option)			
Mechanical Engineering Group HARIMA ELECTRONIC LABORATORY 1-1-1, HARIMA, TATEYAMA-CITY, MIYASHIRO-PREF. 789-2502, JAPAN			
Project: Belle II		Revision: 1	

EM calorimeter: upgrade needed because of **higher rates** and **radiation load**

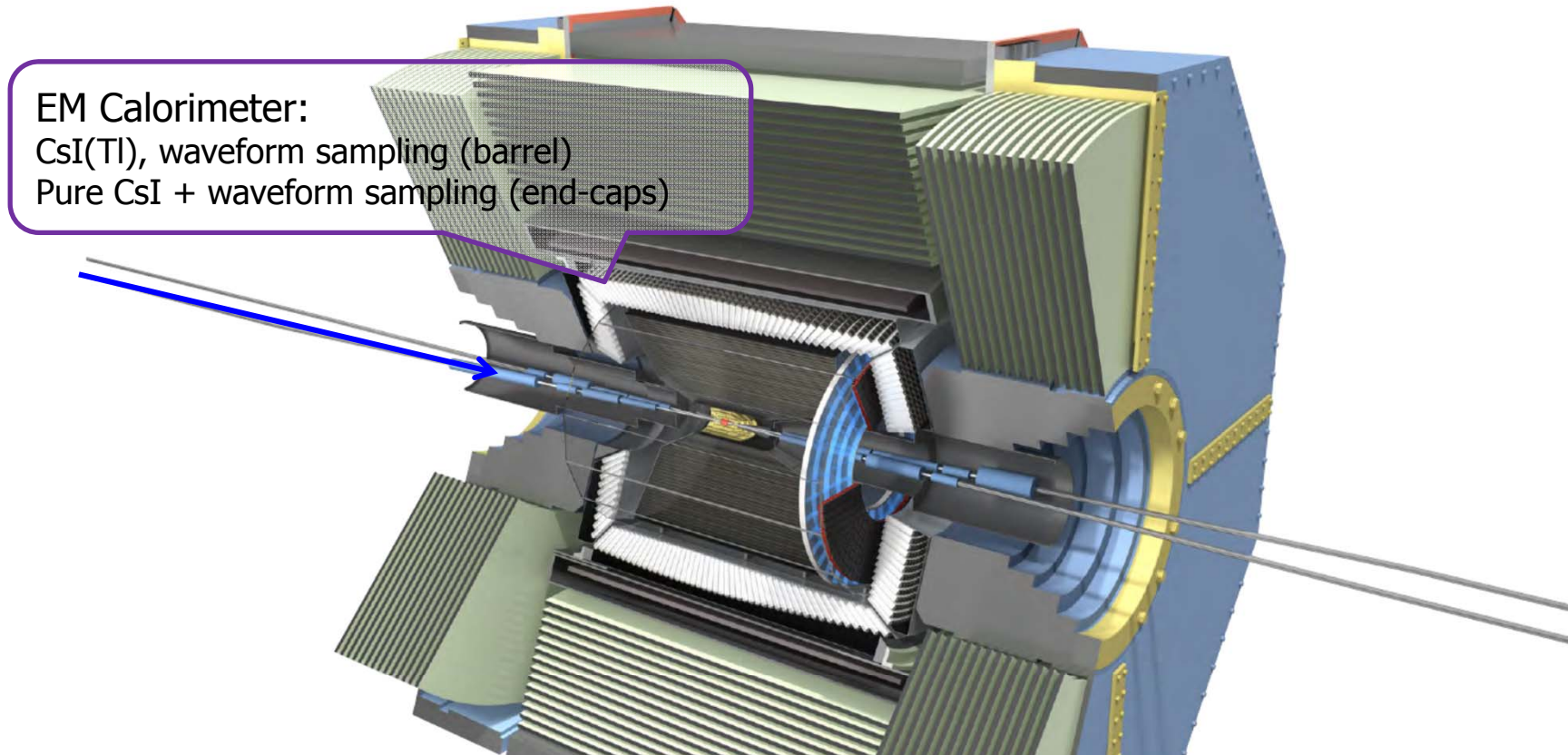

Present calorimeter:

- Scintillator: CsI(Tl)
 - Photosensor: photodiode
- ... by far the most expensive single component

→ Calorimeters,
Paramatti, Thursday

- EM calorimeter: upgrade needed because of
- higher rates (barrel: **electronics**, endcap: **electronics** and CsI(Tl) → **pure CsI**), and
 - radiation load (endcap: CsI(Tl) → **pure CsI**)

Pure CsI is faster, but has a smaller light yield...
→replace photodiodes with a special kind of PMT (photopentode) that can be operated in magnetic field

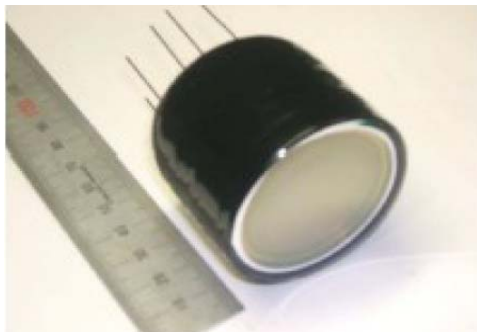

Status of the project

The Belle II Collaboration



A very strong group of ~600 highly motivated scientists!

Schedule

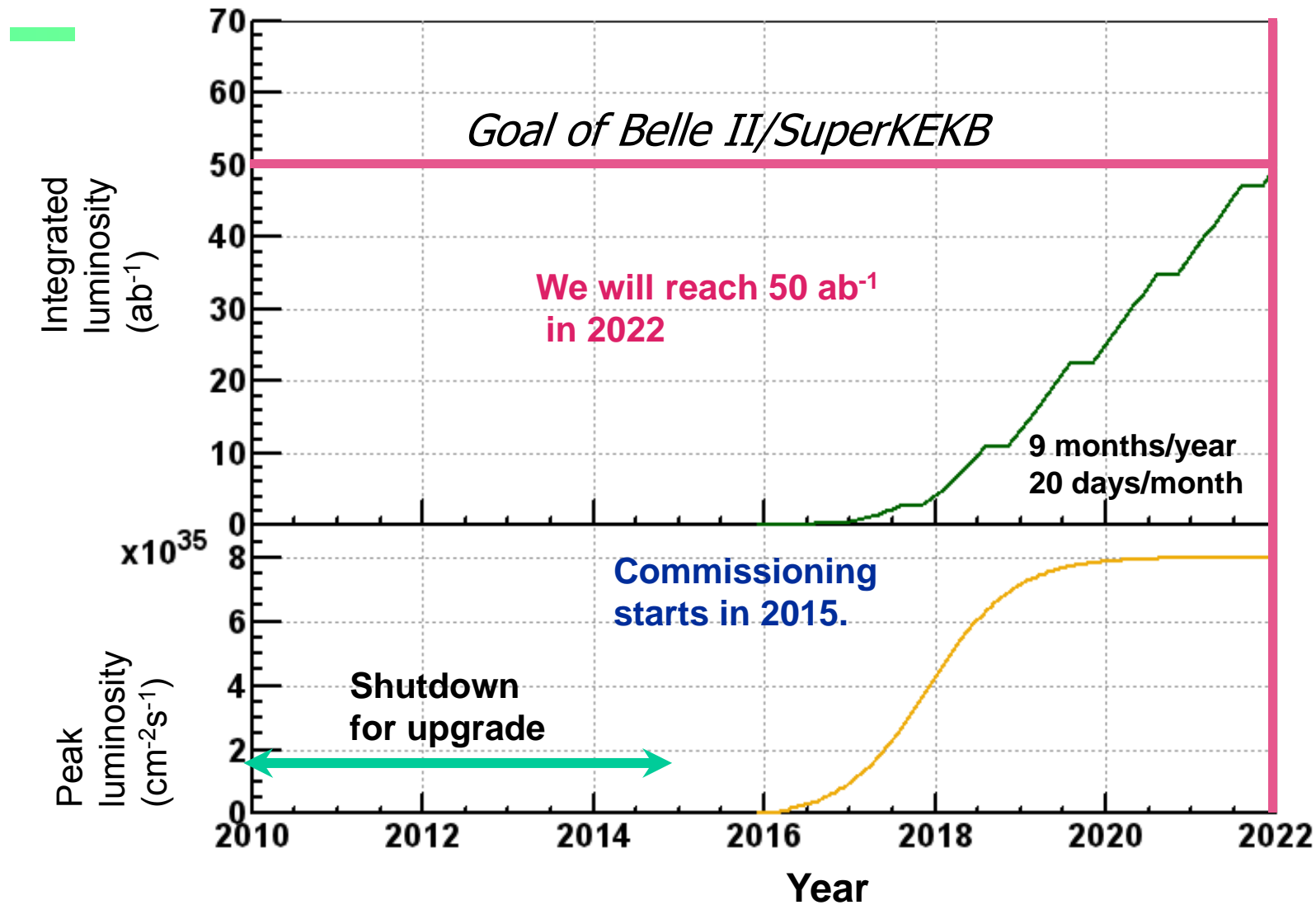

The schedule is likely to shift by a few months because of a new construction/commissioning strategy for the final quads.

The competition: LHCb

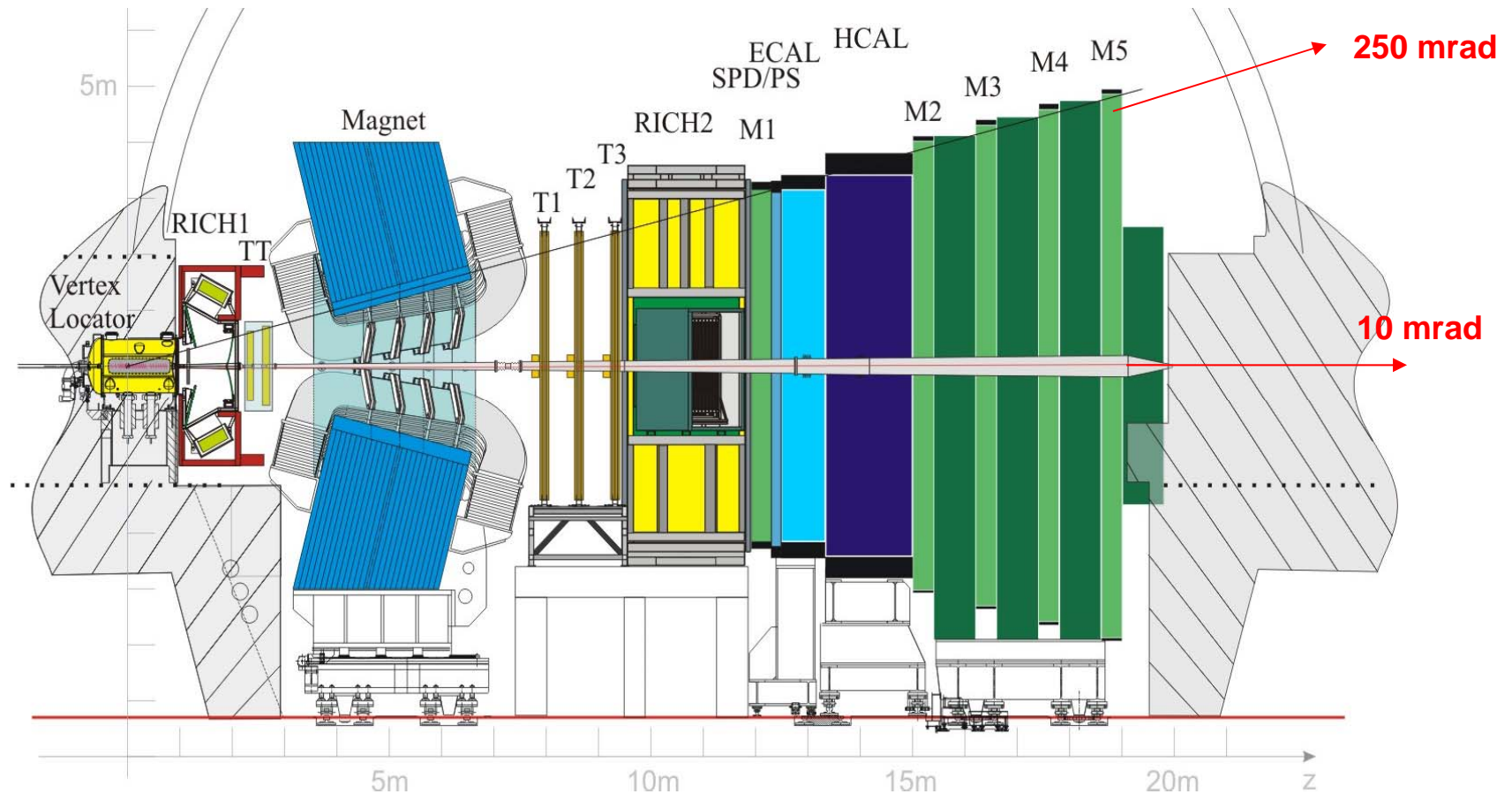

Vertex reconstruction:
VELO

Trigger:
Muon Chambers
Calorimeters
Tracker

PID:
RICHes
Calorimeters
Muon Chambers

Kinematics:
Magnet
Tracker
Calorimeters

The LHCb RICH counters

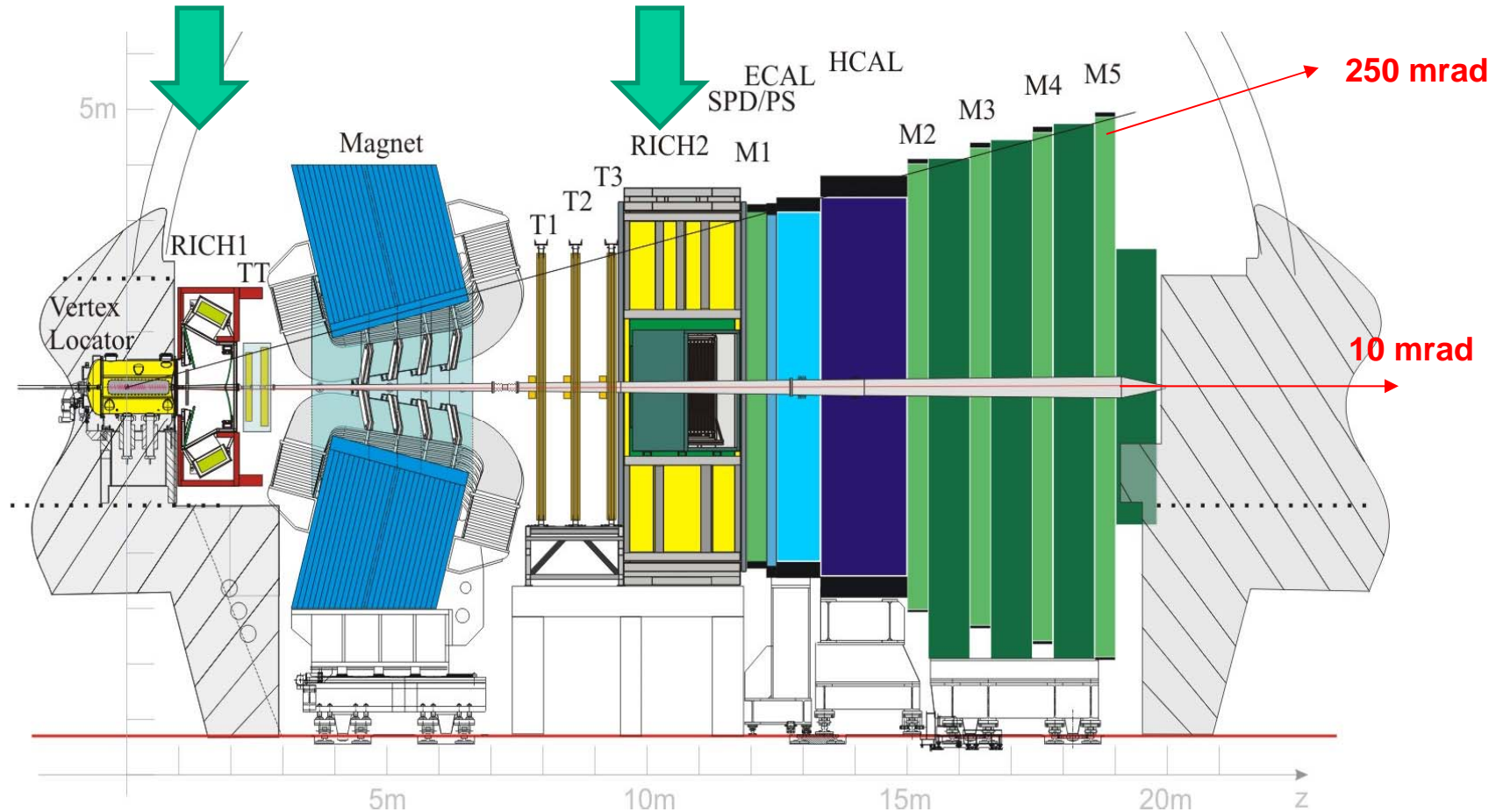

Vertex reconstruction:
VELO

Trigger:
Muon Chambers
Calorimeters
Tracker

PID:
RICHes
Calorimeters
Muon Chambers

Kinematics:
Magnet
Tracker
Calorimeters

LHCb RICHes

Need:

- Particle identification for momentum range $\sim 2\text{-}100\text{ GeV}/c$
- Granularity $2.5 \times 2.5\text{ mm}^2$
- Large area (2.8 m^2) with high active area fraction
- Fast compared to the 25ns bunch crossing time
- Have to operate in a small B field

→ 3 radiators

- Aerogel
- C_4F_{10}
- CF_4

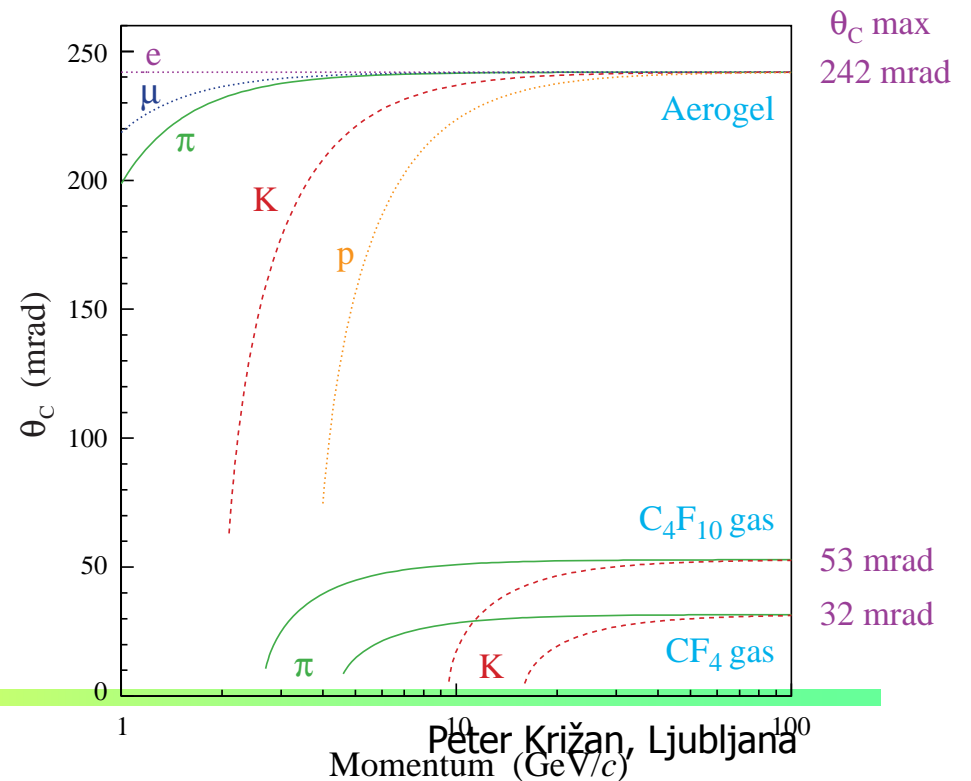

LHCb RICHes

Photon detector: hybrid PMT (R+D with DEP) with 5x demagnification (electrostatic focusing).

Hybrid PMT: accelerate photoelectrons in electric field ($\sim 20\text{kV}$), detect it in a pixelated silicon detector.

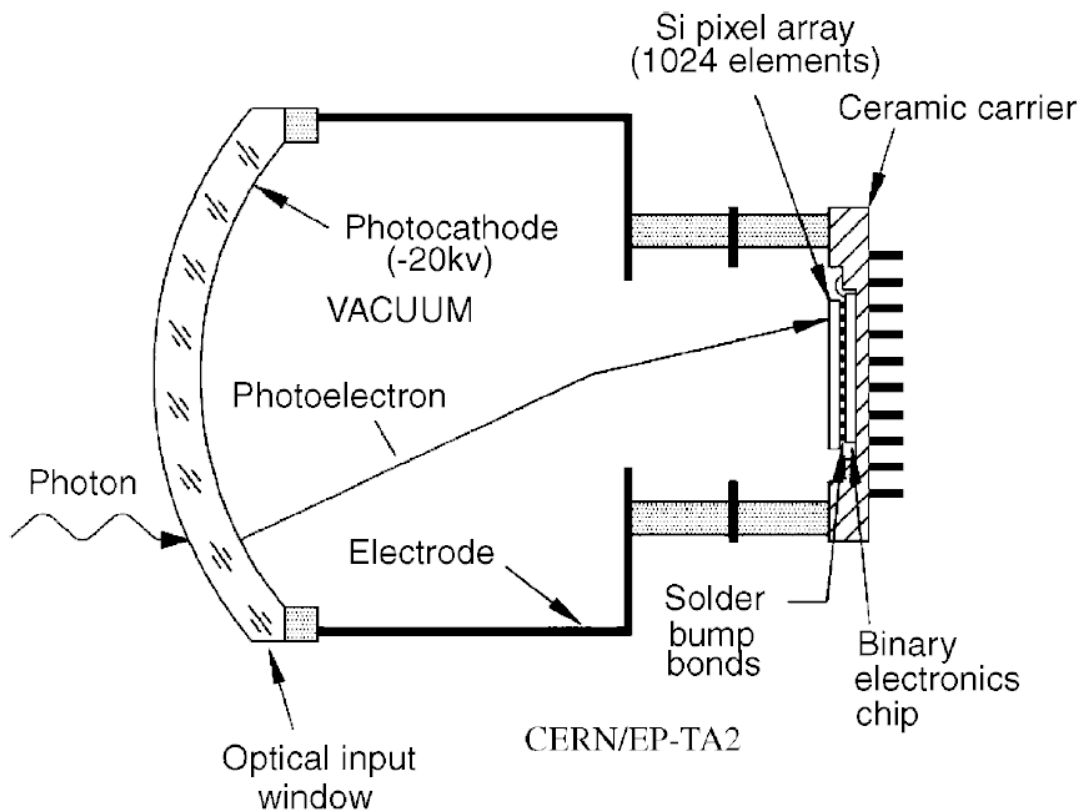

NIM A553 (2005) 333

LHCb RICHes: performance

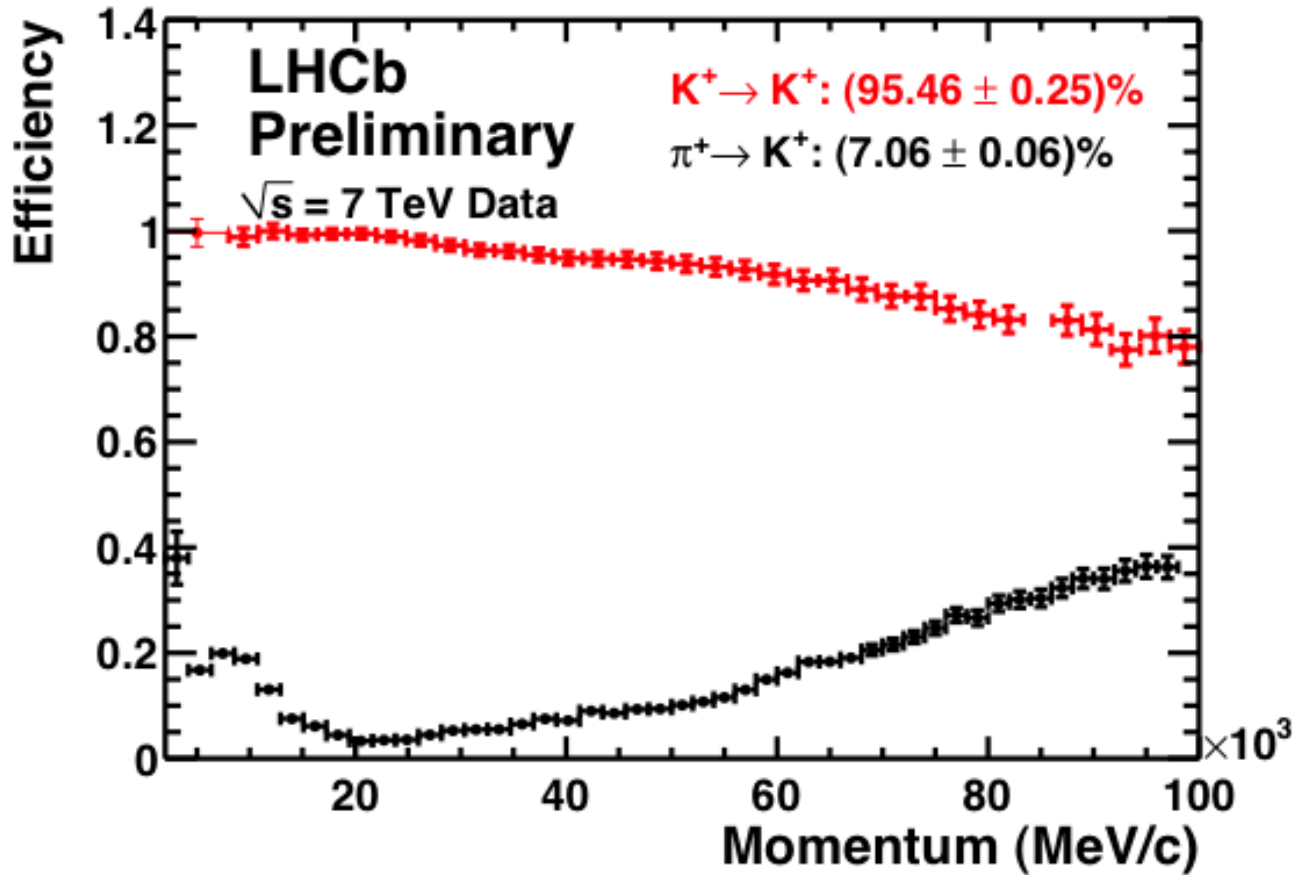

Efficiency and purity from data → excellent agreement with MC

N. Harnew, Beauty 2011

Pe

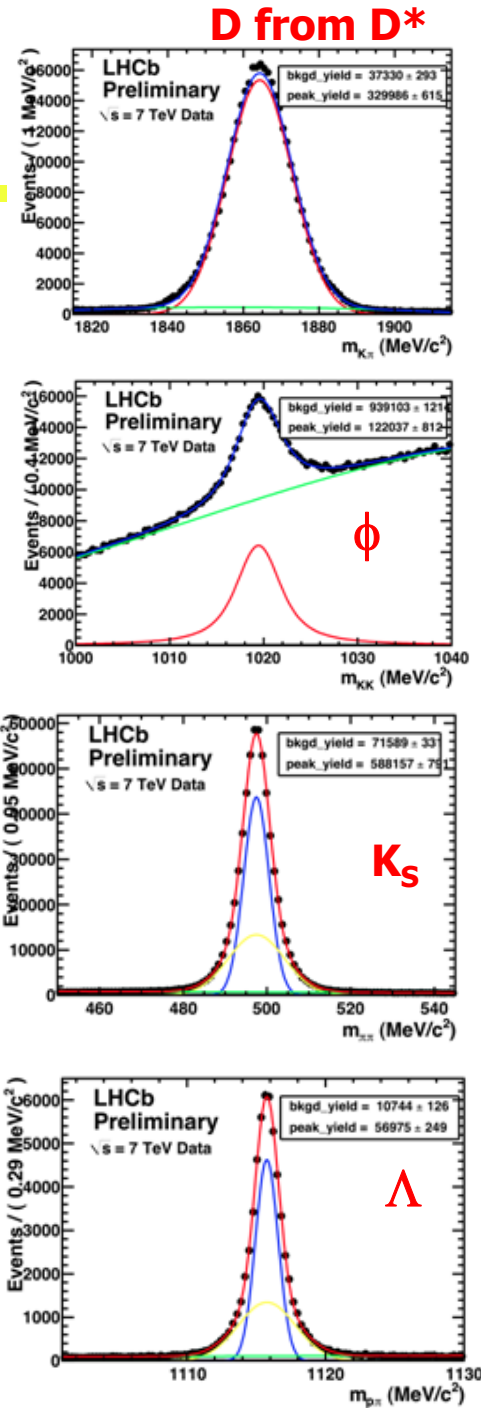

LHCb PID upgrade: TORCH

A special type of Time-of-Propagation counter for the LHCb upgrade

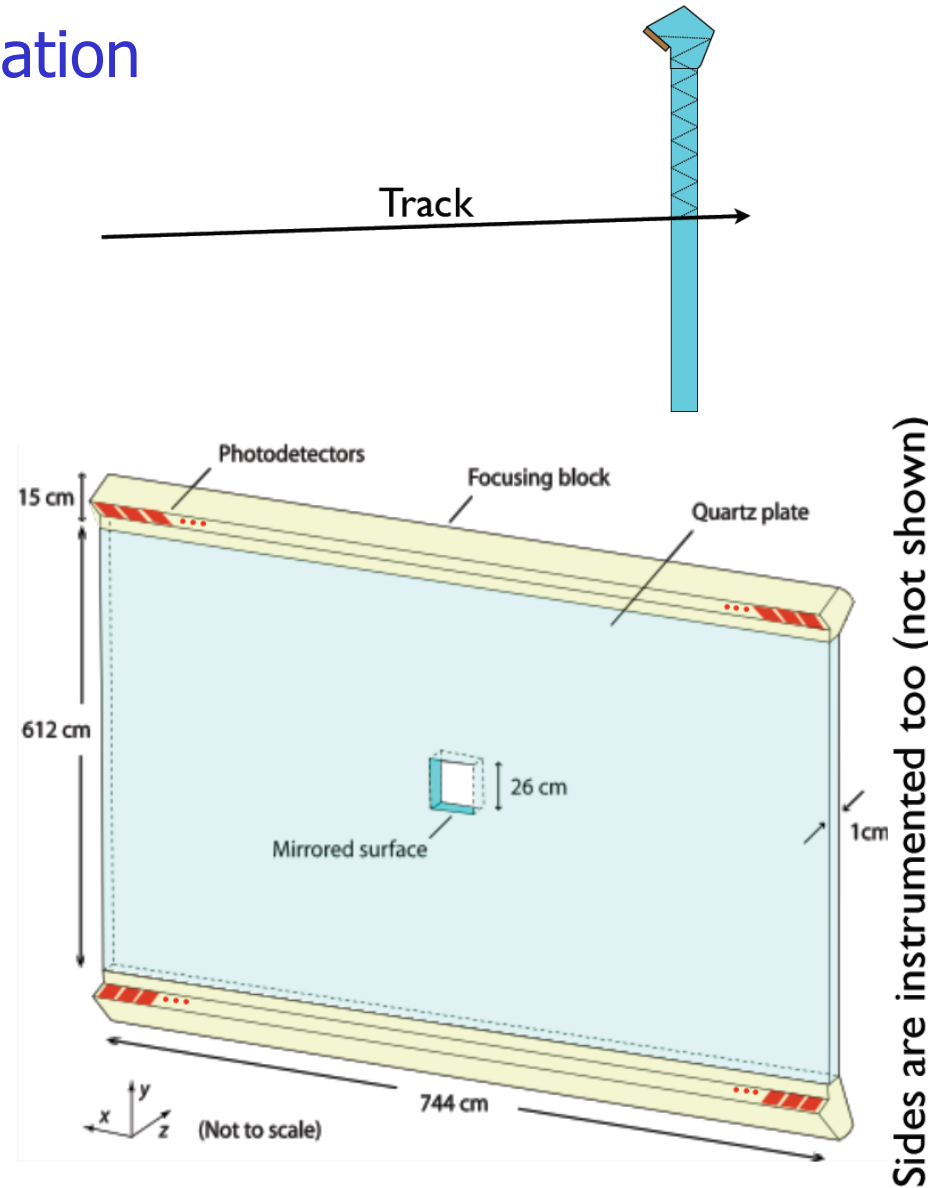
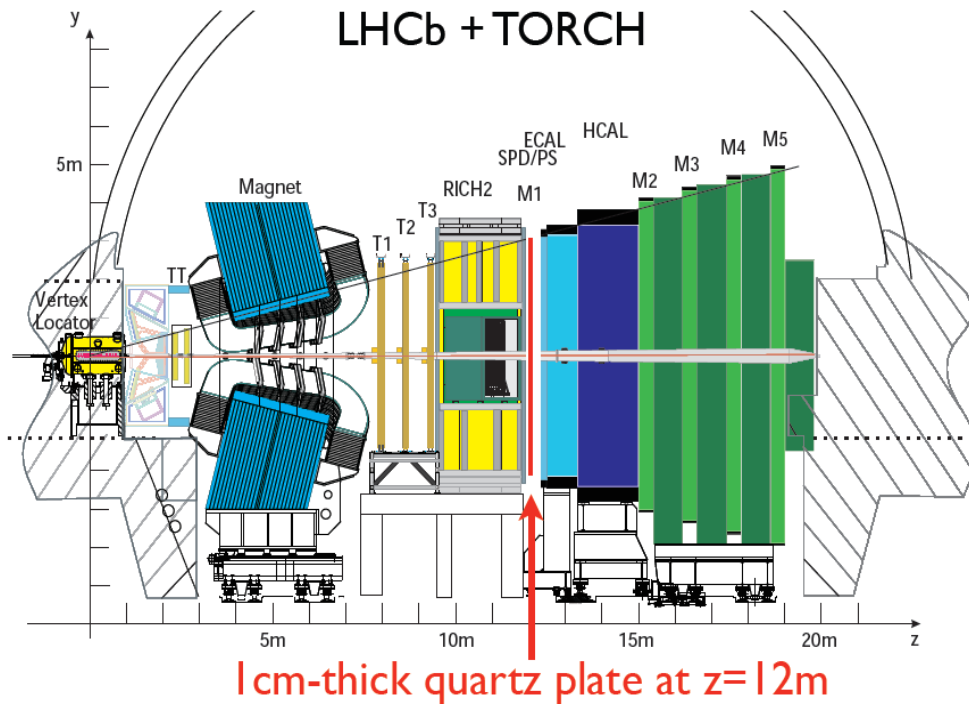

LHCb PID upgrade: TORCH

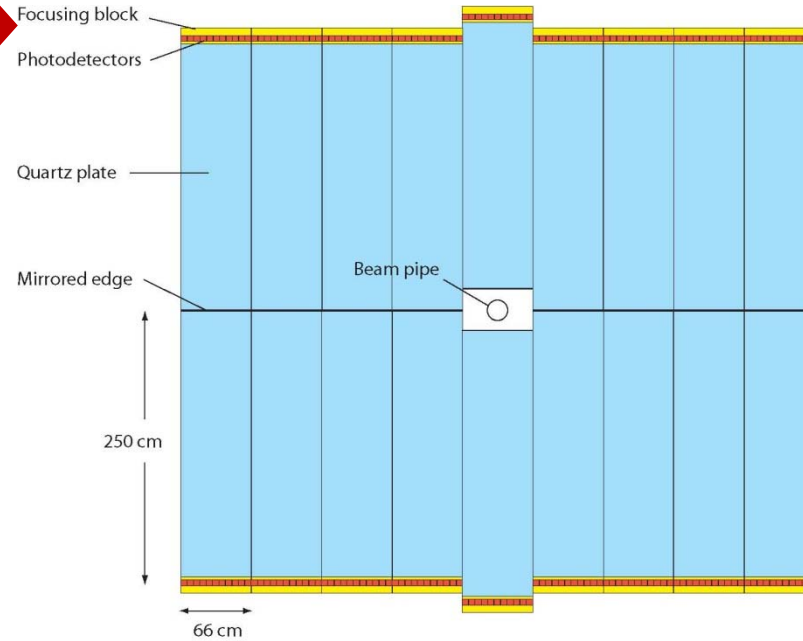
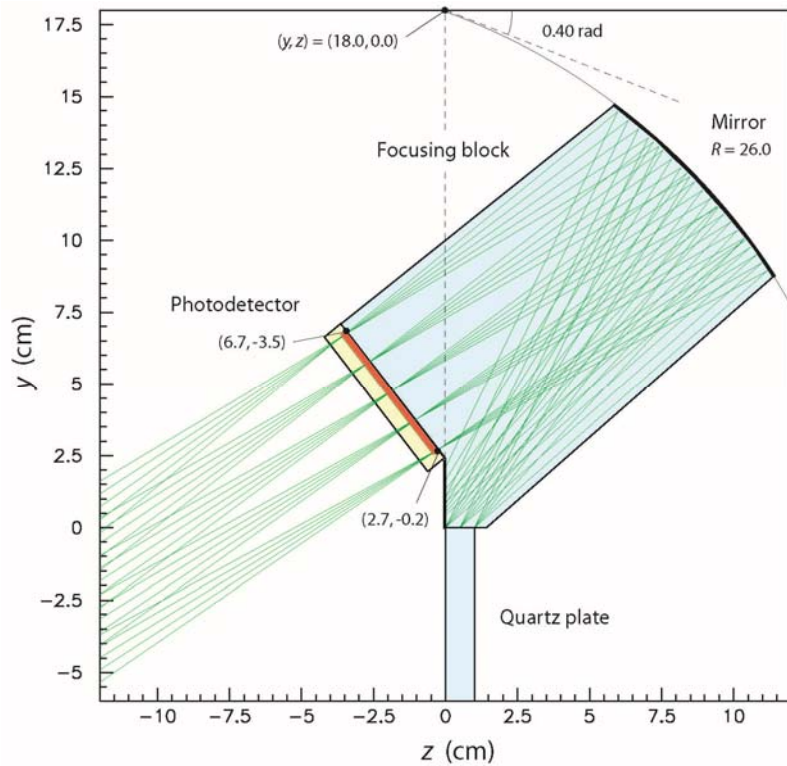

Expected performance with Photonis
Planacon MCP PMTs

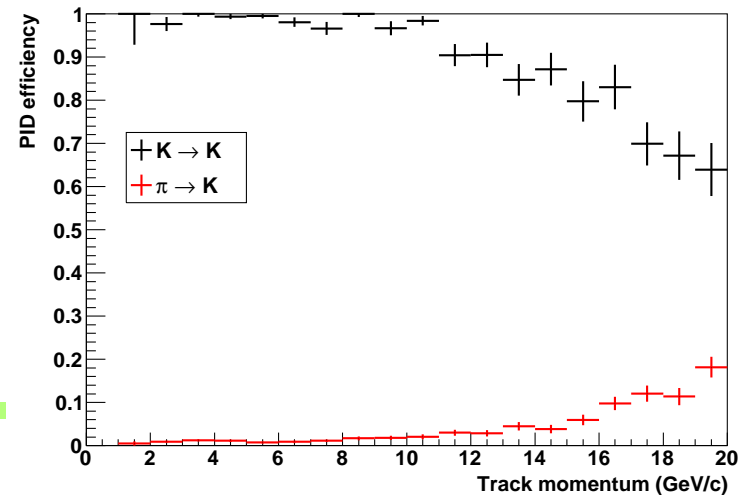



Conclusion



- KEKB has proven to be an excellent tool for flavour physics, with **reliable long term** operation, breaking world records, and **surpassing** its design performance by a factor of two.
- Major upgrade at KEK in 2010-15 → SuperKEKB+Belle II, with **40x larger** event rates, **construction well under way**
- Expect a new, exciting **era of discoveries**, complementary to the LHC

- There is still a lot of work to be done – if you are interested, join us!