

Medicinska fizika: znanost in poklic

Ervin B. Podgorsak

McGillova univerza
Montréal, Kanada

MEDICAL PHYSICS

- ❑ Branch of physics concerned with the applications of physics to medicine.
- ❑ Mainly, but not exclusively, related to use of ionizing radiation in:
 - Diagnosis of disease
 - Diagnostic Radiology** and **Nuclear Medicine**
 - Treatment of disease
 - Radiotherapy** (Radiation Oncology, Therapeutic Radiology)

Use of ionizing radiation in medicine

- The study and use of ionizing radiation in medicine started with three important discoveries:
 - X-rays by **Wilhelm Roentgen** in 1895.
 - Natural radioactivity by **Henri Becquerel** in 1896.
 - Radium-226 by **Pierre Curie** and **Maria Sklodowska** in 1898.



Role of ionizing radiation

□ **Ionizing radiation** is playing important role in:

- Atomic, nuclear, and particle physics.
- Medicine providing impetus for development of **radiology**, **nuclear medicine**, and **radiotherapy** as medical specialties and **medical physics** as a specialty of physics.
- **Industry** offering many **non-destructive measurement techniques** and special techniques used in **evaluation of oil fields**.
- **Agriculture** providing **food sterilization** and **pest control**.

"X rays will prove to be a hoax"

William Thomson

Lord Kelvin

(1824 - 1907)

who had been appointed a professor of mathematics and physics at the age of 22 and who became one of the greatest scientist of his day.

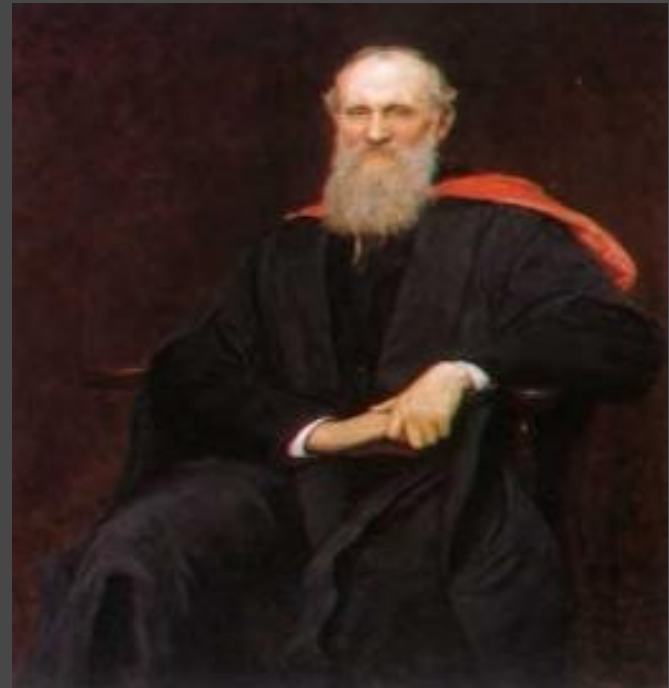

Depth doses for ionizing radiation

Indirectly ionizing radiation

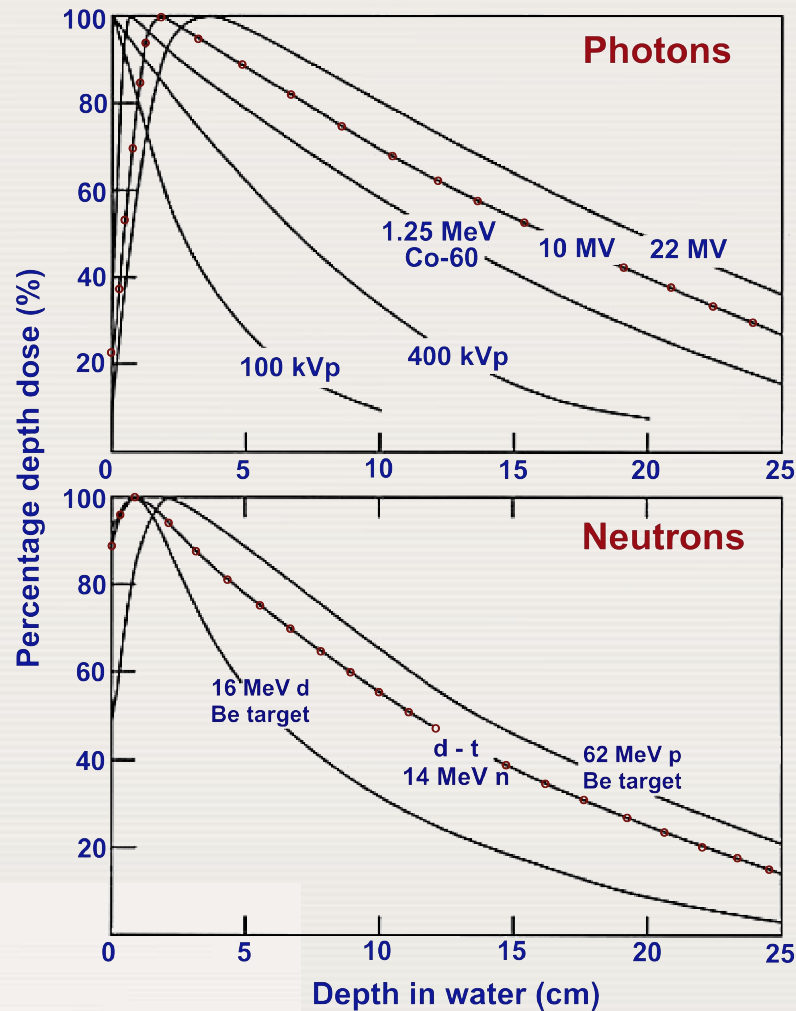

Directly ionizing radiation

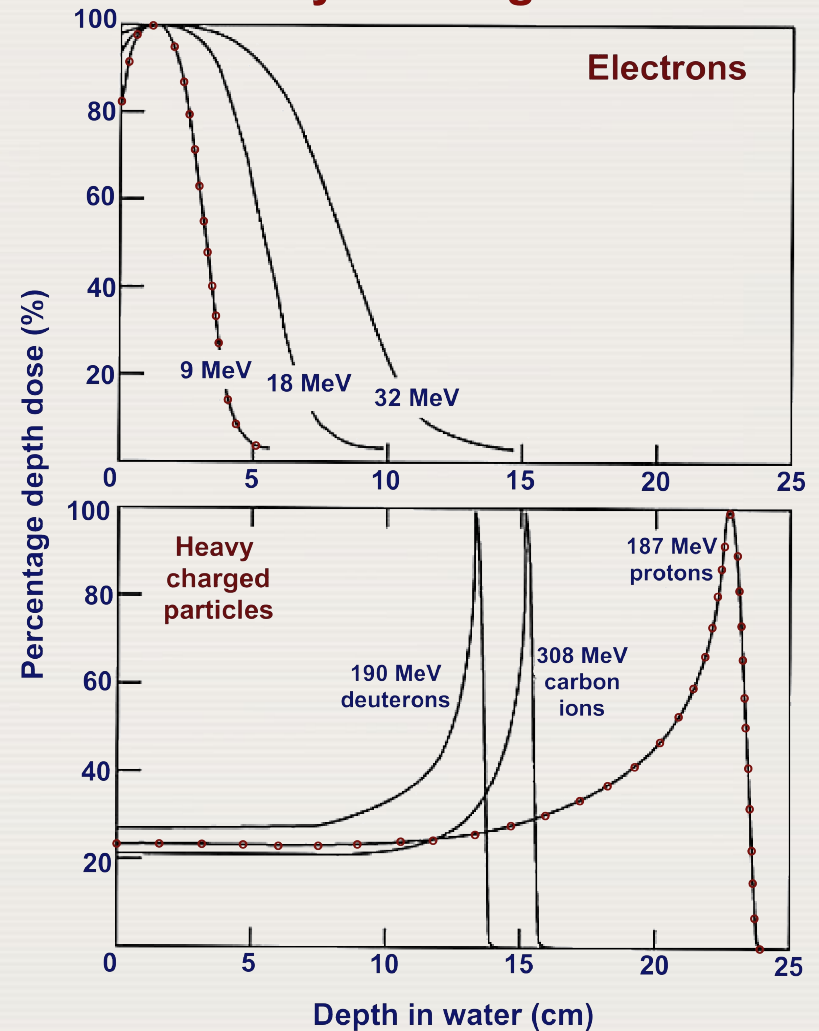

Incidence and Death Rates for selected cancer sites: Males in Canada, 1972-2003

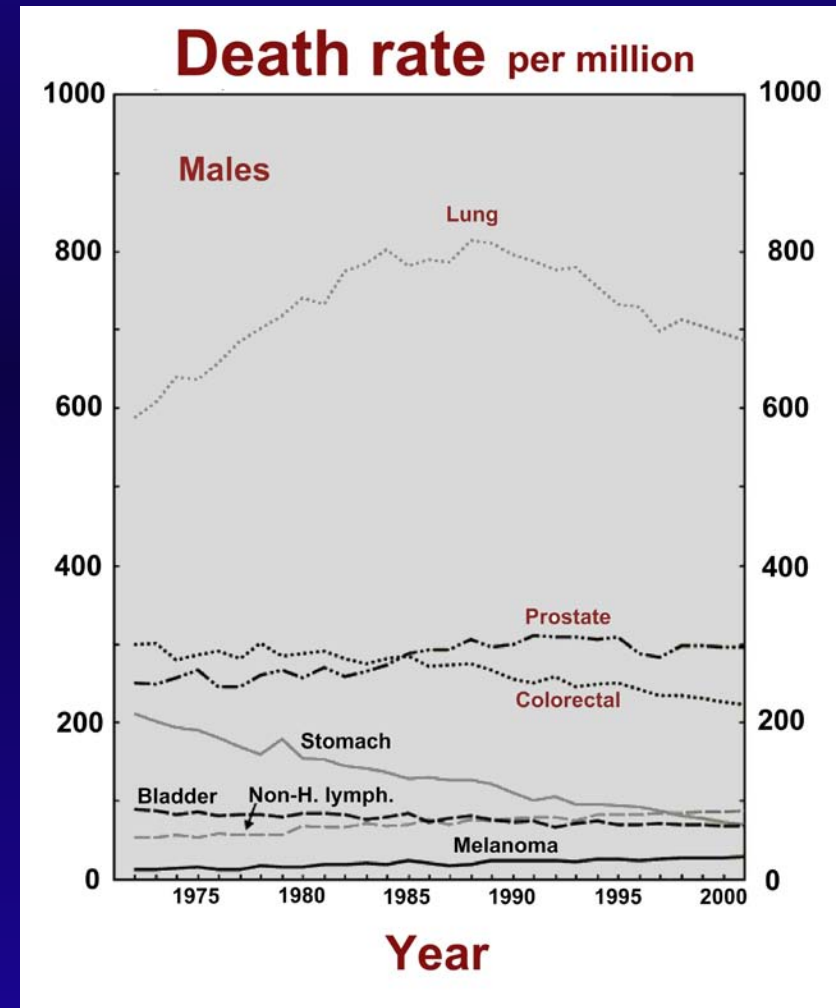
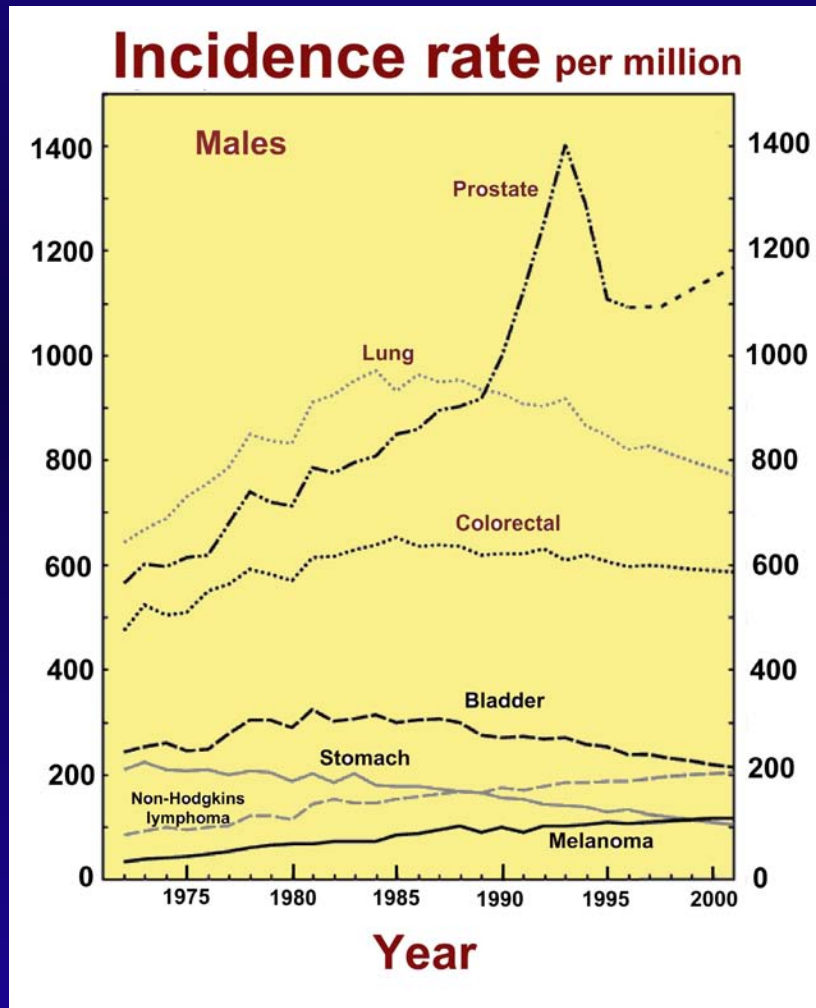

Incidence and Death Rates for selected cancer sites: Females in Canada, 1972-2001

Incidence rate per million

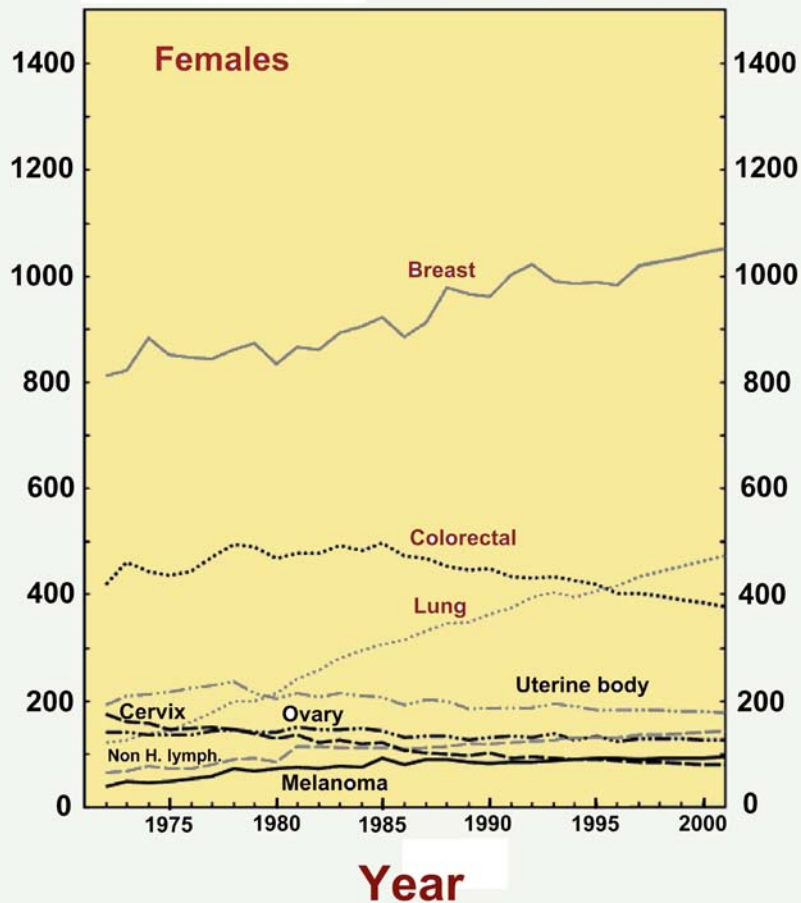

Death rate per million

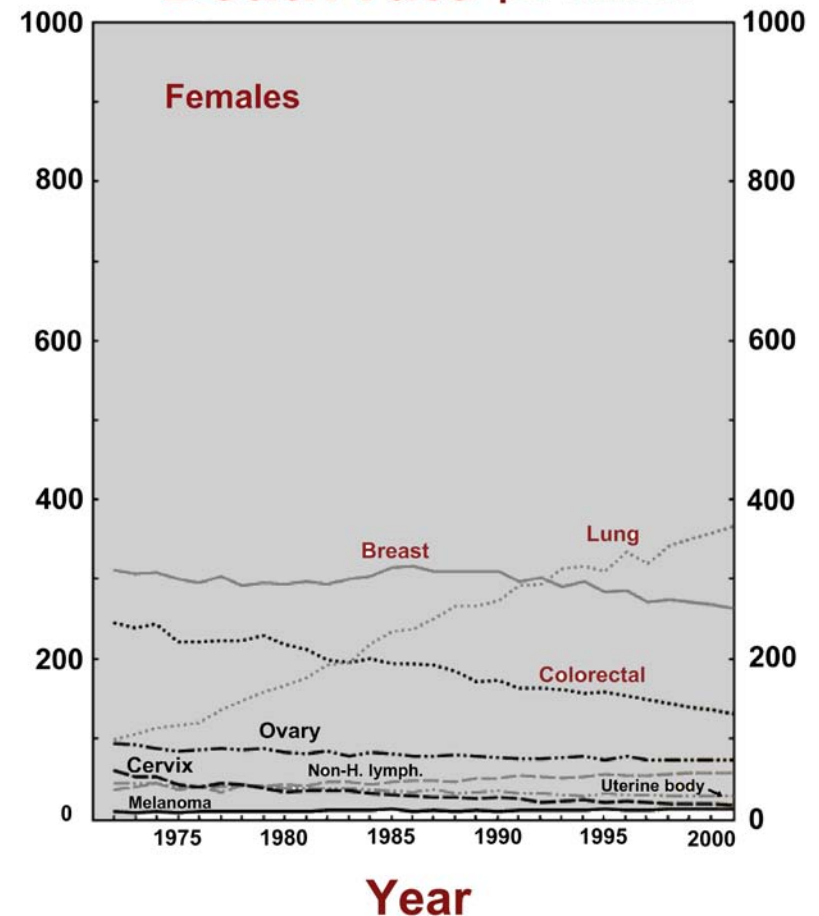

Cancer incidence

- ❑ **4300 per million population** (in developed world) per year.
- ❑ **1 in 230 people** (in developed world) per year.
- ❑ Incidence rate is increasing at **3% per year**.
- ❑ World cancer rate: about 10 million per year.
- ❑ In developing countries the cancer rate is lower:
 - Because of less developed health care service.
 - Because of lower life expectancy.

CANCER THERAPY

- **Surgery** (elimination of a tumor in a well-defined volume of tissue)
- **Radiotherapy**
(elimination of a tumor in a well-defined volume of tissue)
- **Chemotherapy** (cell-destroying drugs)
- **Hyperthermia** (application of heat)
- **Immunotherapy**
(mobilization of the body's natural resistance to foreign cells)

GOALS of MODERN RADIOTHERAPY

- **To improve tumor control**

through an increase in tumor dose,
i.e., through an increase in TCP

- **To reduce morbidity**

through decreased dose to normal tissue,
i.e., through a decrease in NTCP

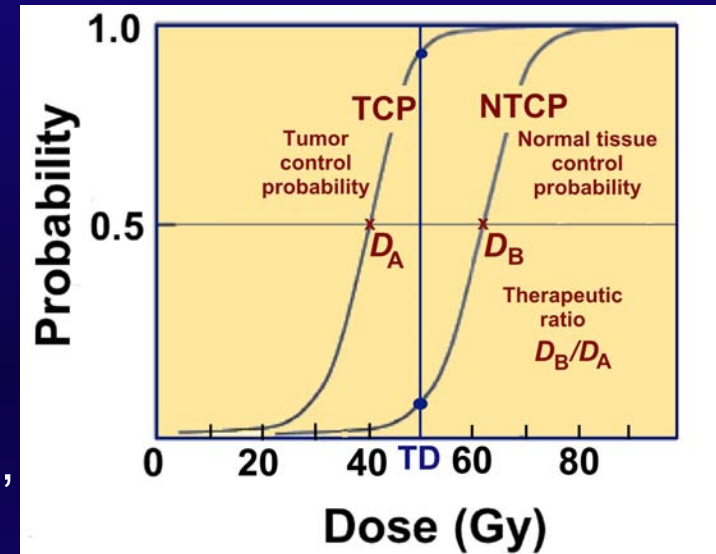

Using { (1) **More complex treatment techniques**
and
(2) **New technology**

The quandary of radiotherapy

Radiotherapy:

Use of invisible radiation to treat invisible target and spare invisible organs-at-risk.

Quote from **William Powers, M.D.**

- ❑ If you cannot see it, you cannot hit it,
- ❑ If you cannot hit it, you cannot cure it.

Imaging is an important and integral part of the radiotherapy process.

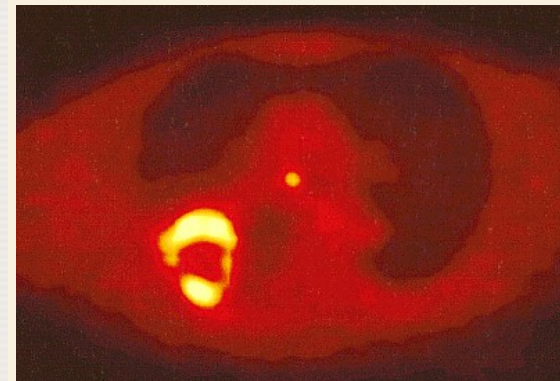
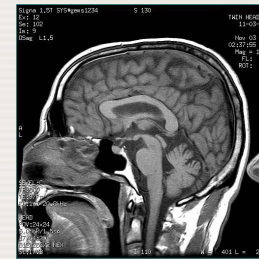
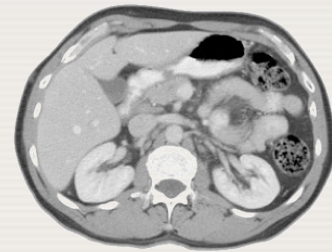
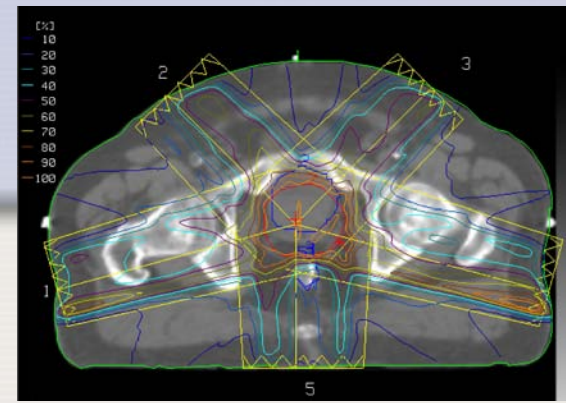

Modern radiotherapy process

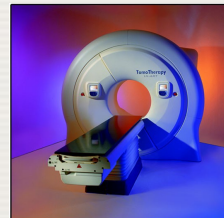
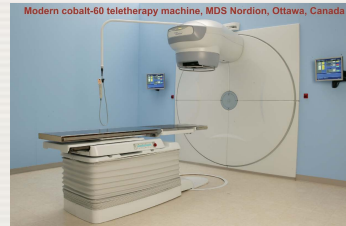
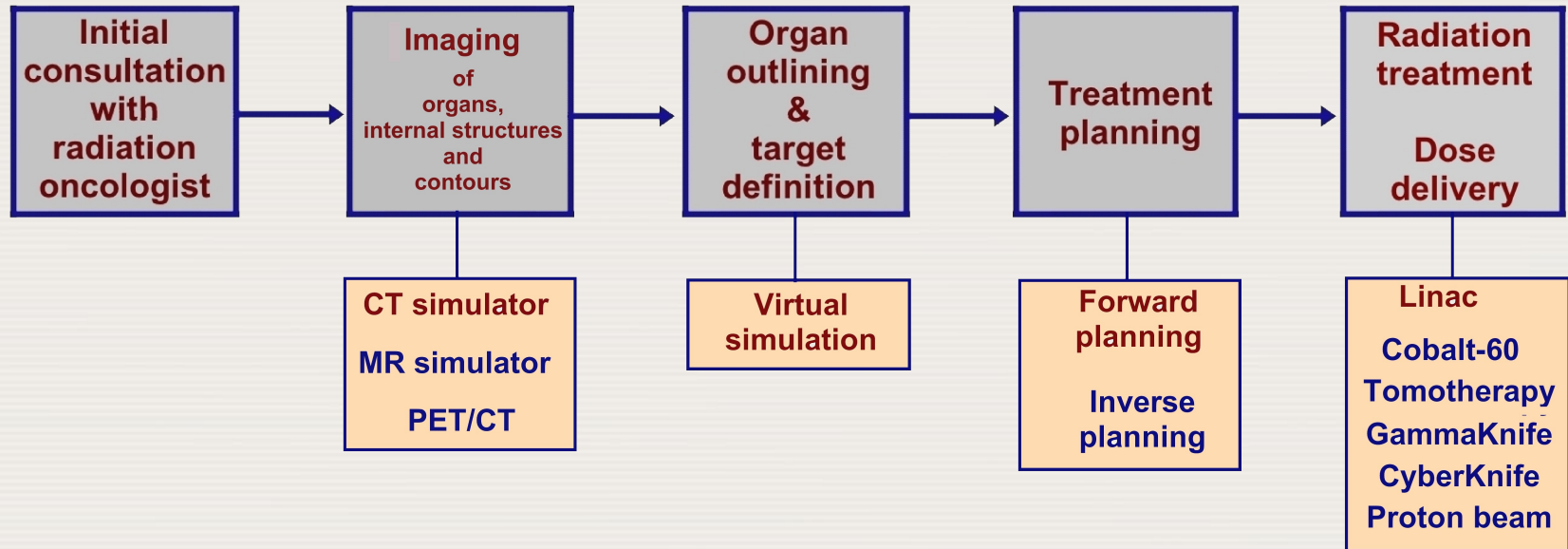

Modern radiotherapy process



X-RAY MACHINES

THEN (1920)

NOW

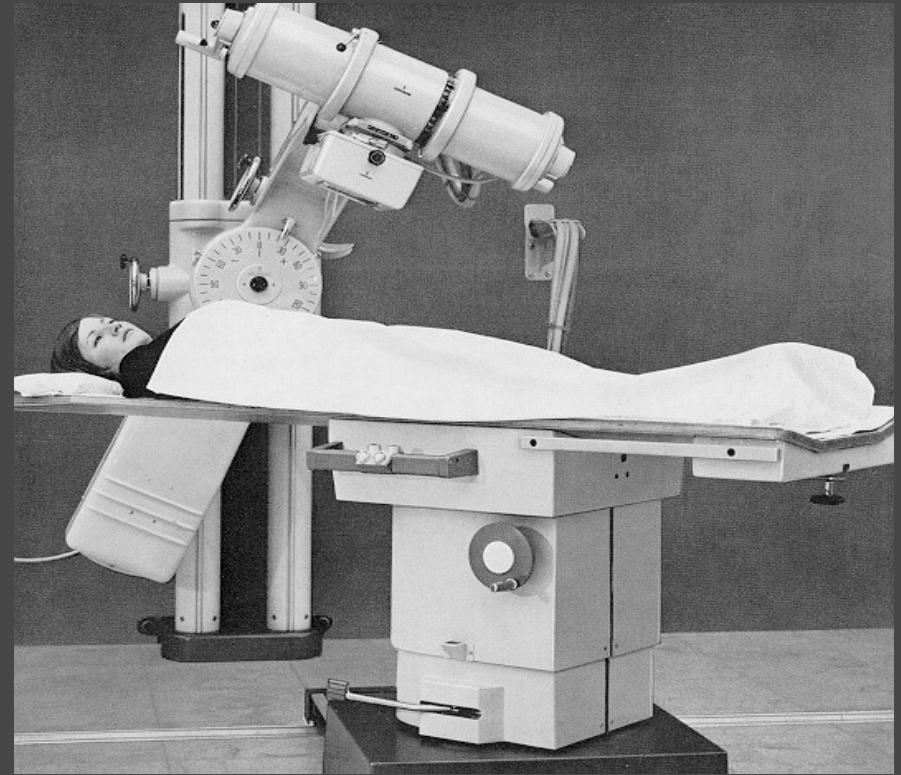
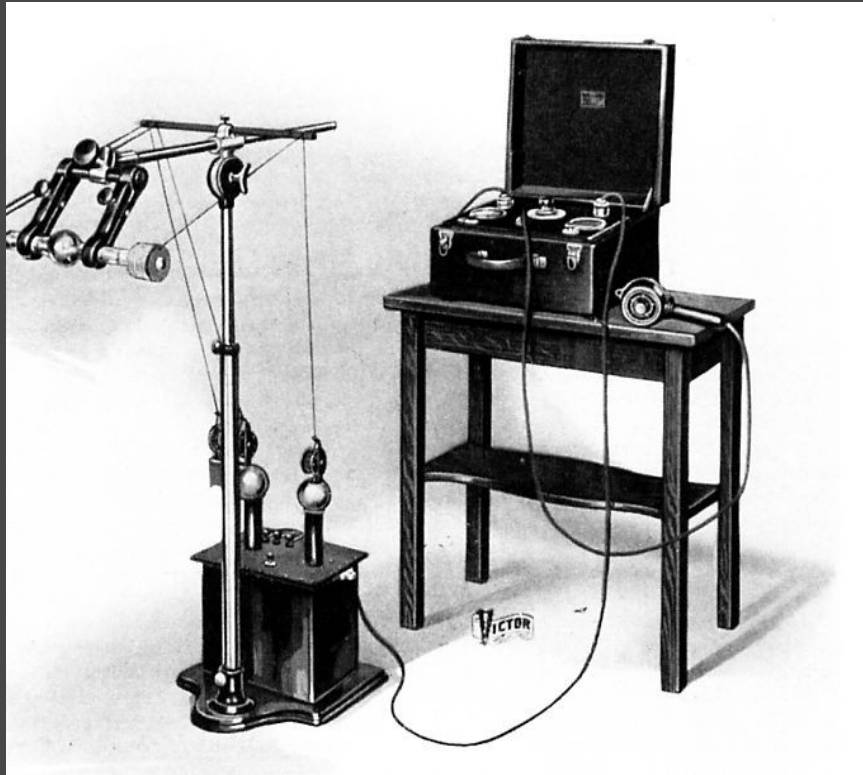

Crookes “cold cathode” x-ray tube

□ **Roentgen** discovered x rays in 1895 while experimenting with a **Crookes “cold cathode” tube**.

- Crookes tube is a sealed glass cylinder with two embedded electrodes operated with **rarefied gas**.
- The potential between the two electrodes produces discharge in the rarefied gas causing ionization of gas molecules.
- Electrons (cathode rays) are accelerated toward the positive electrode producing x rays upon striking it.

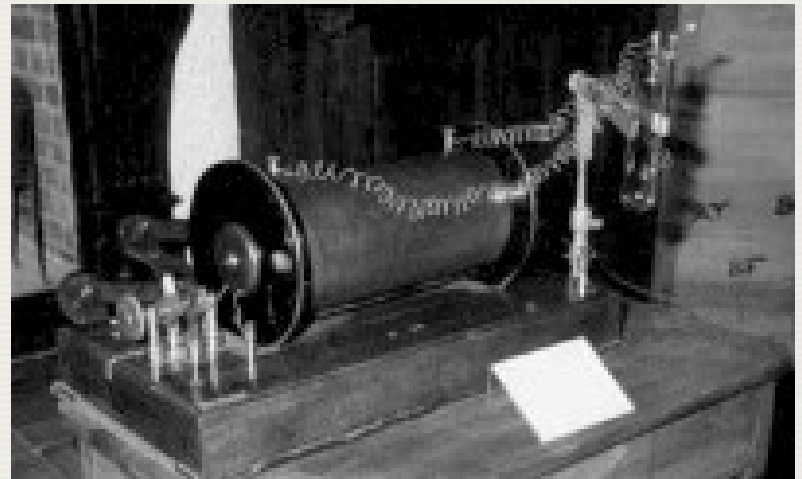

Photograph of Roentgen's apparatus

Coolidge “hot cathode” x-ray tube

□ **Coolidge** in 1913 designed a “hot cathode” x-ray tube and his design is still in use today.

- The main characteristics of the Coolidge tube are its high vacuum and its use of heated filament (cathode).
- The heated filament emits electrons through thermionic emission.
- X-rays are produced in the target (anode) through radiation losses of electrons producing characteristic photons and bremsstrahlung photons.

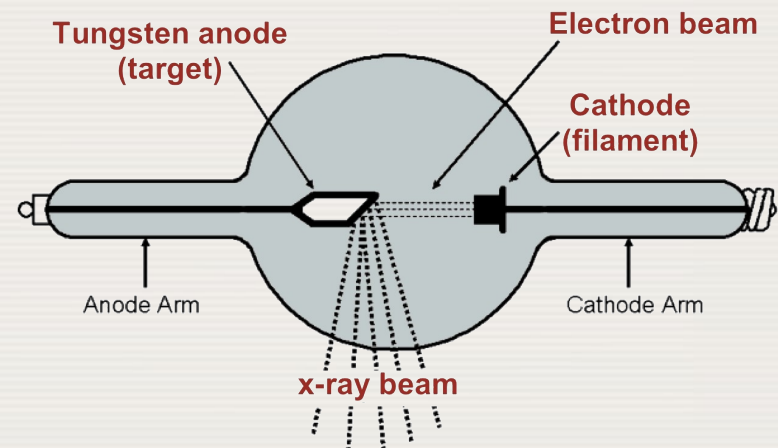

Diagnostic x-ray imaging

Then

Now



Imaging for target localization

□ 1970s CT scanner

Allan Cormack

Godfrey Hounsfield

Nobel Prize 1979



□ 1973 PET scanner

Edward J. Hoffman

Michael E. Phelps



□ 1980s MR scanner

Paul C. Lauterbur

Peter Mansfield

Nobel Prize 2003



Imaging for target localization - CT scanner

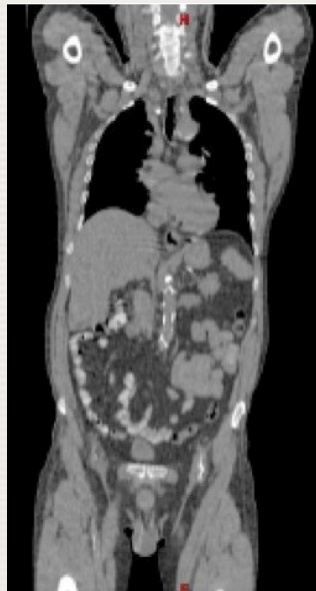
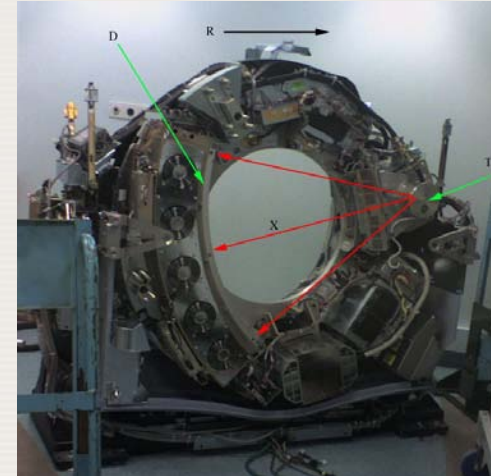
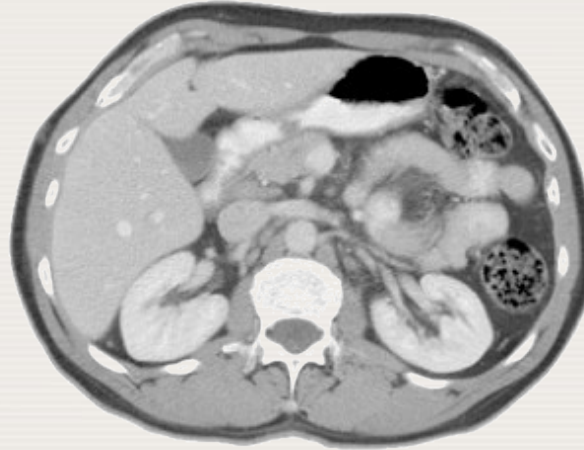
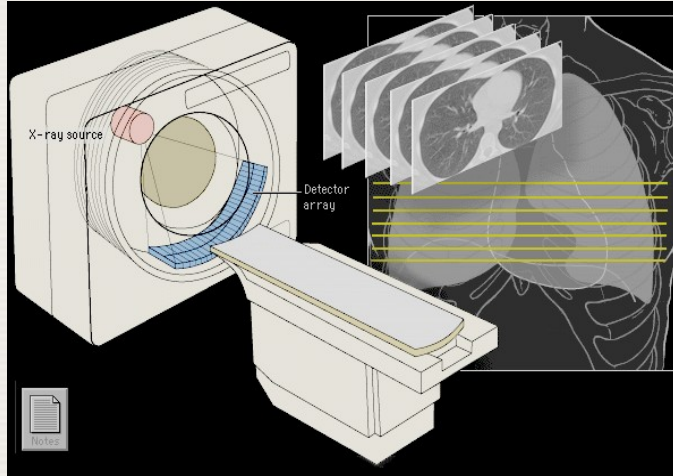

CT number in Hounsfield units

Each pixel is assigned a numerical value (CT number) representing the average of all attenuation values contained within the corresponding voxel.

The CT number is compared to the attenuation value of water and displayed on a scale of **Hounsfield units (HU)**:

$$HU = 1000 \times \frac{\mu - \mu_{\text{water}}}{\mu_{\text{water}}}$$

CT number in Hounsfield units

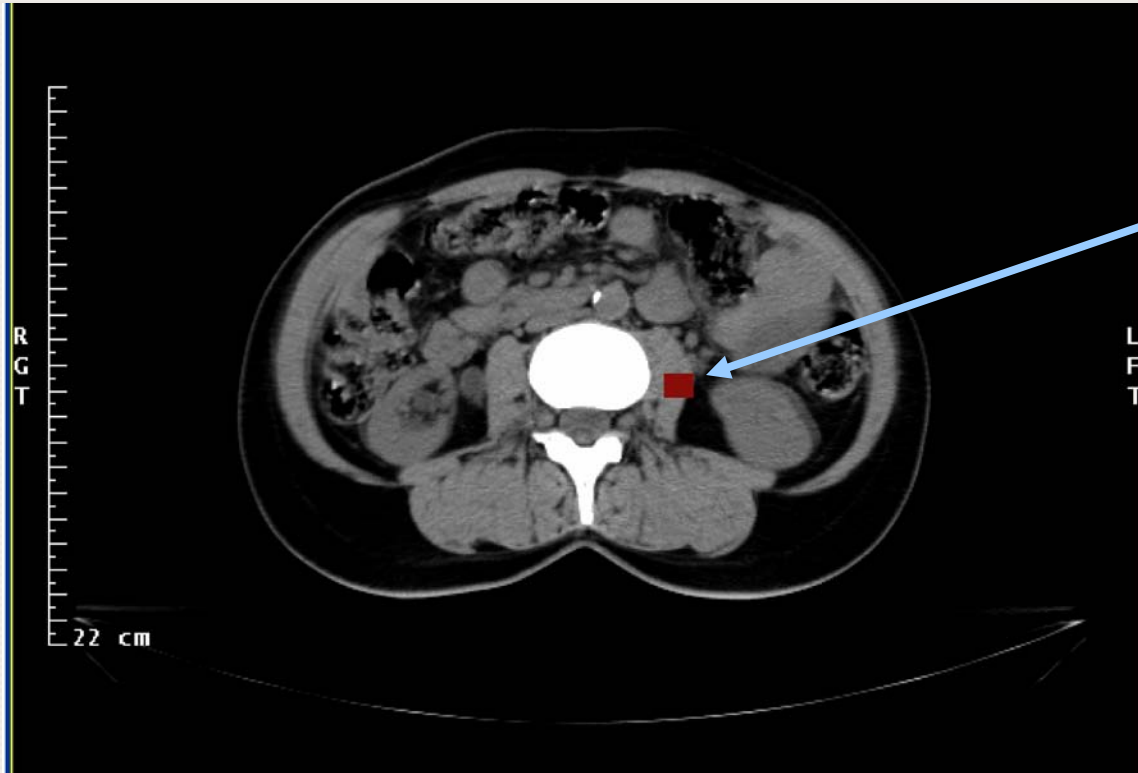

$\mu(\xi, \psi)$

$$HU = 1000 \times \frac{\mu - \mu_{\text{water}}}{\mu_{\text{water}}}$$

CT number in Hounsfield units

Each **Hounsfield number** represents a shade of grey ranging from **+1000 (bone) in white** to **-1000 in black (air - lung)**

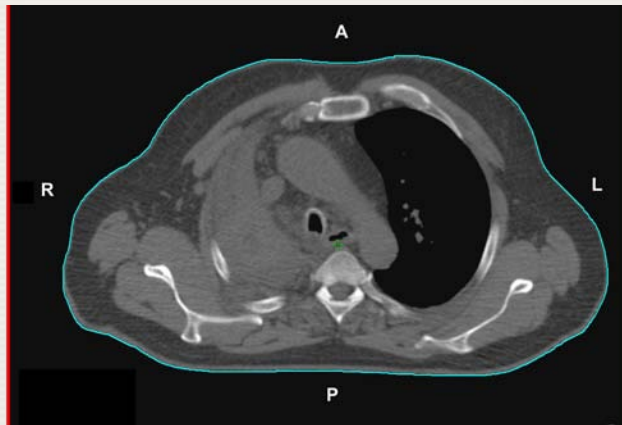
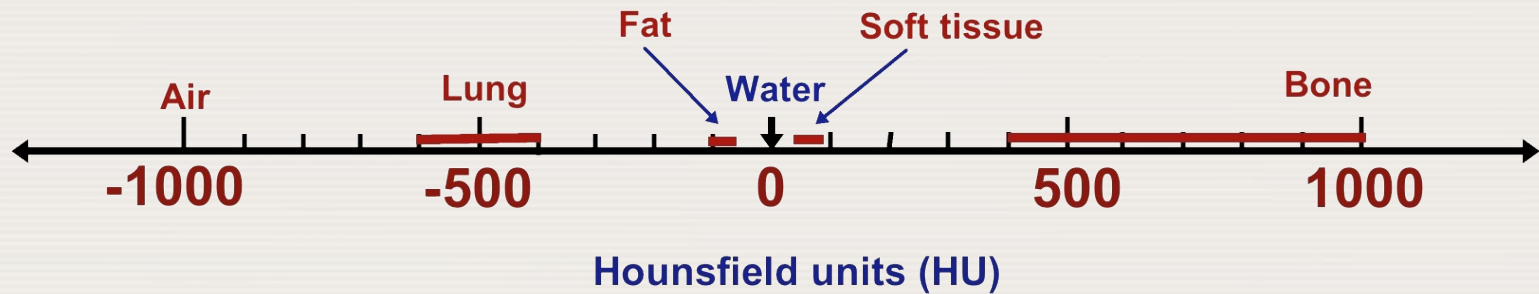

Bone: +400 to +1000
Tissue: +40 to +80
Water: 0
Fat: -60 to -100
Lung: -400 to -600
Air: -1000

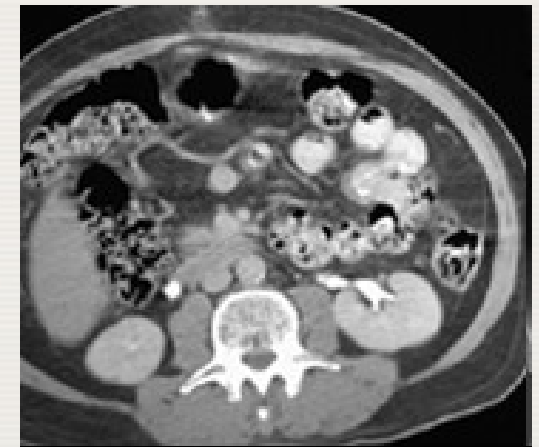

CT simulator

- **CT simulators** are CT scanners equipped with special features dedicated to the radiotherapy process, such as:
- **Flat table top** surface to provide a flat patient position during simulation that will be identical to the position during treatment on a megavoltage machine.
 - **Laser marking system** to transfer the coordinates of the tumor isocentre to the surface of the patient.
 - **Virtual simulator** to allow the user to define and calculate a treatment isocentre and then simulate a treatment using digitally reconstructed radiographs (DRRs).



CT simulator - Digitally Reconstructed Radiograph

- Digitally reconstructed radiograph (DRR) is the digital equivalent of a planar simulation x-ray film.
- DRR is reconstructed from a CT data set using virtual simulation software available on CT simulator or on TPS.

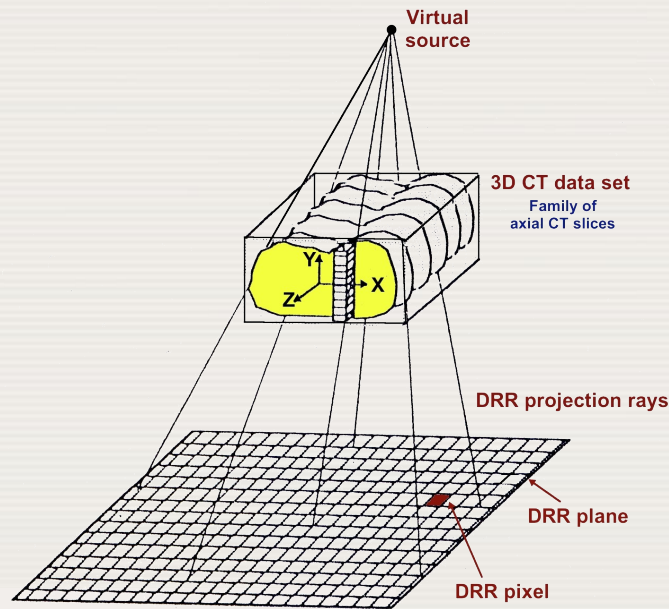

Imaging for target localization: **MRI scanner**



MRI SCANNER

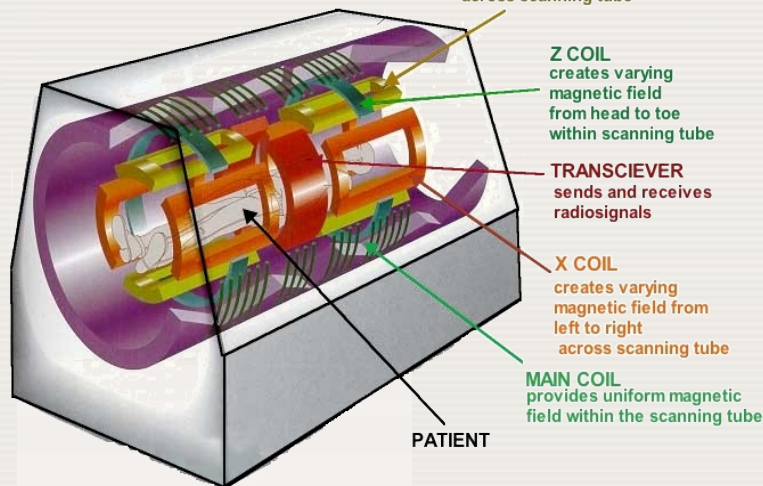

Main components of MR scanner:

- **Static magnetic field:** 0.3 T to 4.5 T permanent magnet; resistive electromagnet; superconducting electromagnet)
- (2) **RF transmitter and receiver**
- (3) **Three orthogonal, controllable magnetic gradients**

IMAGE FUSION (CO-REGISTRATION)

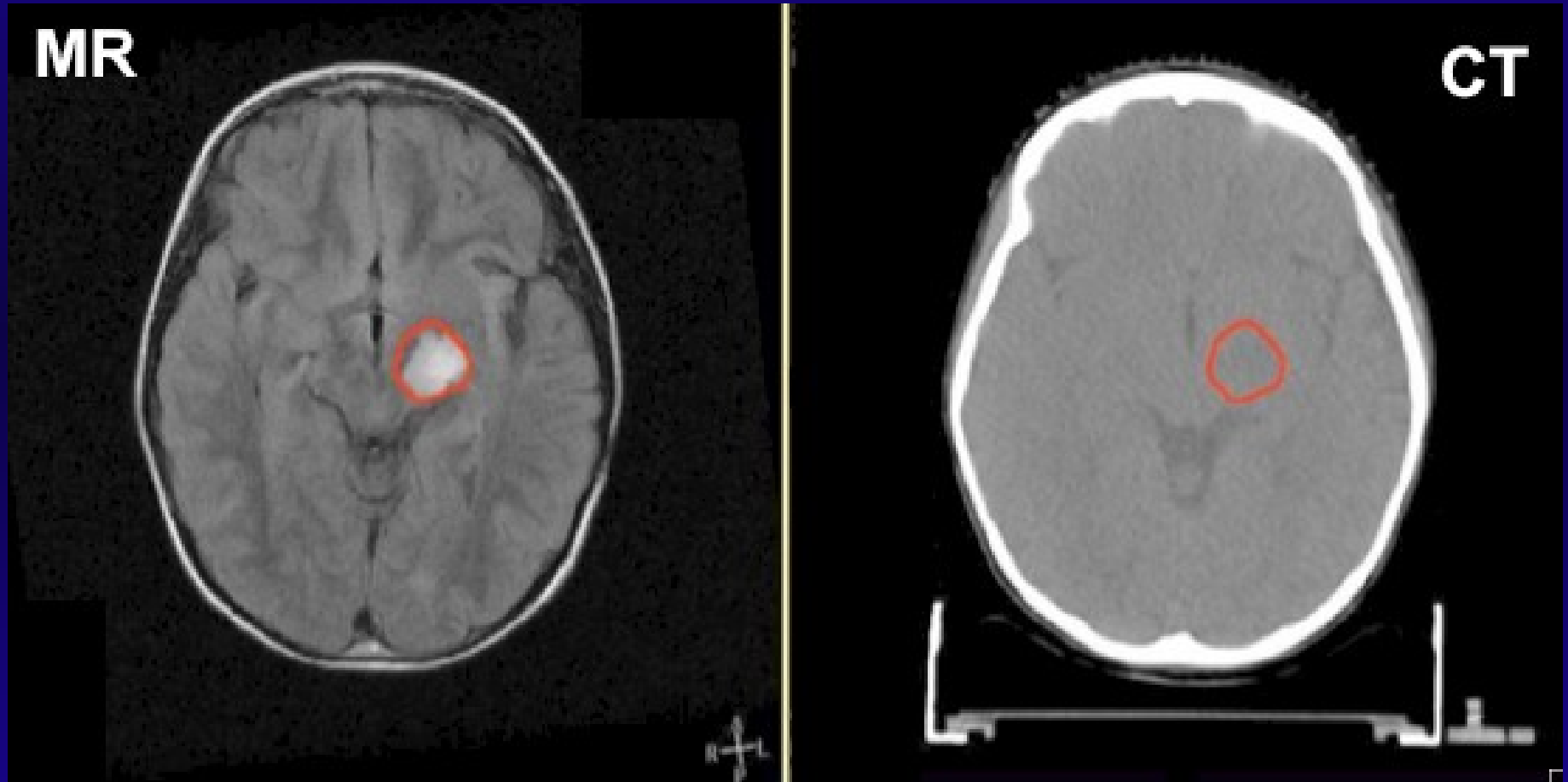
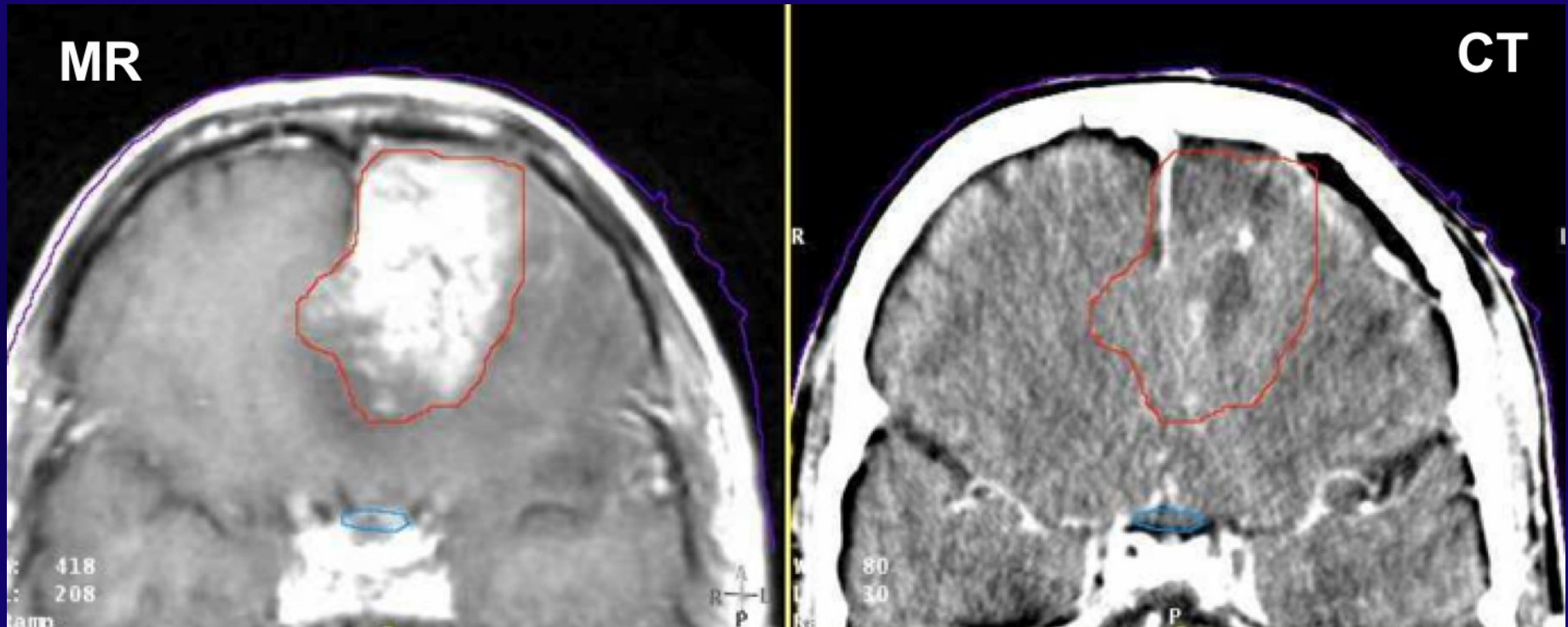
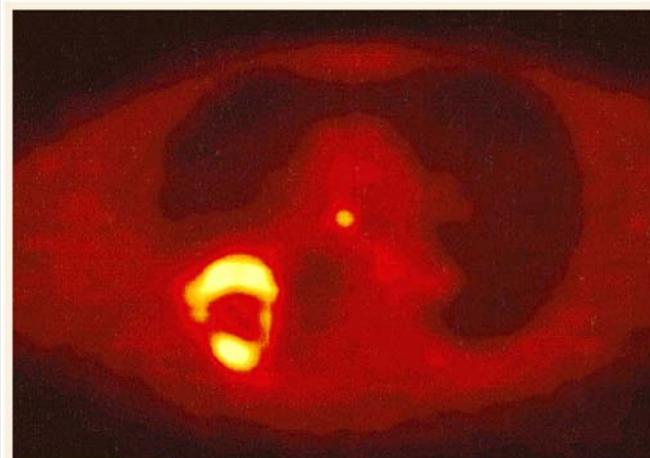
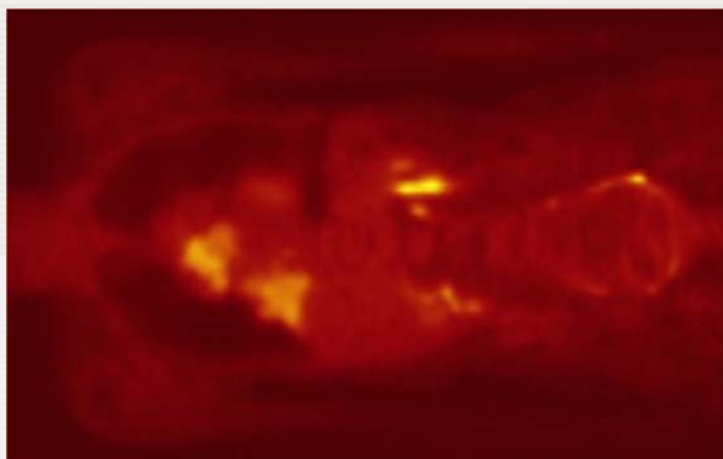
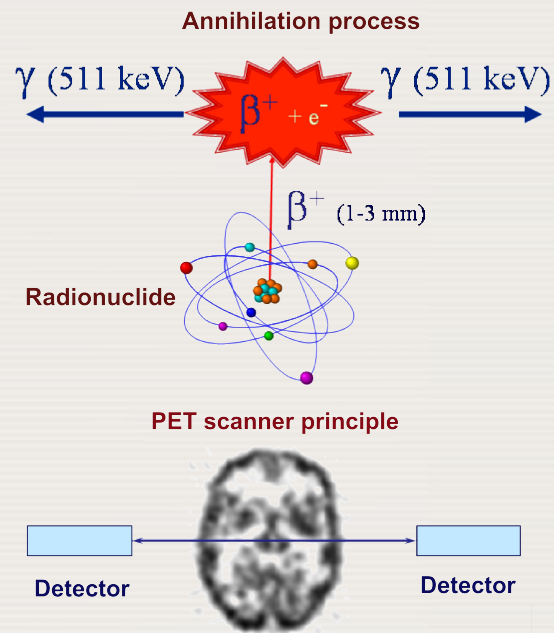
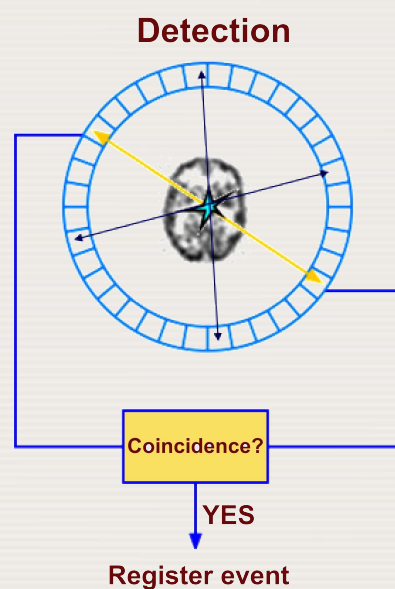

Image co-registration: MR and CT



Positron Emission Tomography (PET)



C-11 (20.5 min)
N-13 (10 min)
O-15 (2 min)

F-18 (110 min)
FDG: fluoro-deoxy-D-glucose

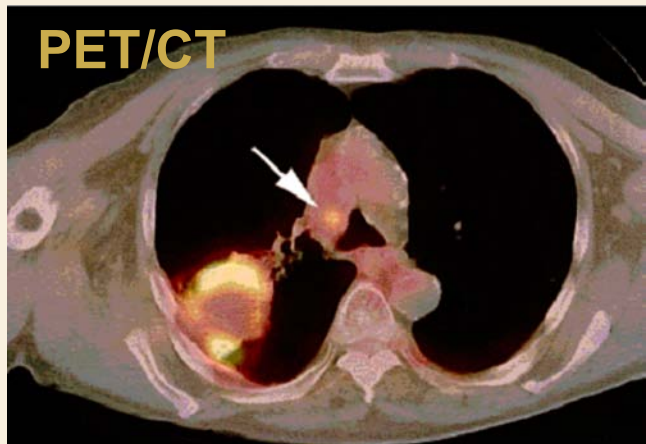
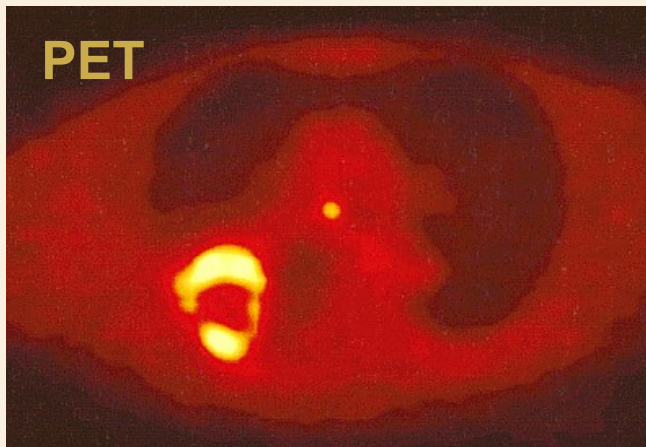

PET/CT co-registration (fusion)

- PET provides functional imaging
- CT provides anatomic imaging

PET/CT machine



Beyer, T.; Townsend, D.W.; Brun, T., et al.,
J. Nucl. Med. **41**, 1369-1379 (2000).

PET/CT machine in radiotherapy



CT

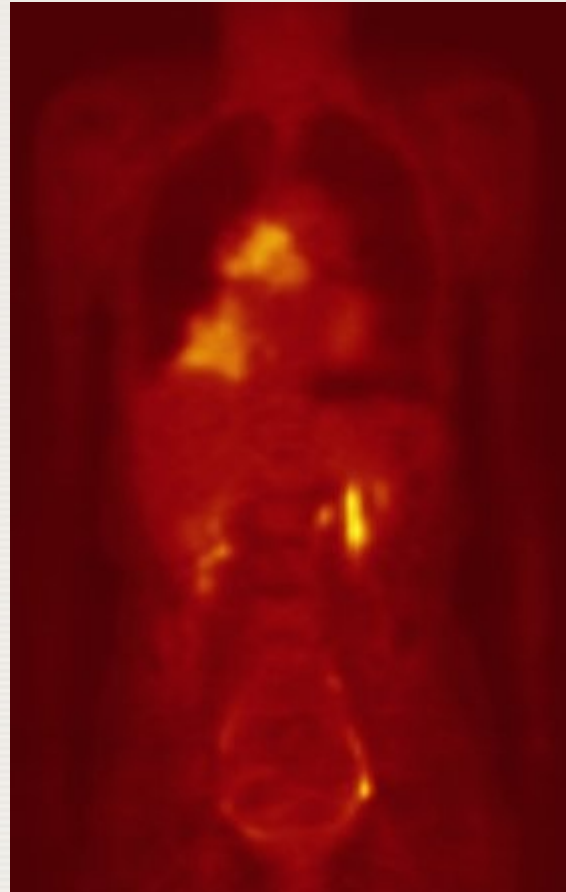

PET

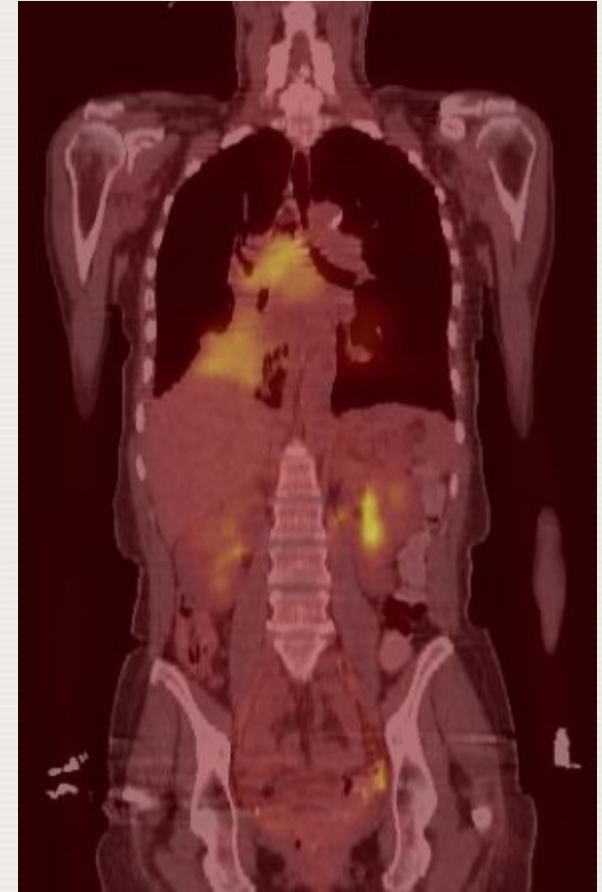

CT + PET

*Images courtesy of T. Rock Mackie
University of Wisconsin, Madison*

MRI or PET/CT for treatment planning?

Osseous metastasis from NCCLC

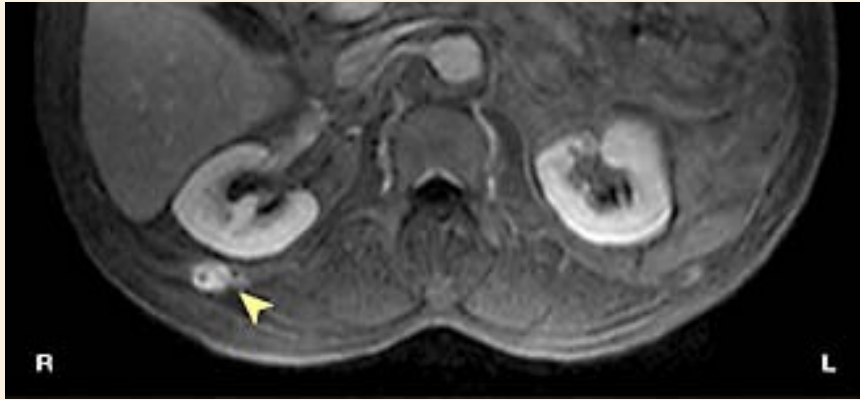

POSITIVE with MRI

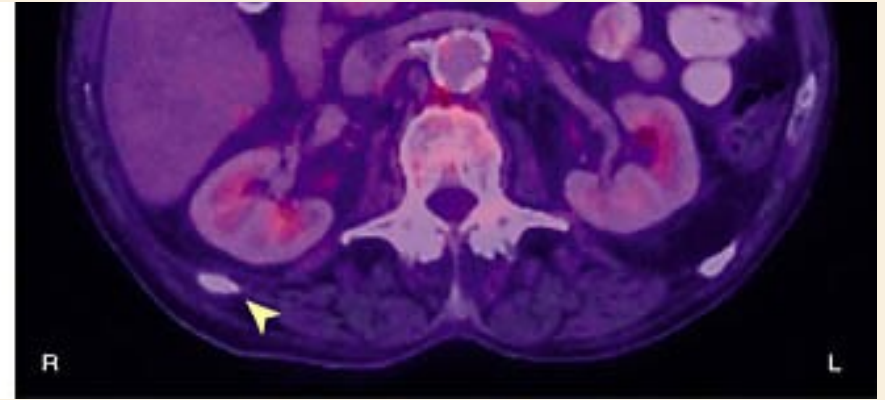

NEGATIVE with PET/CT

Oropharyngeal carcinoma

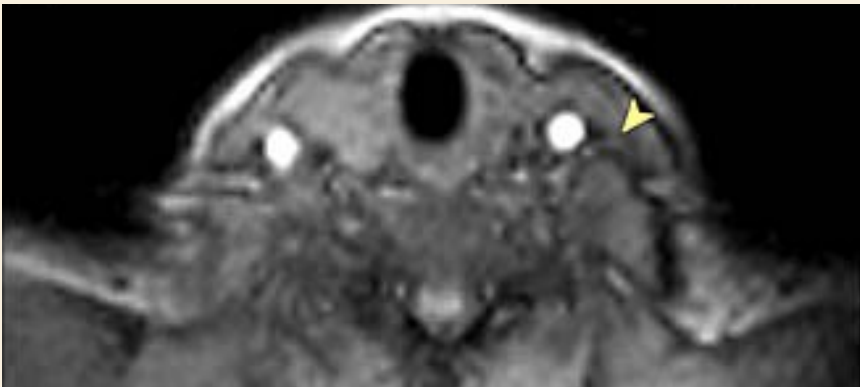

NEGATIVE with MRI

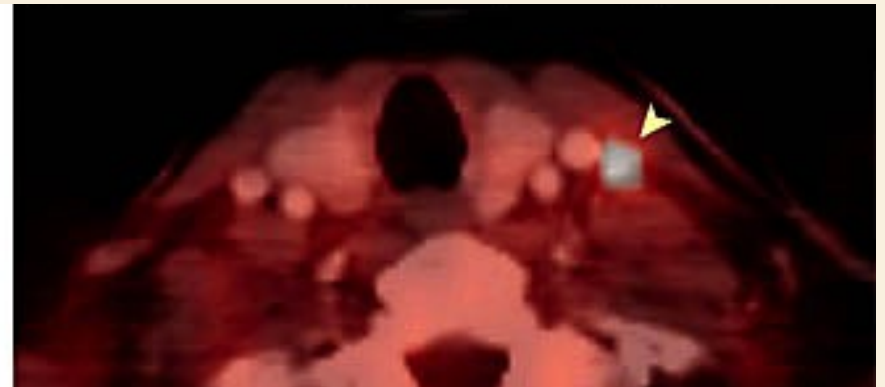

POSITIVE with PET/CT

Antoch et al., JAMA 290, 24 (2003)

Slide from Annette Franson

Modern radiotherapy process

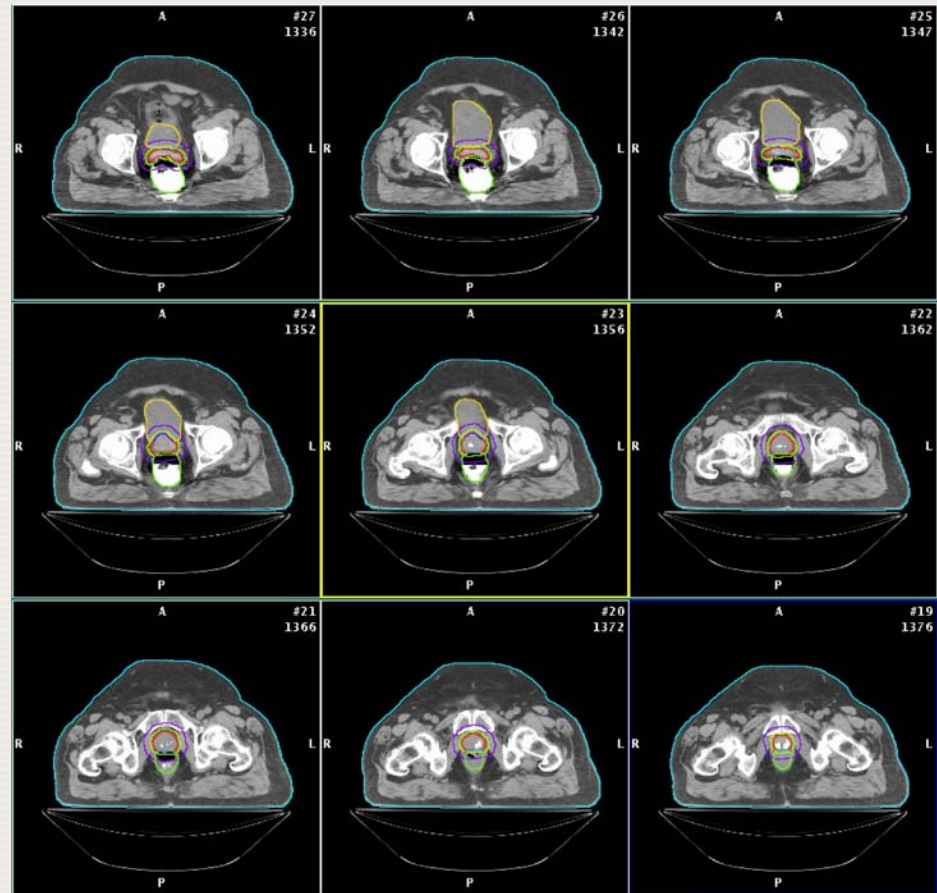
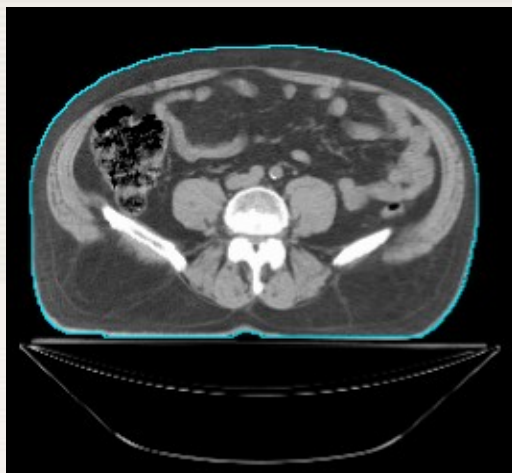
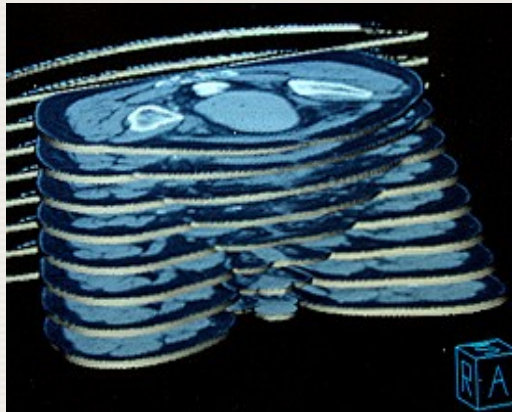

Modern radiotherapy process

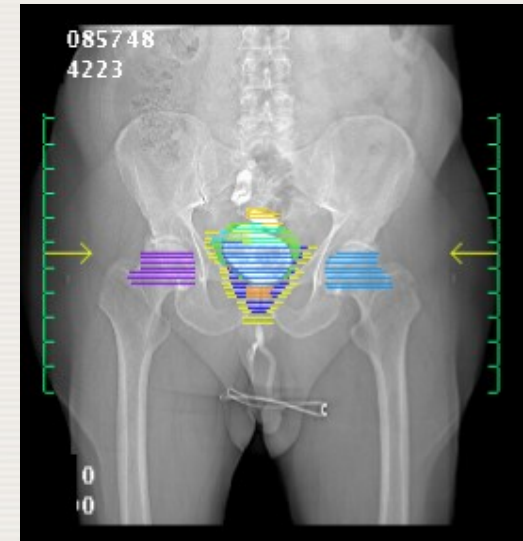
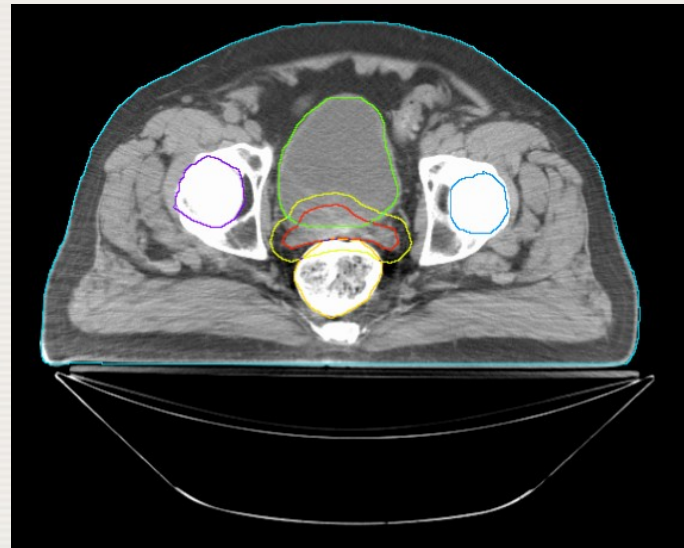
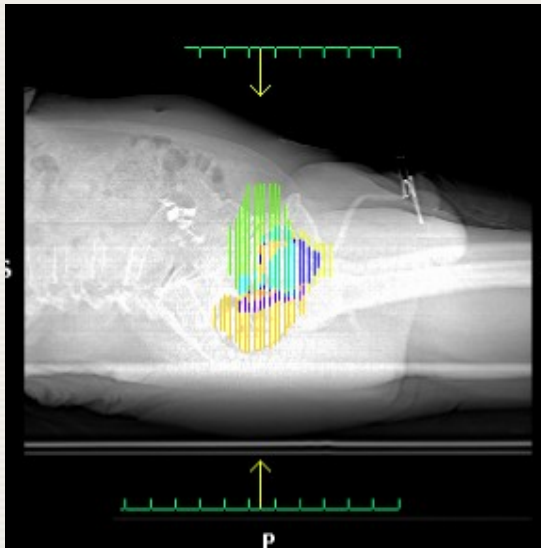

Modern basis for radiotherapy

CT axial (transverse) slices representing patient's anatomy

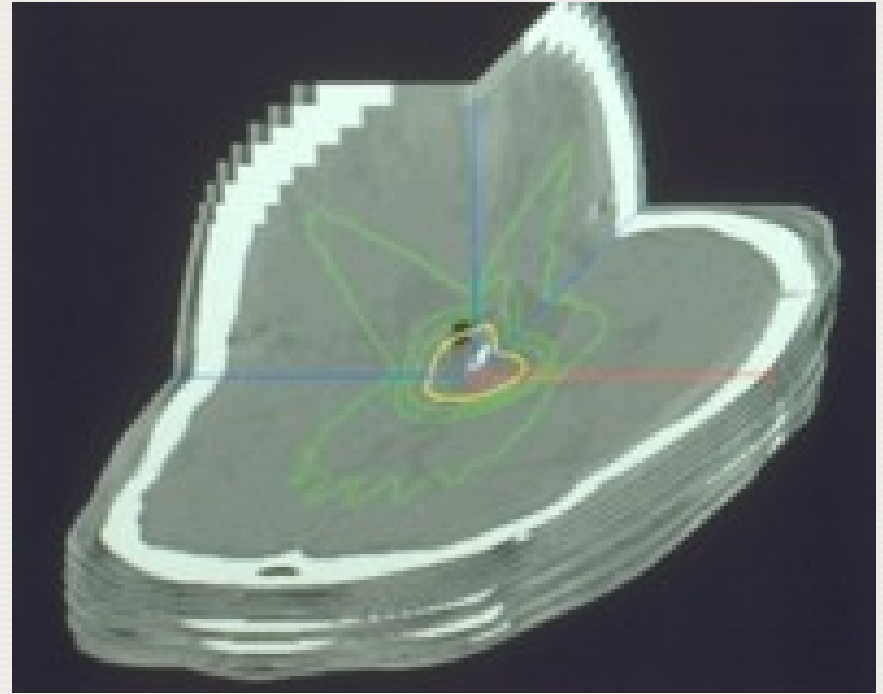
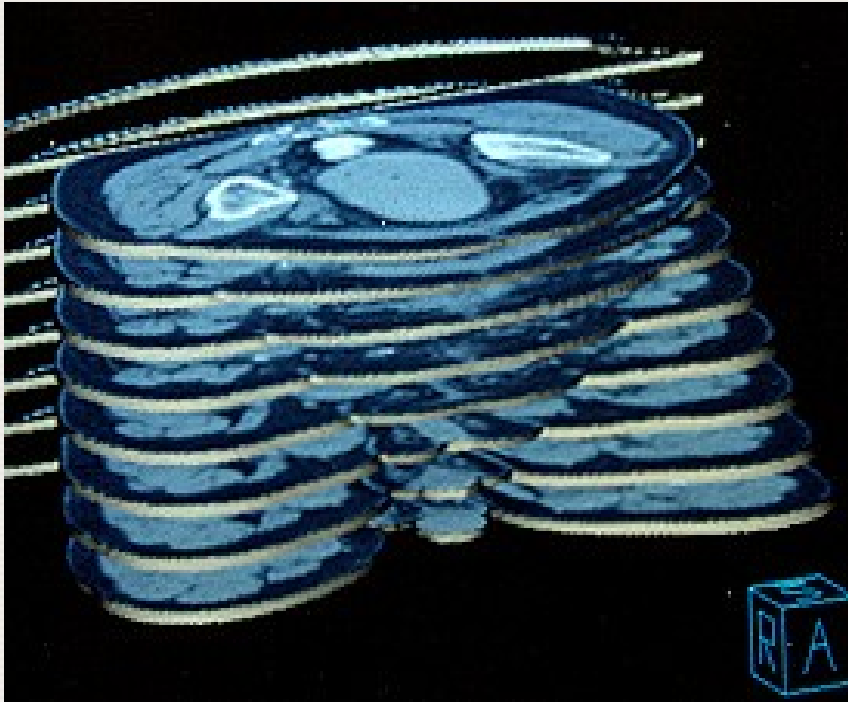

Target volumes in radiotherapy

ICRU 50 and ICRU 62

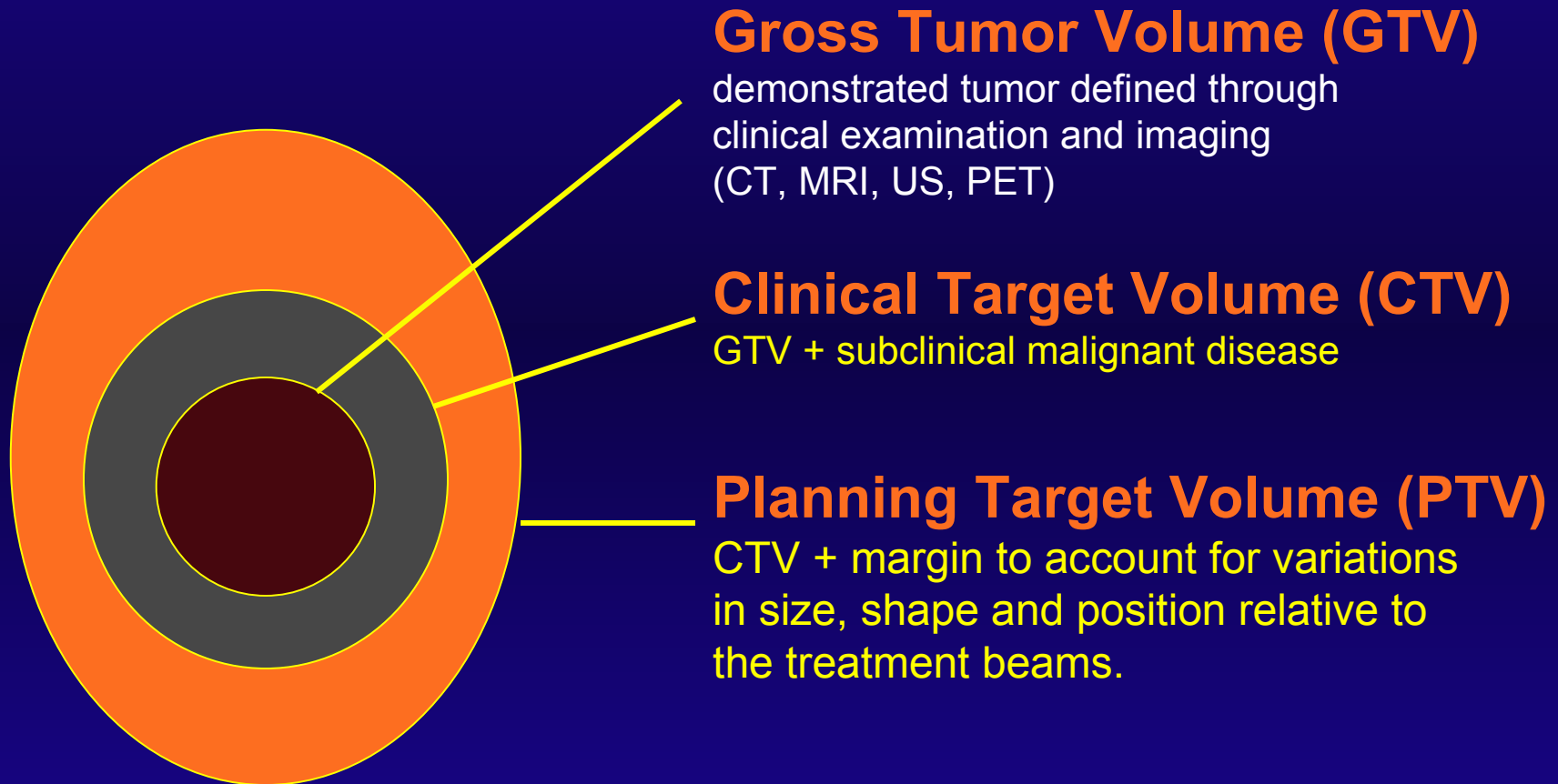

Target volumes in radiotherapy

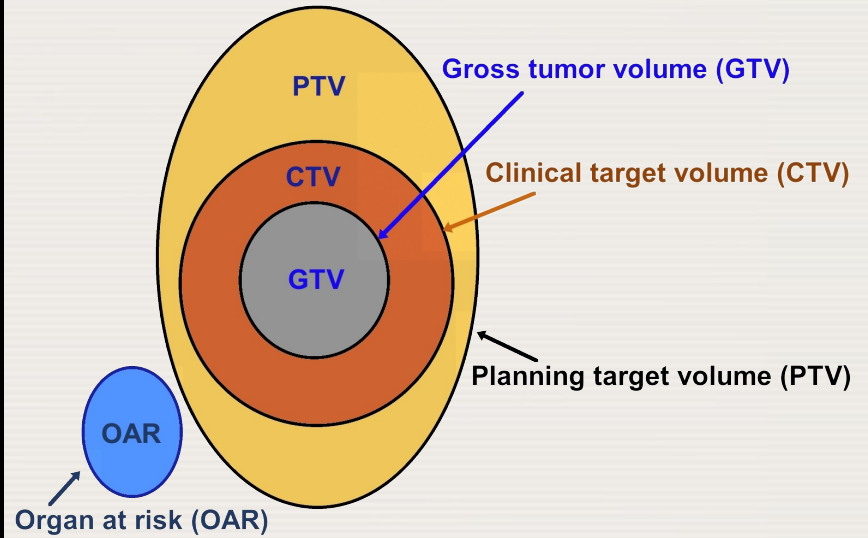
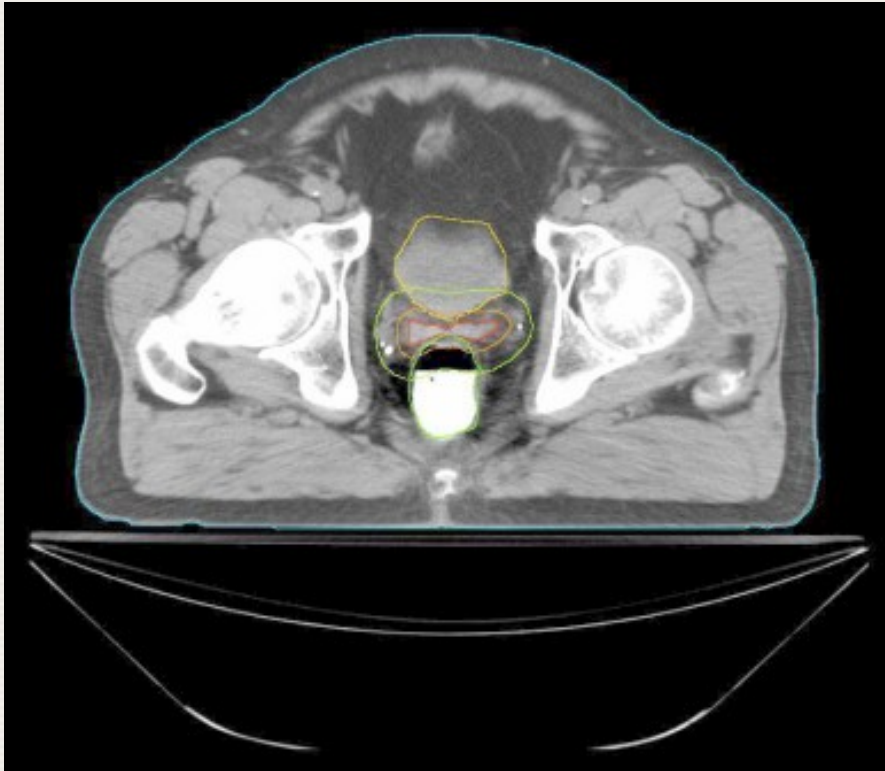

Target volumes in radiotherapy

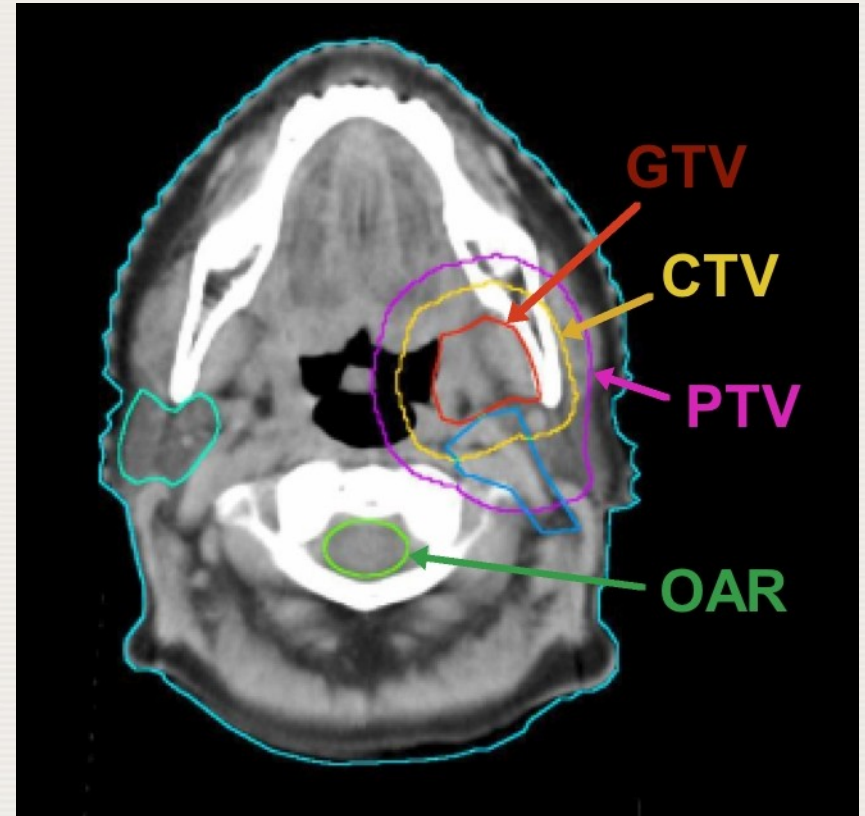
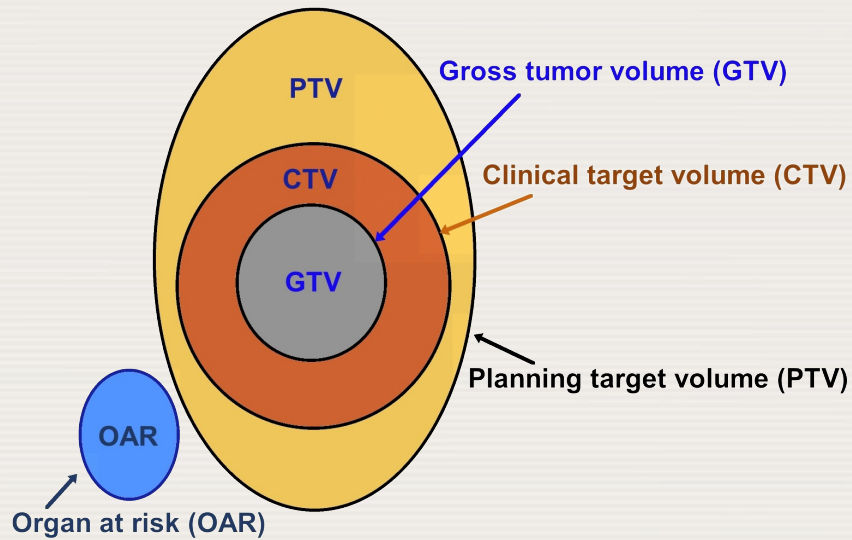

Target volumes in radiotherapy

□ Anatomical target volumes

Gross tumor volume (GTV)
Clinical target volume (CTV)
Planning target volume (PTV)
Organ at risk (OAR)

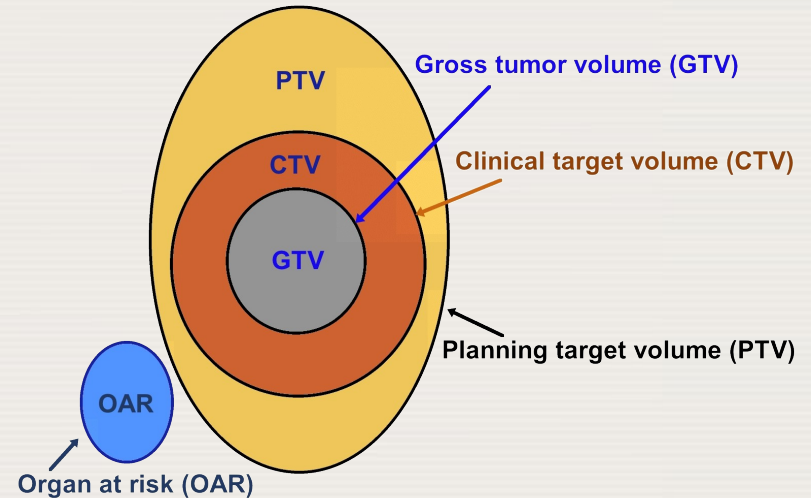

□ Biological target volumes

Metabolism, blood flow, proliferation, hypoxia,
tumor specific receptors, angiogenesis, apoptosis

Modern radiotherapy process



2D treatment planning is based on a single contour and homogeneous field intensities

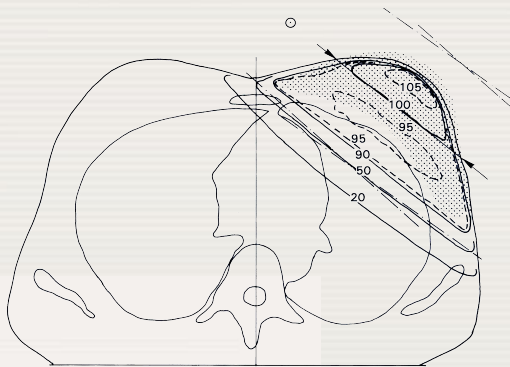

3D treatment planning is based on a set of axial CT slices and homogeneous field intensities (conformal radiotherapy).

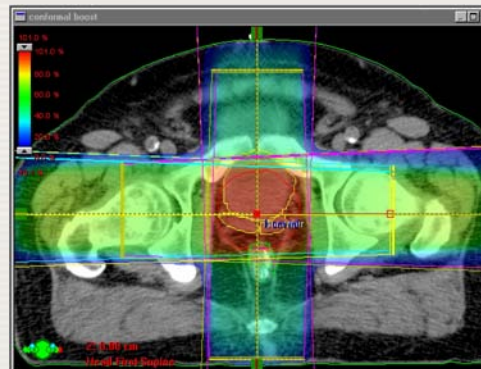

Inverse treat. planning is based on calculation of intensity modulated fields to obtain desired target dose distribution.

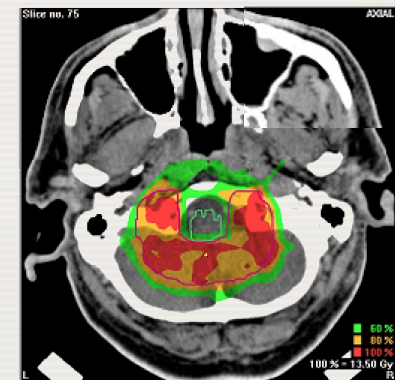

Treatment planning in radiotherapy

Example: Target volume wrapped around the brain stem

Conformal beams

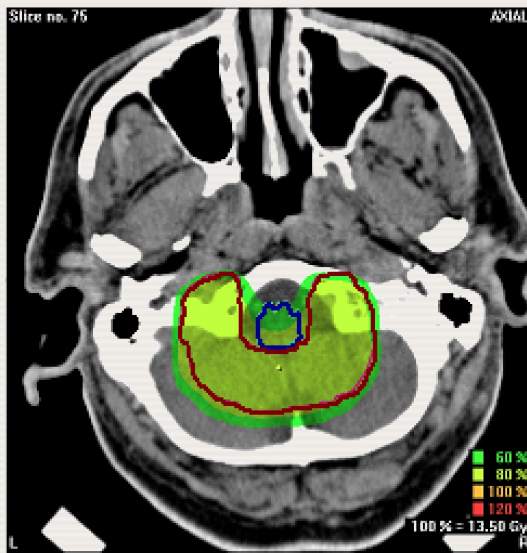

- + Good target coverage
- Irradiation of brain stem

Optimized beams

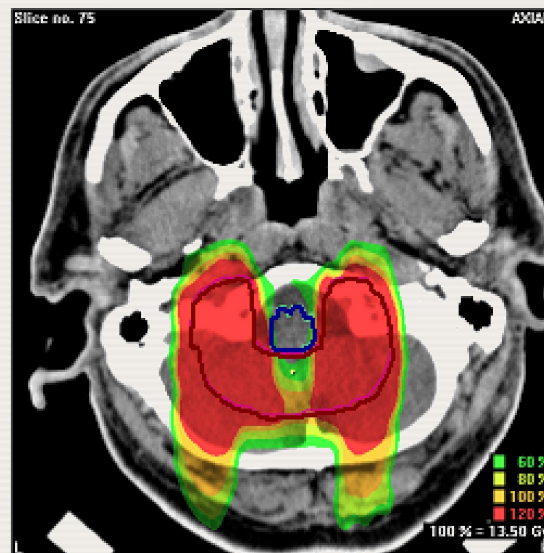

- Underdosage of target
- + Brain stem protected

Intensity modulated

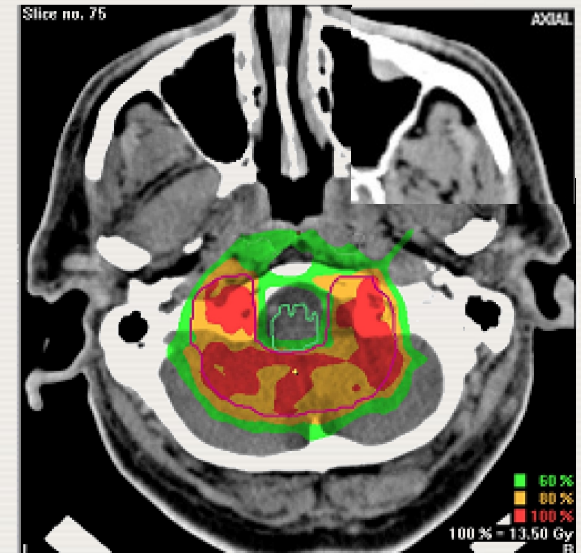

- + Good target coverage
- + Brain stem protected

7 non-coplanar conformal beam plan

4-field conformal plan

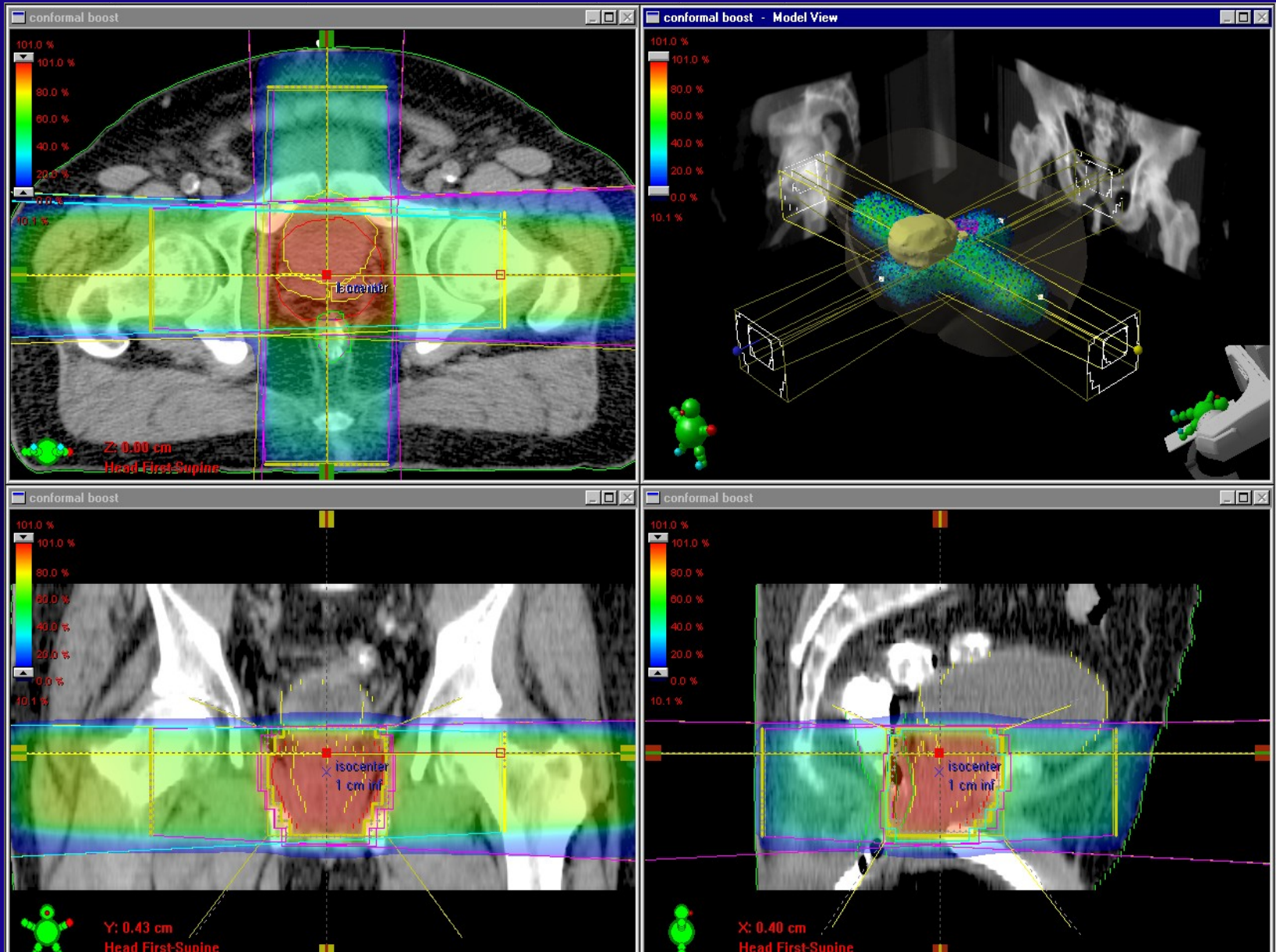

5-field IMRT treatment plan

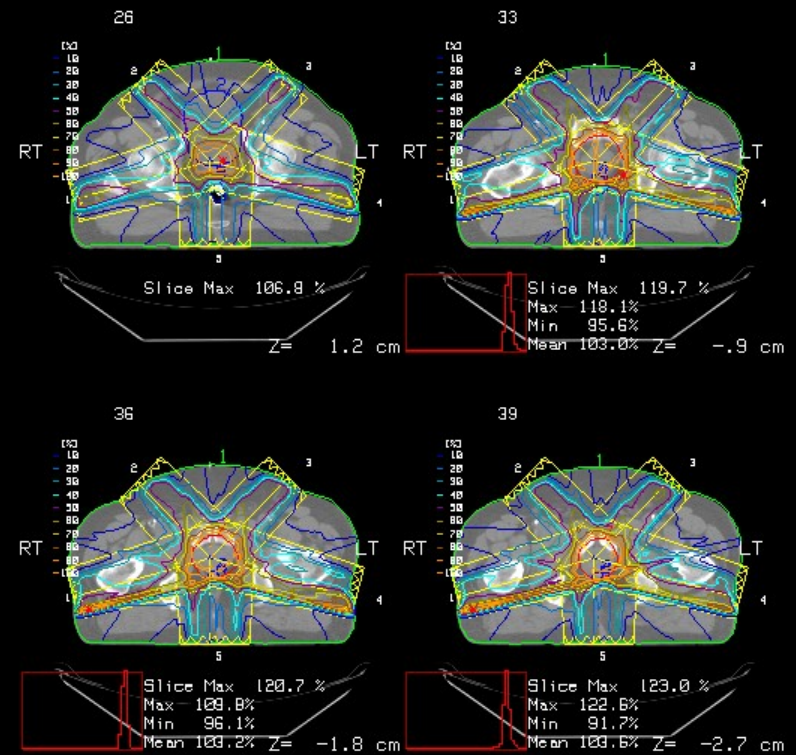
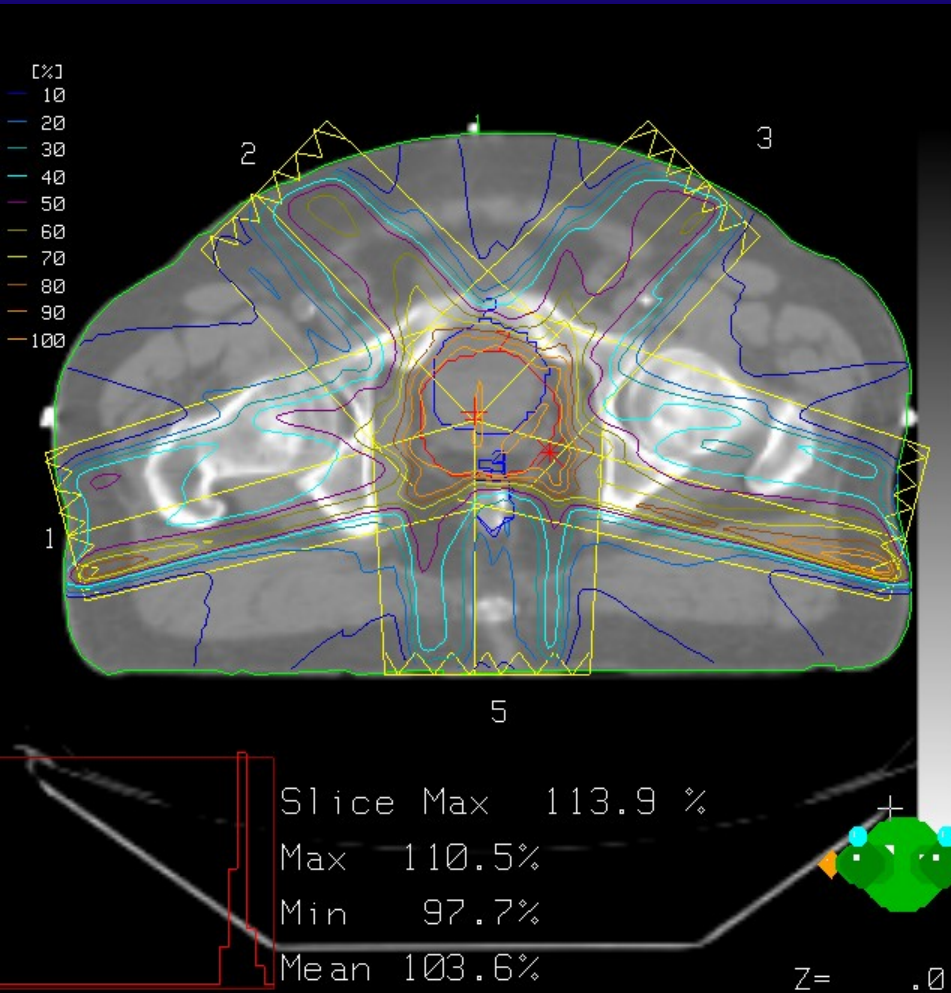

Modern radiotherapy process

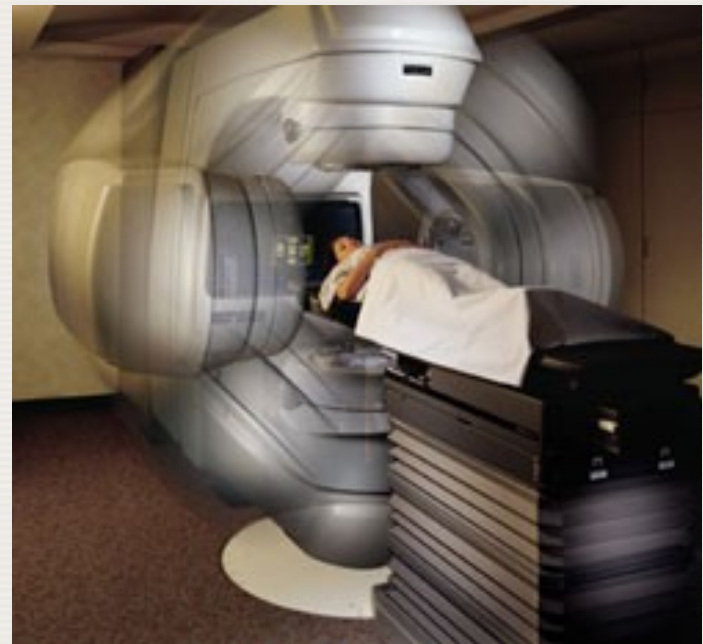

Clinical x-ray beams

- **Clinical x-ray beams** typically range in energy between 10 kVp and 50 MV and are produced in x-ray targets when electrons with kinetic energies between 10 keV and 50 MeV strike special metallic targets.
- In the target most of the electron's kinetic energy is transformed into heat, and a small fraction of the kinetic energy is emitted in the form of x ray photons which are divided into two categories:
 - **Characteristic x rays** following electron-orbital electron interactions.
 - **Bremsstrahlung photons** following electron - nucleus interactions.

X-RAY TARGETS

Angular distribution of x-rays

$$S(\theta) \propto \frac{\sigma v^2 \theta}{(1 - \beta \chi_0 \sigma \theta)^5} ; \quad \left. \frac{\delta \Sigma(\theta)}{\delta \theta} \right|_{\theta = \theta_{\mu \alpha \xi}} = 0$$

$$\theta_{\mu \alpha \xi} = \alpha \rho \chi_0 \sigma \left\{ \frac{1}{3\beta} (\sqrt{1 + 15\beta} - 1) \right\}$$

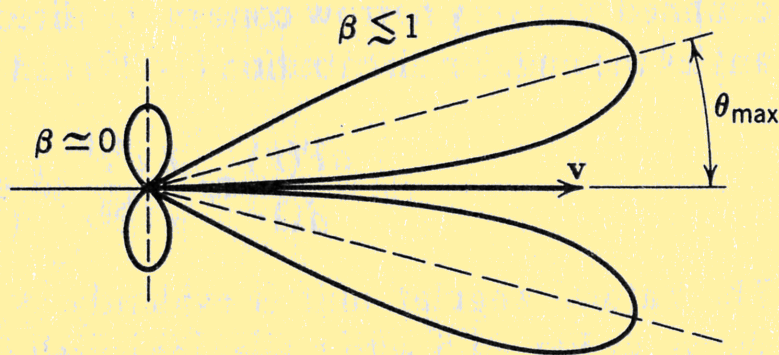

J.D. Jackson

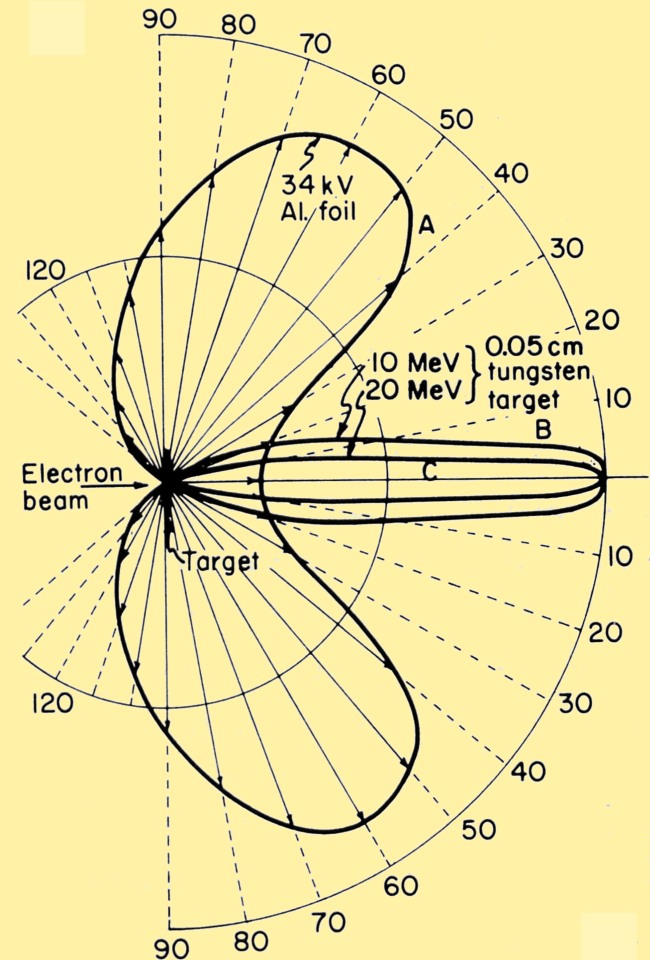

H.E. Johns and J.R. Cunningham

Clinical x-ray beams

- ❑ In the **diagnostic energy range** (10 - 150 kVp) most photons are produced at 90° from the direction of electrons striking the target (x-ray tube).
- ❑ In the **megavoltage energy range** (1 - 50 MV) most photons are produced in the direction of the electron beam striking the target (linac).

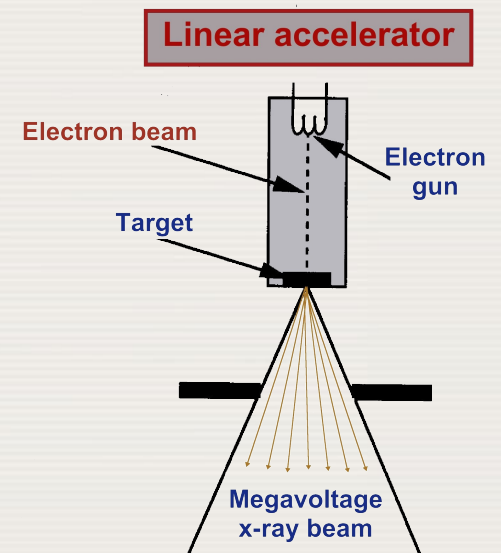
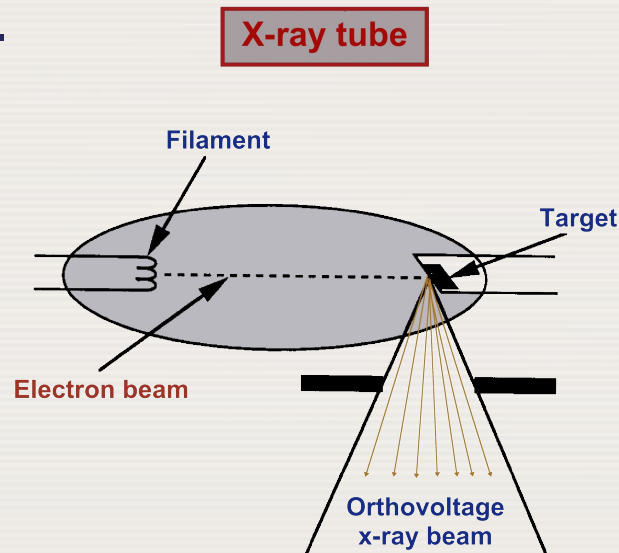

Equipment for dose delivery

- ❑ **1895** X-ray machine: Crookes type.
- ❑ **1913** X-ray machine: Coolidge type.
- ❑ **1940s** Van de Graaff generator and betatron.
- ❑ **1950s** Cobalt-60 teletherap.
- ❑ **1960s** Linear accelerator (linac) and Gamma Knife.
- ❑ **2000s** Tomotherapy machine and Cyberknife.

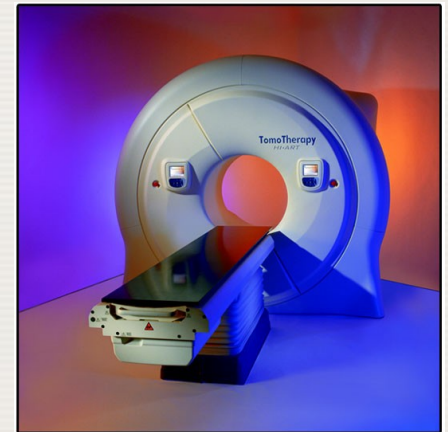

Particle accelerators

- ❑ Many types of accelerator have been built for basic research in nuclear physics and high energy physics.
- ❑ Most of these accelerators have been modified for at least some limited use in radiotherapy.
- ❑ Irrespective of accelerator type, **two basic conditions must be met for particle acceleration:**
 - The particle to be accelerated **must be charged**
 - **Electric field** must be provided in the direction of particle acceleration.

MEDICAL LINEAR ACCELERATOR





Clinical Linear Accelerator - schematic diagram

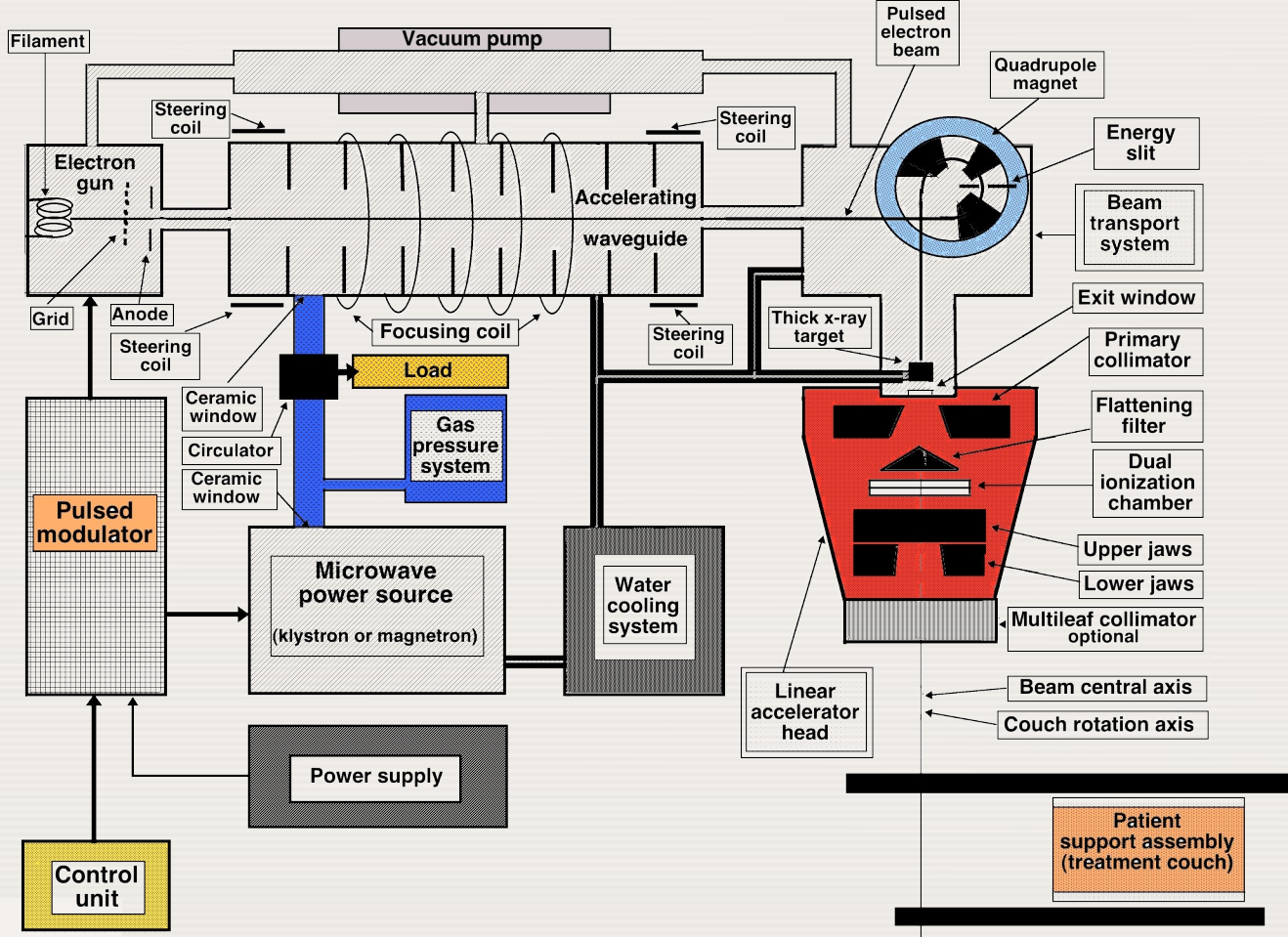

Accelerating waveguide

Travelling wave waveguide

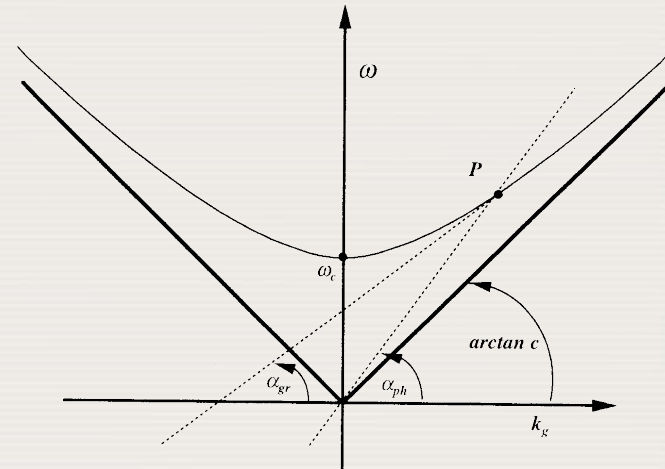
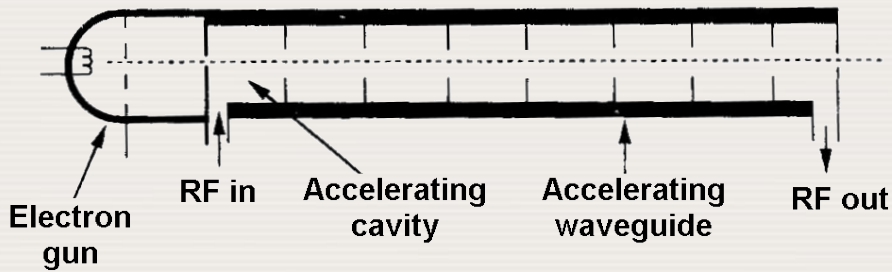

Standing wave waveguide

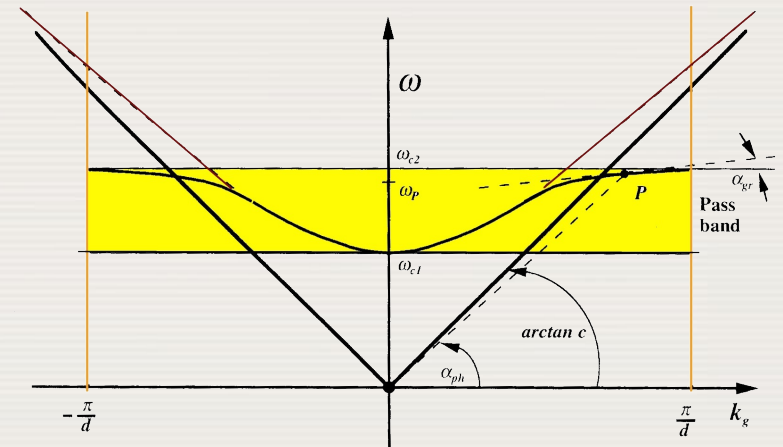
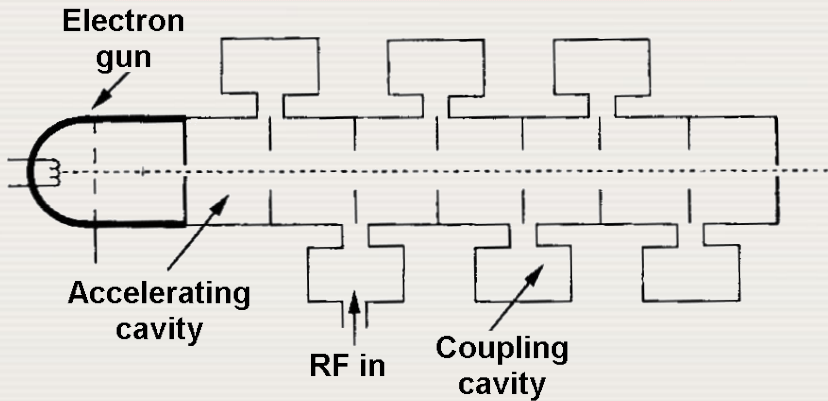

MEDICAL LINEAR ACCELERATOR

Clinac 2300EX with 120 leaf MLC

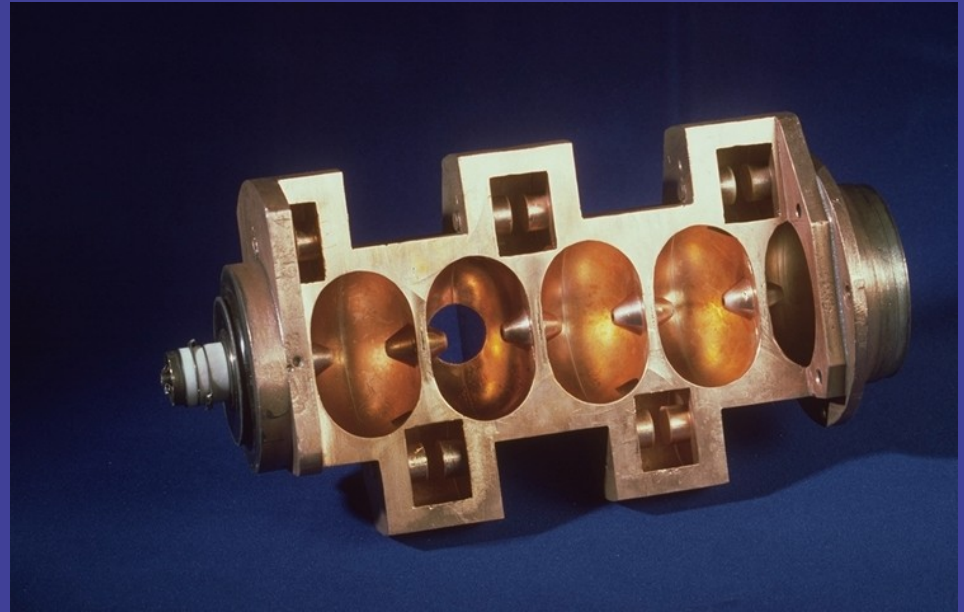

TYPICAL LINAC HEAD

for production of clinical beams

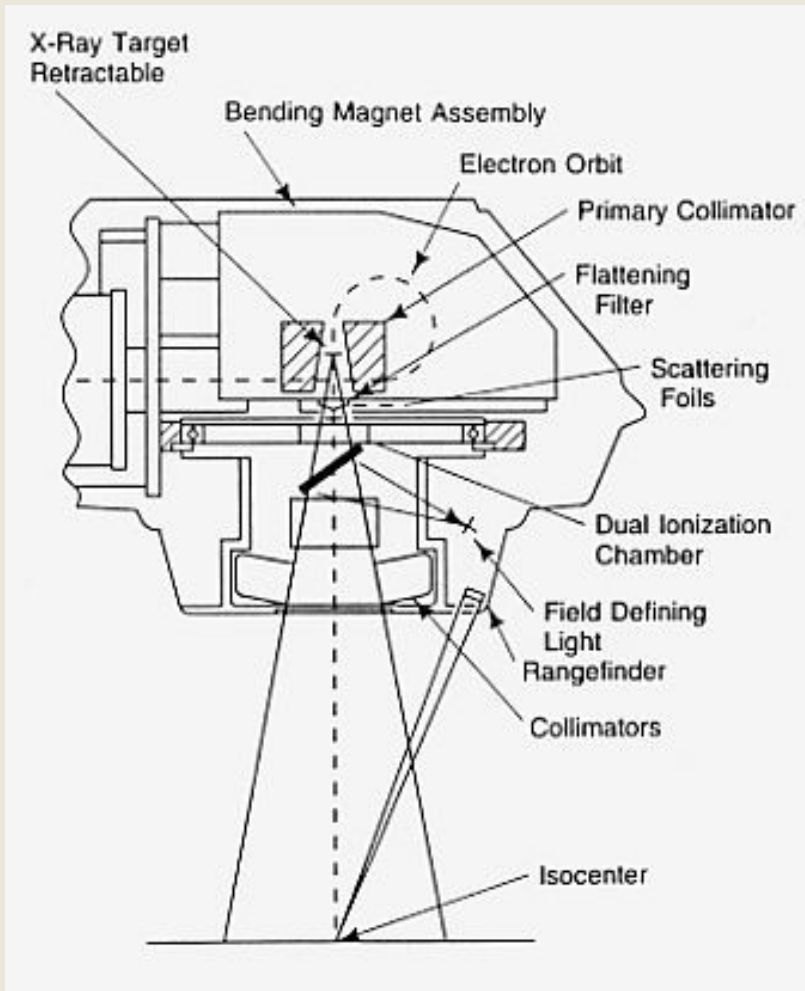

MAIN COMPONENTS

- X-ray target
- Flattening filter
- Scattering foil
- Dual ionization chamber
- Field defining light
- Distance indicator
- Collimators

Cobalt-60 teletherapy machine

**Harold E. Johns
(1915-1997)**



First cobalt-60 machine: 1951

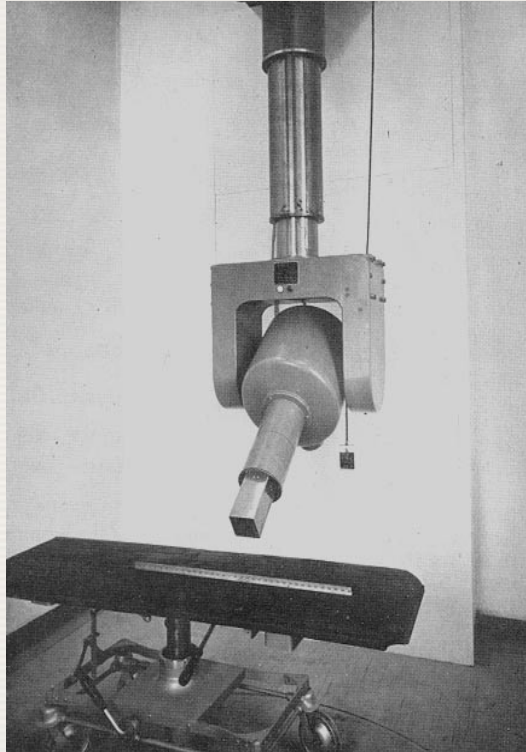

Built by **Atomic Energy of Canada:**
1970 - 2000

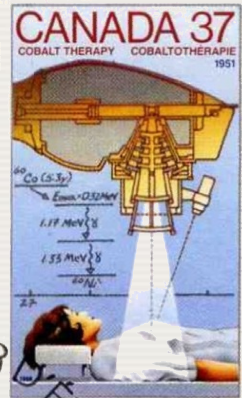
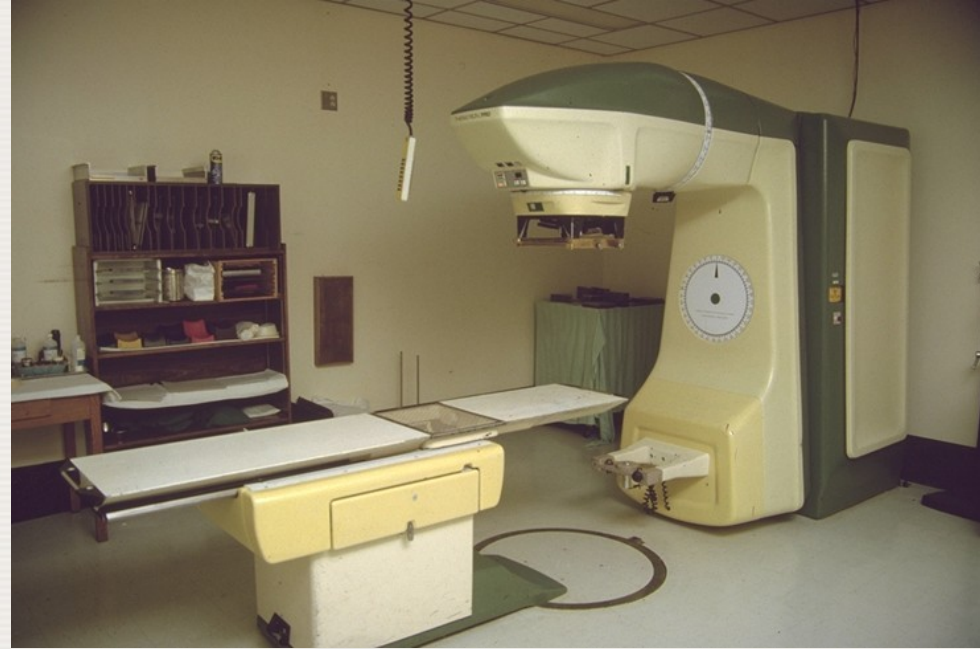

**Cobalt-60 teletherapy machine:
Canada's gift to the world**

Cobalt-60 teletherapy machine

Modern cobalt-60 teletherapy machine, MDS Nordion, Ottawa, Canada



CyberKnife Robotic Radiotherapy system



Developed by **John R. Adler** at Stanford University.

6 MV miniature X-band linac mounted on industrial robot.

Image-guidance is provided by orthogonal x-ray imaging systems.

Radiation fields are circular with diameters from 0.5 cm to 6 cm.

Tomotherapy Radiotherapy system

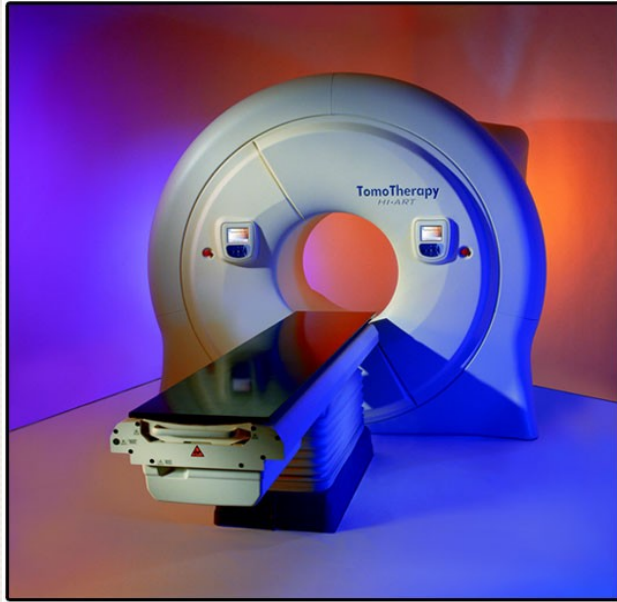

Developed by **Rock Mackie** at the University of Wisconsin in Madison.

6 MV miniature X-band linac mounted on a CT-type ring gantry (helical tomotherapy).

Beam intensity is modulated with a binary 64-leaf computer controlled MLC.

Image guidance is achieved with MVCT images obtained with xenon ionization chamber array.



SAD: 85 cm
Bore dia.: 85 cm
Max field size:
5x40 cm²

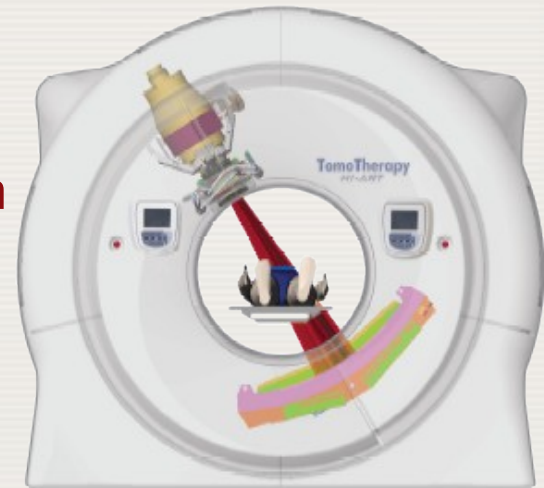

TECHNOLOGY for MODERN RADIOTHERAPY

- CT-simulator
 - Scanner
 - Virtual simulation
 - Digitally Reconstructed Radiograph (DRR)
- 3-D treatment planning system
- Linear accelerator equipped with
 - Multileaf collimator (MLC)
for field shaping and beam intensity modulation
 - Electronic portal imaging device (EPID)
for treatment verification and measurement of delivered dose
 - Cone beam CT

RADIATION THERAPY

- **External beam** (x rays, gamma rays, electrons)
 - x ray unit (superficial, orthovoltage)
 - Teletherapy isotope unit (cobalt-60)
 - Linear accelerator (4 - 25 MV)
- **Brachytherapy** (gamma rays, beta particles)
 - Radioactive seeds
 - Remote afterloader

RADIONUCLIDES in MEDICINE

Radiotherapy

Radionuclide	Half-life	Photon energies (MeV)
Cesium-137	30 yr	0.660
Cobalt-60	5.3 yr	1.17 and 1.33
Gold-198	2.7 d	0.4 - 1.1
Iodine-125	60 d	0.028
Iridium-192	74 d	0.14 - 1.1
Paladium-103	17 d	0.021
Radium-226	1620 yr	0.05 - 2.4

BRACHYTHERAPY- REMOTE AFTERLOADING

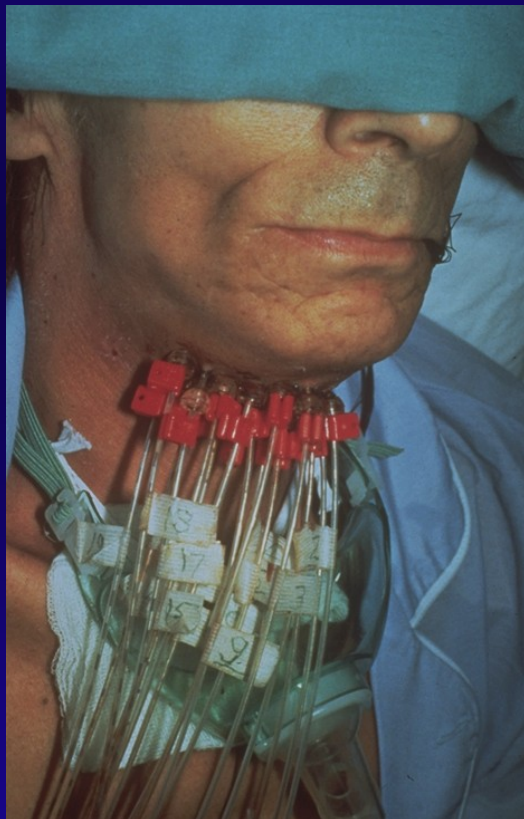

Special dose delivery techniques

- Total body irradiation (TBI)
- Total skin electron irradiation (TSEI)
- Stereotactic external beam irradiation (SEBI)
- Intraoperative radiotherapy (IORT)
- Endorectal irradiation (Endocavitary rectal irradiation)
- **Conformal radiotherapy**
- **Intensity modulated radiotherapy (IMRT)**
- **Image guided radiotherapy (IGRT)**

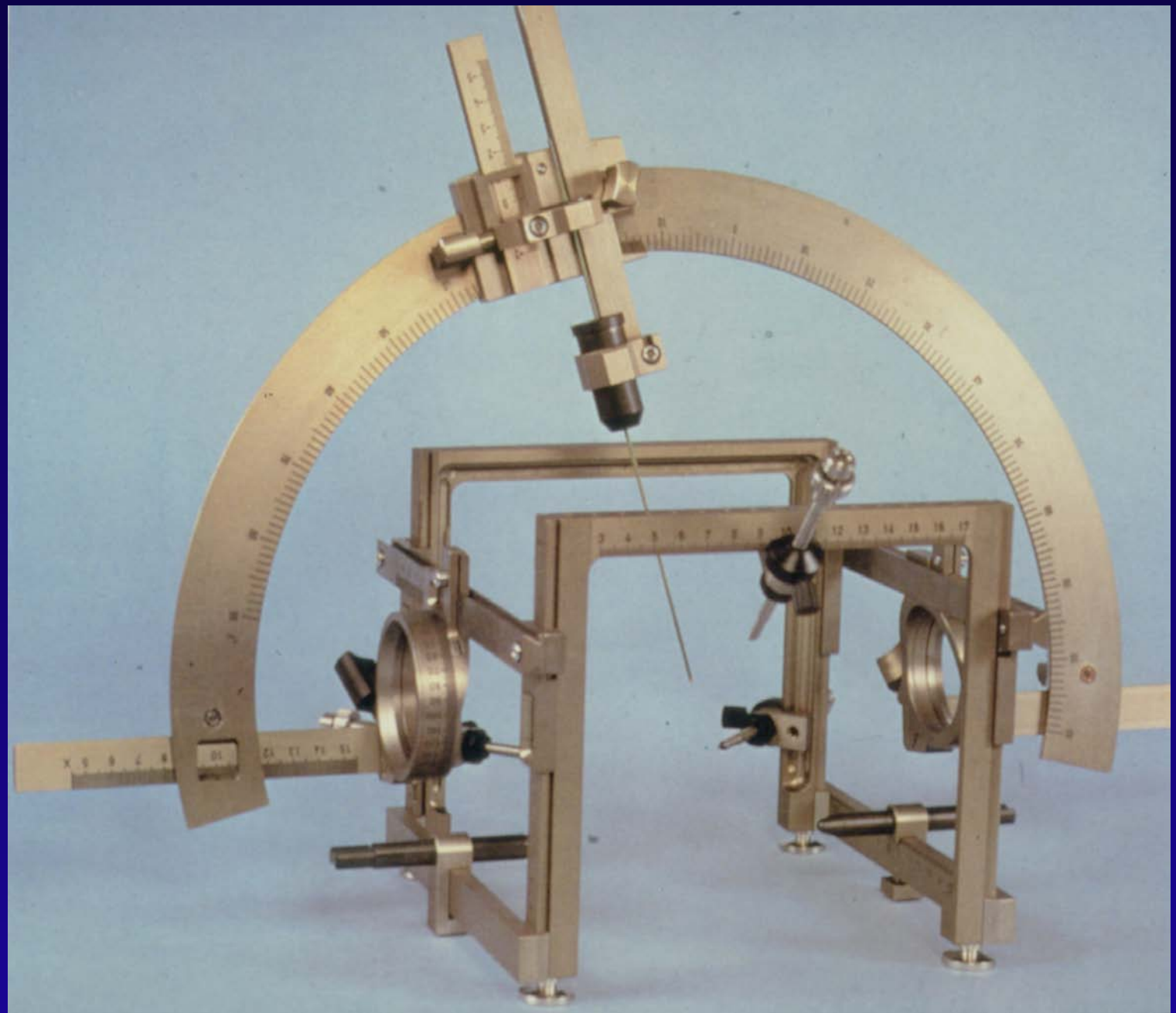

STEREOTACTIC FRAME and FIDUCIAL MARKER BOX

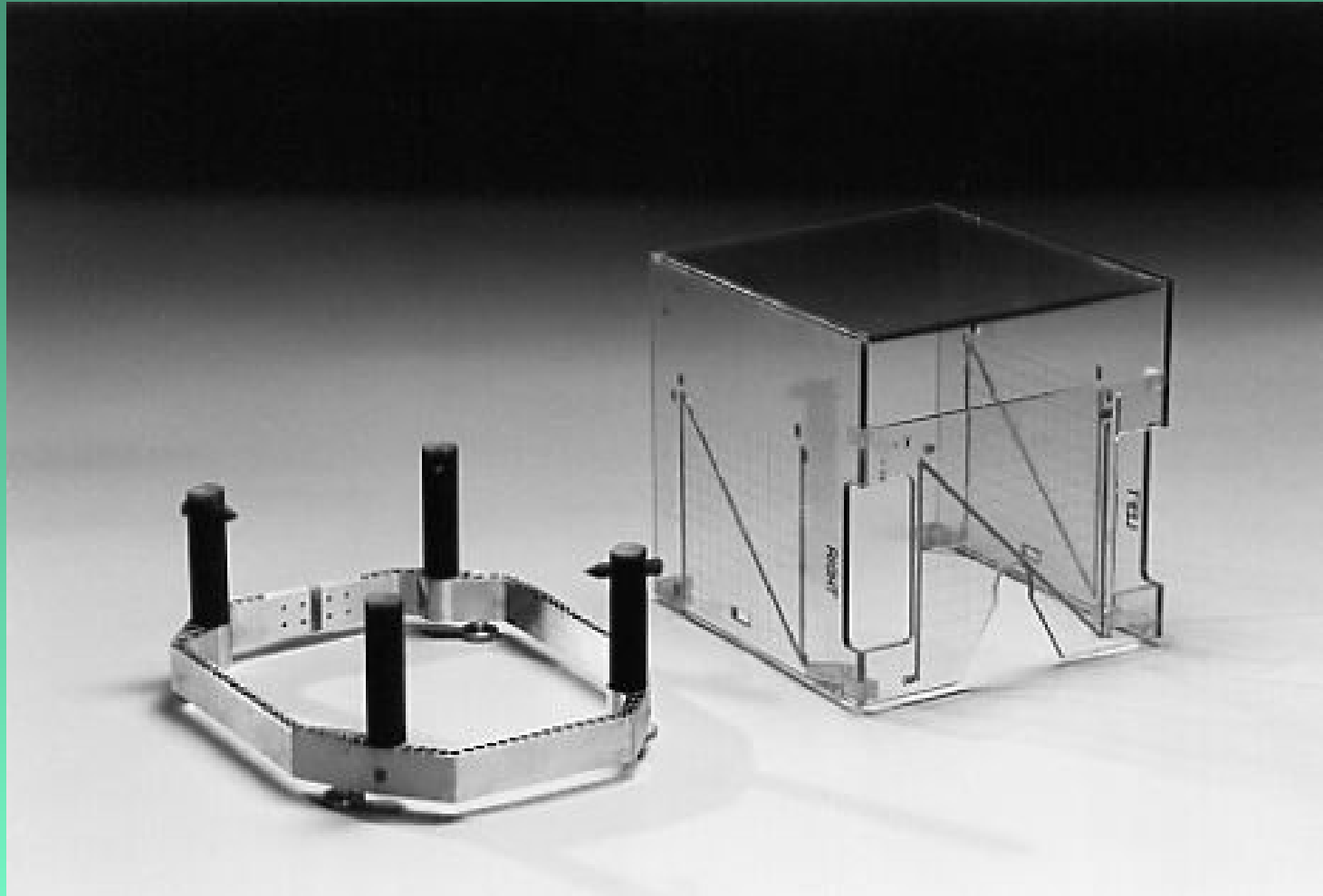

FIDUCIAL MARKERS

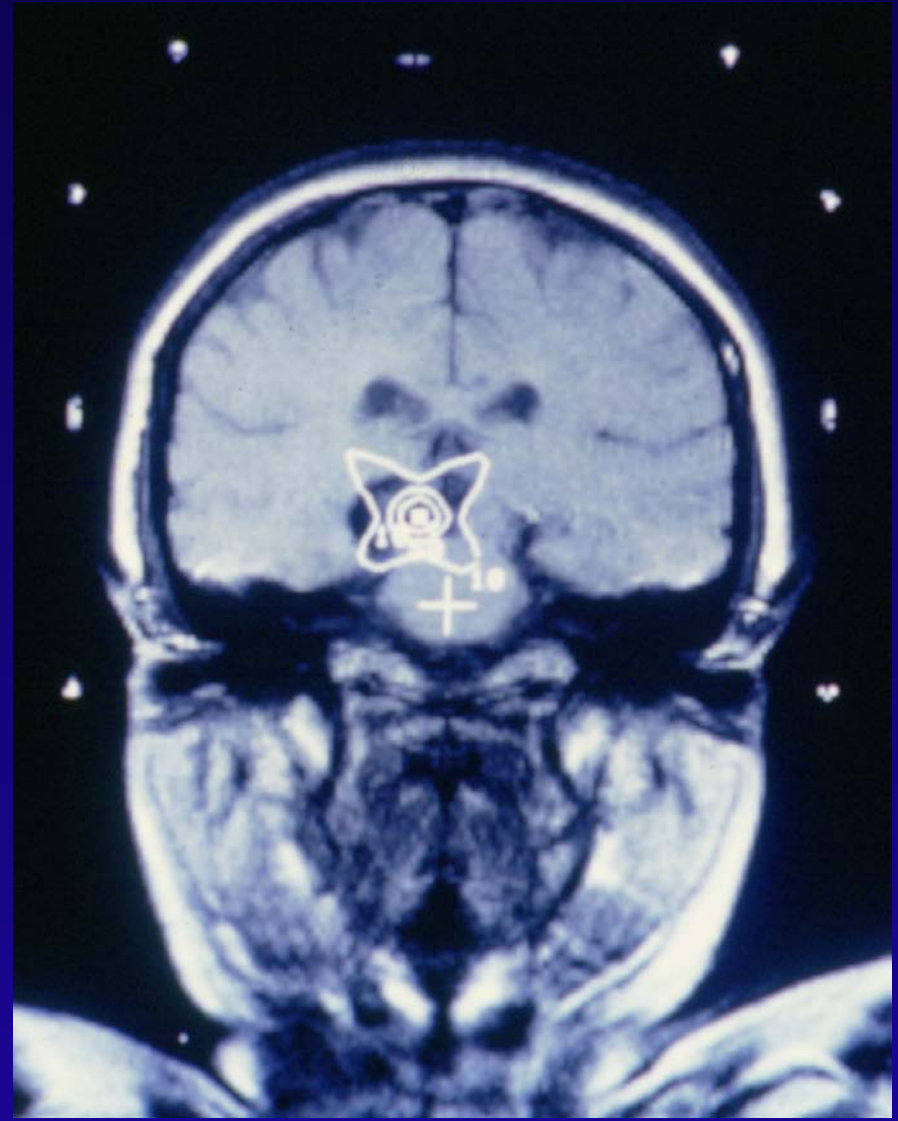
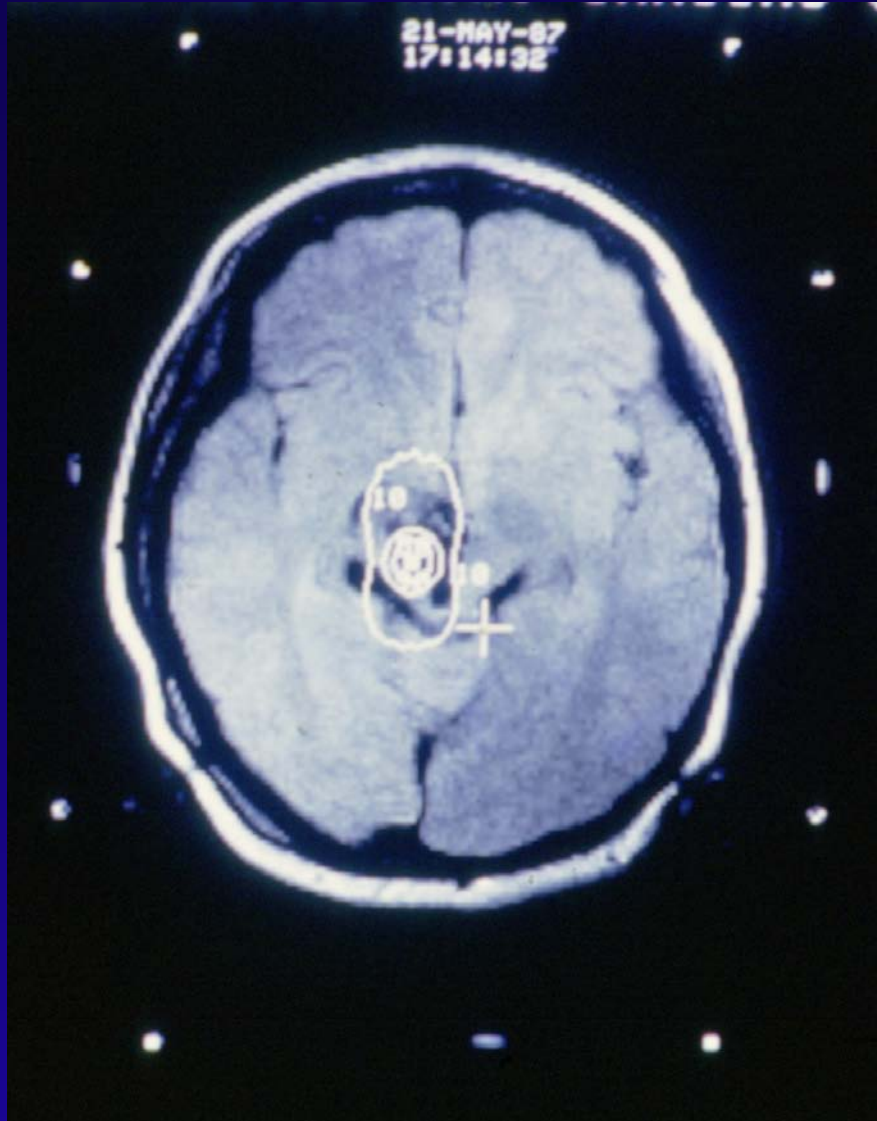

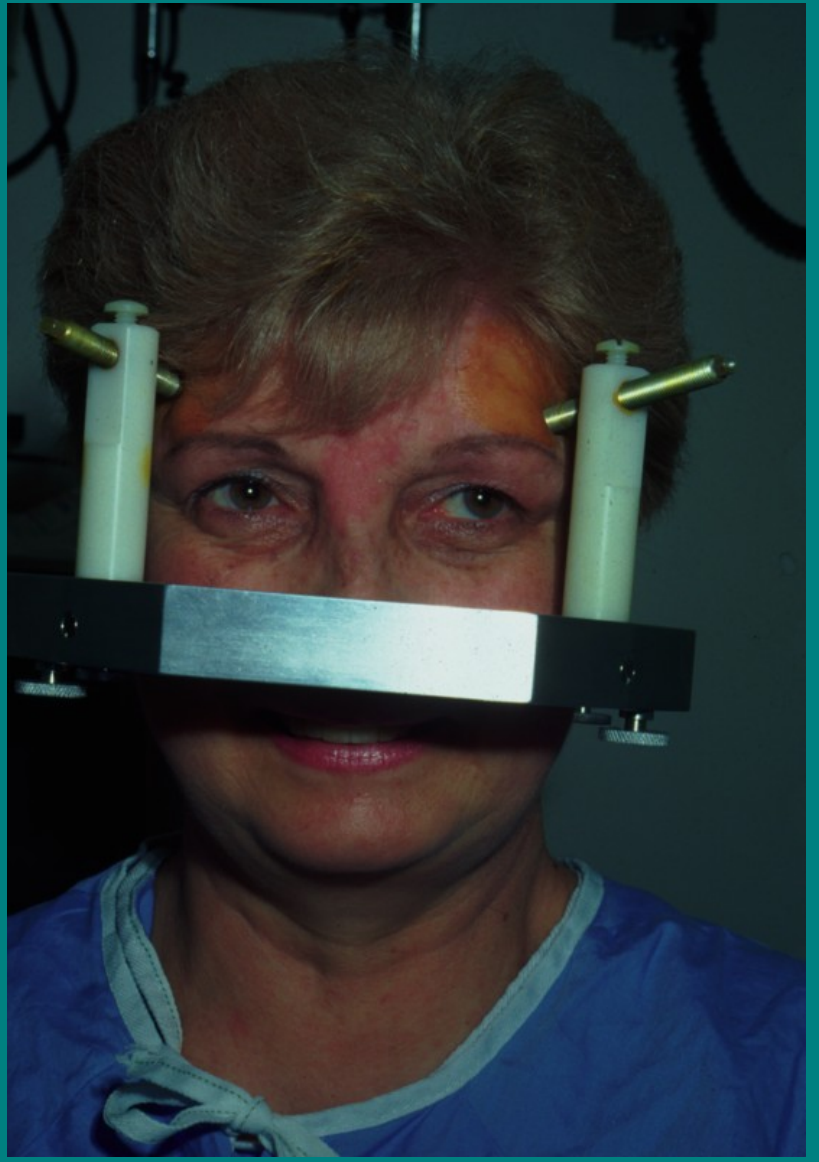

STEREOTACTIC RADIOSURGERY



Dynamic Stereotactic Radiosurgery

Concurrent rotation of linac gantry and treatment table

QuickTime^a and a decompressor are needed to see this picture.

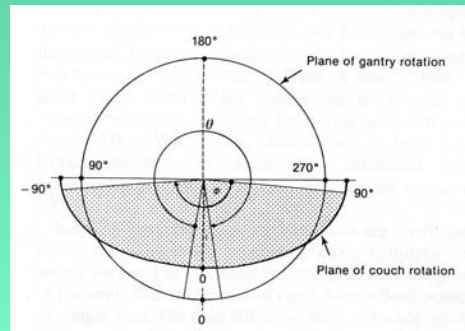
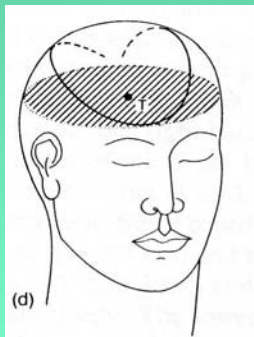

	$\theta_i = 30^\circ$ $\phi_i = 75^\circ$	
	$\theta = 90^\circ$ $\phi = 45^\circ$	
	$\theta = 180^\circ$ $\phi = 0^\circ$	
	$\theta = 225^\circ$ $\phi = -45^\circ$	
	$\theta_f = 330^\circ$ $\phi_f = -75^\circ$	



ARTERIO-VENOUS MALFORMATION (AVM)

Treatment with Stereotactic Radiosurgery

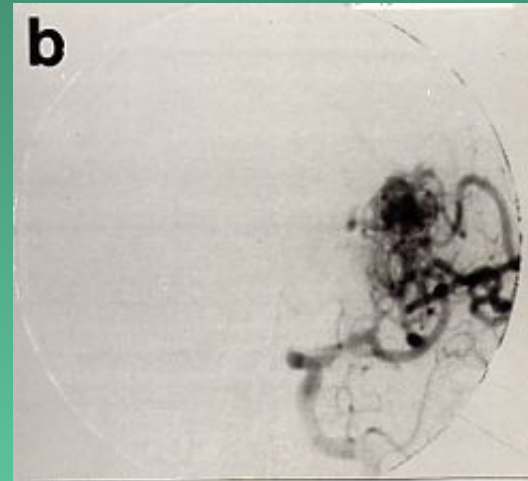
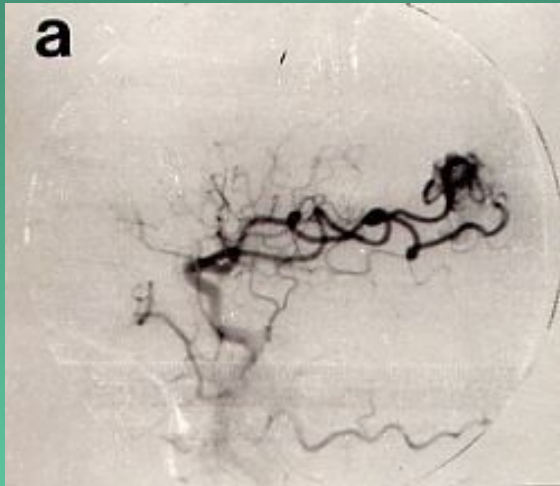

Time: 0



Time: 6 mo

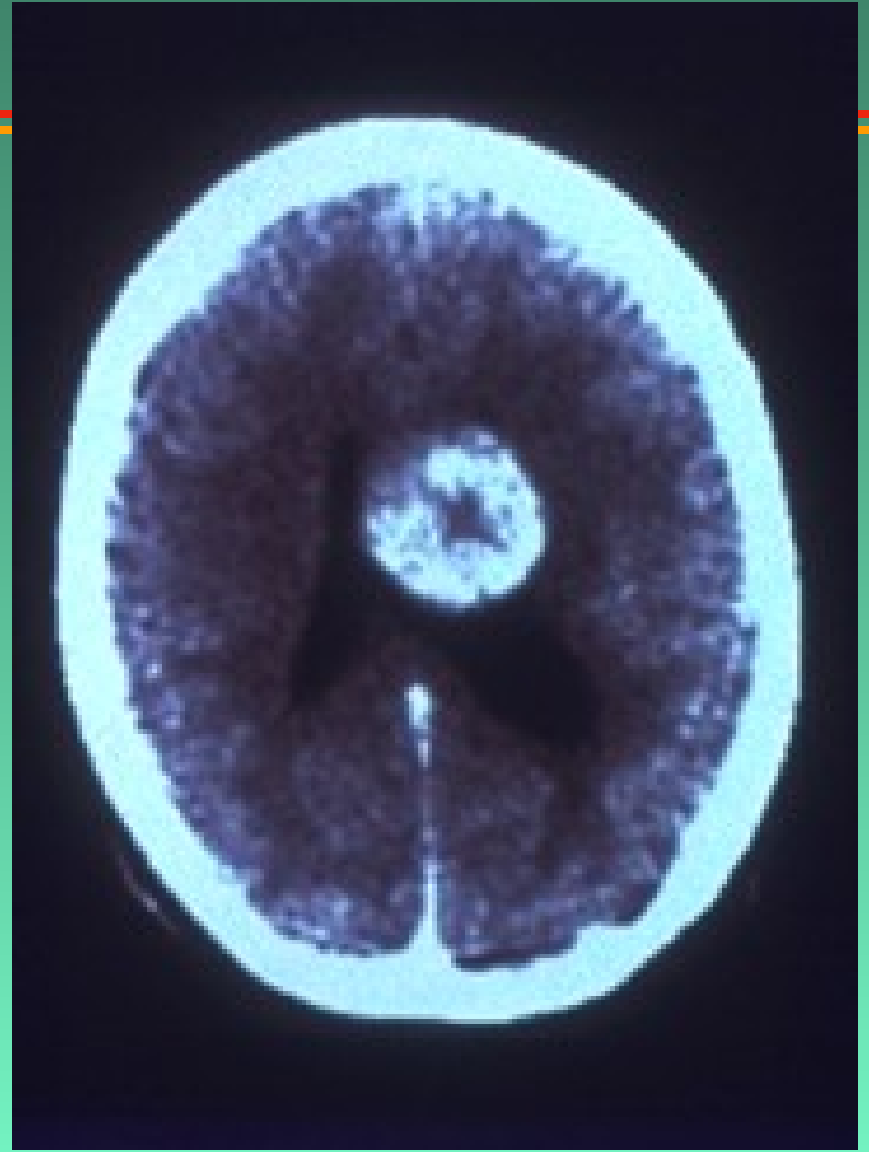
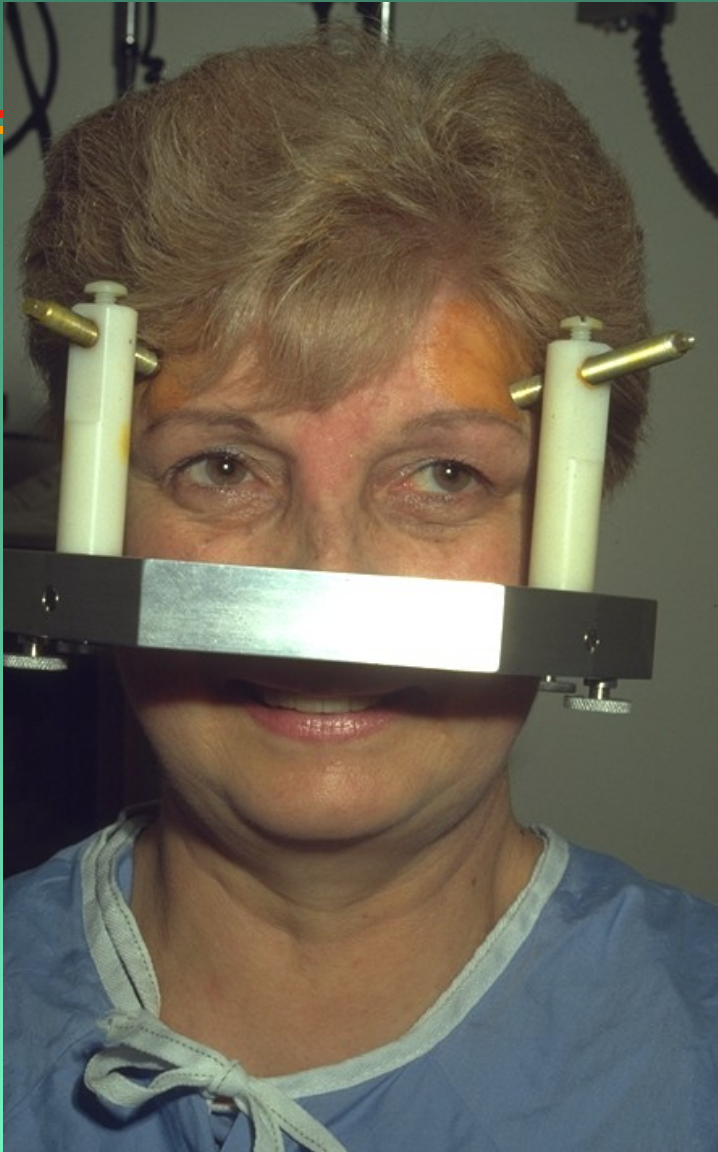

Radiosurgery: Solitary Metastatic Tumor

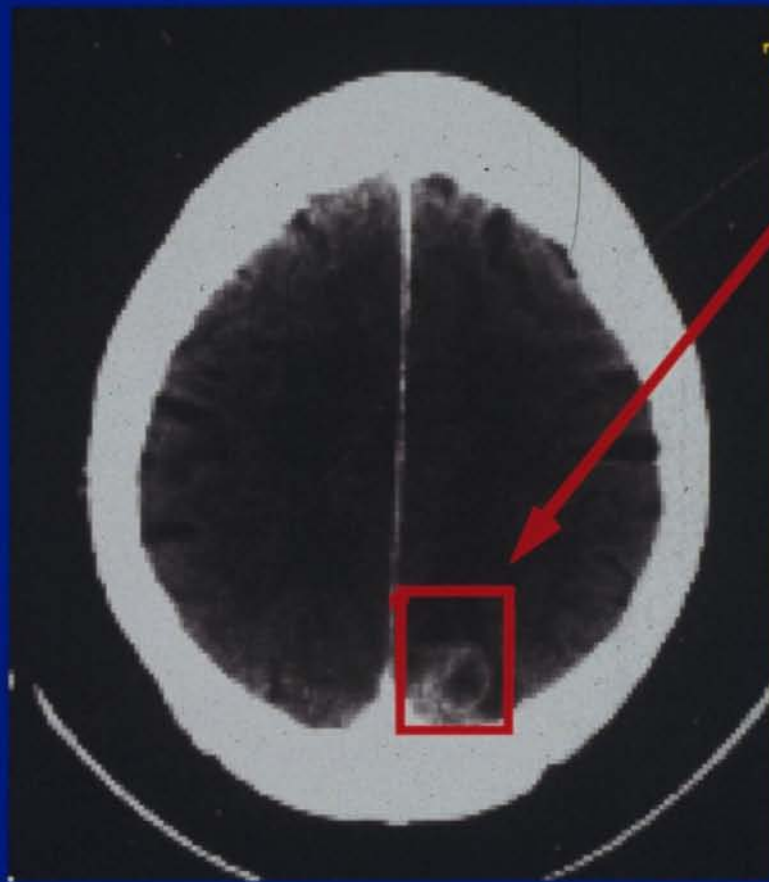

Pre -Treatment

Tumor Zone

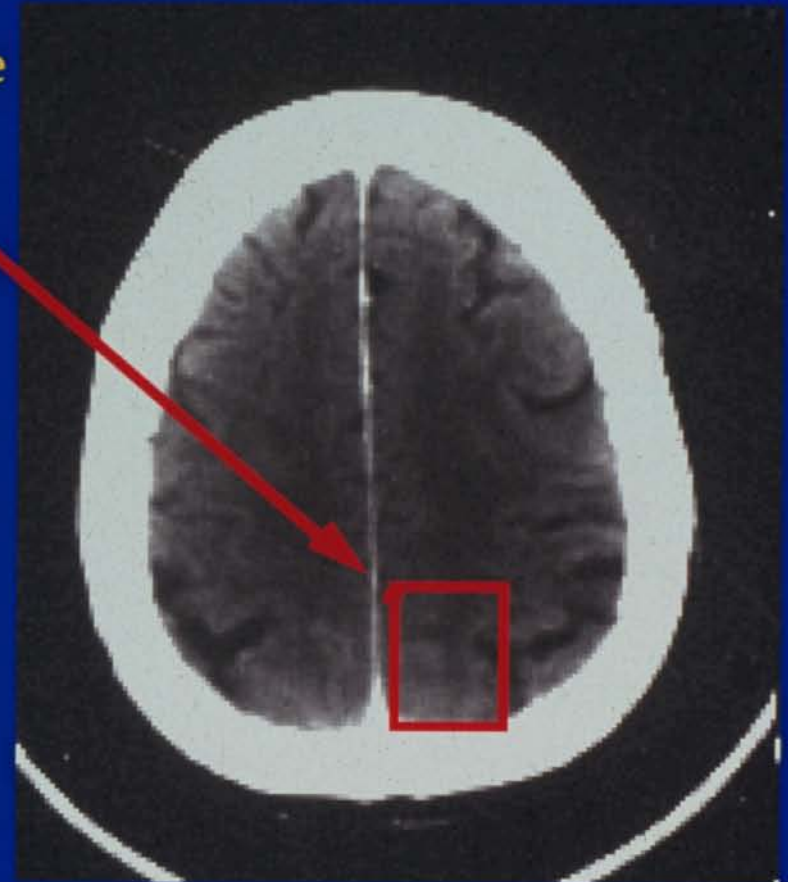

3 Months After Single
Fraction of 20 Gy

Scientific forces influencing medical physics

- 1890** - Basic physics research
- 1900** - Atomic physics
- 1910** -
- 1920** -
- 1930** - Nuclear and particle physics
- 1940** -
- 1950** -
- 1960** - Computer science
- 1970** - Imaging science
- 1980** -
- 1990** - Biotechnology
- 2000** - Nanotechnology

Pathway to becoming medical physicist

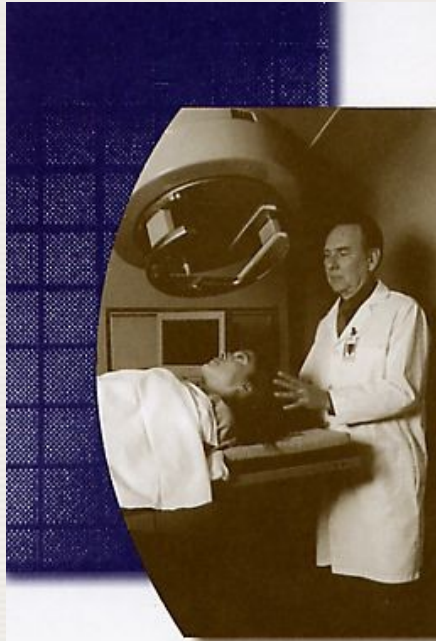

*The Medical
Physicist*



American Association of
Physicists in Medicine

□ Academic training

- B.Sc. in physics
- M.Sc. in medical physics
- Ph.D. in medical physics (optional)

□ Clinical training

- Two-year residency in clinical department
- Two years on-the-job training

□ Professional certification

by national or international certifying body

- American Board of Radiology
- American College of Medical Physics
- Canadian College of Physicists in Medicine

ACCREDITED GRADUATE PROGRAMS in MEDICAL PHYSICS

Accreditation:

**Commission on Accreditation of Medical Physics Education Programs
(CAMPEP)**

Sponsored by: American Association of Physicists in Medicine (AAPM)
American College of Medical Physics (ACMP)
American College of Radiology (ACR)
Canadian College of Physicists in Medicine (CCPM)

CAMPEP Accredited Graduate Programs in Medical Physics

Entries Last Updated April 4, 2007

Institution	Initial Accreditation	Renewal Due
East Carolina University	2006	2009
Louisiana State University	2006	2011
McGill University	1993	2008
University of Alberta - Cross Cancer Institute	2002	2007
University of British Columbia	2004	2008
University of Calgary - Tom Baker Cancer Centre	2005	2010
University of California - Los Angeles	1994	2008
University of Florida	2001	2011
University of Kentucky Medical Center	1998	2008
University of Oklahoma HSC	2005	2008
University of Texas HSC - Houston	1989	2007
University of Texas HSC - San Antonio	1997	2007
University of Wisconsin	1988	2007
Vanderbilt University School of Medicine	2003	2008
Wayne State University	1988	2008

ACCREDITED RESIDENCY PROGRAMS in MEDICAL PHYSICS

Accreditation:

**Commission on Accreditation of Medical Physics Educational Programs
(CAMPEP)**

Sponsored by: American Association of Physicists in Medicine (AAPM)
American College of Medical Physics (ACMP)
American College of Radiology (ACR)
Canadian College of Physicists in Medicine (CCPM)

CAMPEP Accredited Residency Programs in Medical Physics

Entries Last Updated Tuesday, April 4, 2007

Institution	Initial Accreditation	Expiration Date
Therapy		
Cross Cancer Institute - University of Alberta	2005	2010
London Regional Cancer Program	2006	2011
Mayo Clinic	2003	2008
McGill University	2000	2010
Tom Baker Cancer Centre	2005	2010
University of Chicago Medical Center	2004	2009
University of Florida	2000	2010
University of Louisville School of Medicine	2003	2008
University of Minnesota Medical School	2000	2010
University of Texas M.D. Anderson Cancer Center	2006	2011
University of Wisconsin	2004	2009
Vanderbilt University Medical Center	2004	2009
Washington University School of Medicine	1997	2008
Imaging		
Cross Cancer Institute - University of Alberta	2005	2010
University of Texas M. D. Anderson Cancer Center	2002	2007

Medical Physics Organizations



American Association of Physicists in Medicine



The Australasian College of Physical Scientists and Engineers in Medicine

A C P S E M



American College of Medical Physics



Association of Medical Physicists of India

CANADIAN ORGANIZATION OF MEDICAL PHYSICISTS



ORGANISATION CANADIENNE DES PHYSICIENS MÉDICAUX



European Federation of Organisations for Medical Physics

THE CANADIAN COLLEGE OF PHYSICISTS IN MEDICINE



LE COLLÈGE CANADIEN DES PHYSICIENS EN MÉDECINE

International Organization for Medical Physics



Deutsche Gesellschaft für Medizinische Physik e.V.

DGMP

Japan Society of Medical Physics



Institute of Physics and Engineering in Medicine

Schweizerische Gesellschaft für Strahlenbiologie und Medizinische Physik
Société Suisse de Radiobiologie et de Physique Médicale
Società Svizzera di Radiobiologia e di Fisica Medica
Swiss Society of Radiobiology and Medical Physics

Medical Physics World

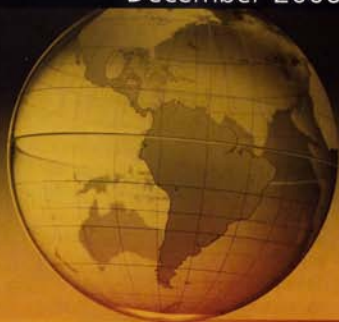

Bulletin of the International Organization for Medical Physics

www.iomp.org

75 Adhering National Organizations 2006

Algeria • Argentina • Australia • Austria • Bangladesh • Belgium • Brazil • Bulgaria • Canada • Chile • Colombia • Croatia • Cuba • Cyprus • Denmark • Ecuador • Egypt • Estonia • Finland • France • Georgia • Germany • Ghana • Greece • Hong Kong • Hungary • India • Indonesia • Iran • Ireland • Israel • Italy • Japan • Jordan • Korea • Lithuania • Malaysia • Mexico • Mexico Nuevo Leon • Moldova • Mongolia • Morocco • Nepal • Netherlands • New Zealand • Nigeria • Norway • Pakistan • Panama • People's Republic of China • Philippines • Poland • Portugal • Republic of China, Taiwan • Romania • Russia • Singapore • Slovenia • South Africa • Spain • Sri Lanka • Sudan • Sweden • Switzerland • Tanzania • Thailand • Trinidad & Tobago • Turkey • Uganda • Ukraine • United Kingdom • United States of America • Venezuela • Zambia • Zimbabwe



Barry J. Allen, Ph.D.;
President of IOMP

Incoming President's Report

Barry J. Allen, Ph.D.; President IOMP

As President-Elect of the International Organisation for Medical Physics (IOMP), I was appointed IOMP President at the International Congress on Medical Physics and Biomedical Engineering in Seoul, Korea last August. The IOMP covers some 16500 medical physicists around the world. Previously, I was President of the Asia-Oceania Federation for Medical Physics.

However, I became Acting-President a little sooner than expected because of the unfortunate absence of our President, Prof. Azam Nirmond-Rad. Azam was unable to attend for health reasons, and has since resigned from all her positions in the IOMP. Our best wishes go out to Azam, with the hope of a speedy recovery. The IOMP has developed in many ways under Azam's stewardship, and Azam has reported these initiatives in preceding issues of Medical Physics World. It's my job now to move on and to tell you of the challenges facing the IOMP, and how I expect to meet those challenges.

IOMP's first challenge is to ensure that all of its members, wherever they may

be, have the same access to medical physics knowledge. This can only be achieved via the web site. The website should become the means of communication with all members; the major resource for treatment protocols, educational and training materials. The website must become the first resource for use by its members, supplanting Google!

IOMP should act as a promoter of leading edge and appropriate technology and missions, identifying and promoting new areas for research, particularly for the developing world. Far too great a fraction of our research is in the high technology, high cost end. This needs to be rectified to allow developing countries to benefit from Western R&D.

In the past, Medical Physics World (MPW) has been the main means of communication with the membership but has had a very low impact factor. What is the role of MPW in the e-era? Clearly, both soft and hard copies of MPW provide commercial sponsors

(continued on page 5)



2006-2009 IOMP Officers

President



Prof. Barry Allen, BSc MSc PhD DSc FACPSEM FInst P

Director, Centre for Experimental Radiation Oncology
St George Hospital Cancer Care Centre
Gray St, Kogarah,
NSW 2217
Australia
Barry.allen@sesiahs.health.nsw.gov.au

Vice President



Prof. Dr. Fridtjof Nüsslin

Klinik für Strahlentherapie, Klinikum Rechts der Isar der
Technischen Universität München
Ismaninger Str.22
81675 München
Germany

nuesslin@lrz.tum.de

Secretary General



Dr. Peter Smith

Northern Ireland Regional Medical Physics Agency
Badger lodge
86 Lisbane Road
Saintfield
Ballynahinch
Co. Down, BT24 7BT
UK

peter.smith@mpa.ni.nhs.uk

Treasurer



Dr. George Mawko

Medical Physicist
Dept. of Diagnostic Radiology
QEII Health Sciences
1278 Tower Road
Halifax, Nova Scotia
Canada B3H 2Y9
g.mawko@dal.ca

Table of Contents

President's Message.....	01
Secretary-General's Article.....	02
IOMP Publications Committee.....	04
Report of the Scientific Committee.....	05
Report on World Congress 2006.....	06
Donation of Used Equipment.....	08
The Role of HBO in Rad Onc.....	10
Editor's Corner.....	13
IOMP Education and Training.....	16
Calendar of Events.....	20
Status of AAMP/OMP Libraries.....	20
Message from the Past President.....	22
Ad Rate Schedule.....	22

The Profession of Medical Physics

- Research**
- Service**
- Administration**
- Education**

MEDICAL PHYSICIST

- **Is a physicist** who works in medical environment, knows some medicine, and understands the use of physics in diagnosis and treatment of human disease.
- **Is not a health professional** who knows some physics and works with applications of physics in diagnosis and treatment of human disease.

Current trends

□ **Imaging physics**

- Molecular imaging
- Hybrid machines: MR/PET and MR simulator

□ **Radiotherapy physics**

- Monte Carlo treatment planning
- Proton and heavy ion radiotherapy
- MR integrated with cobalt-60 teletherapy
- Definition of biological target

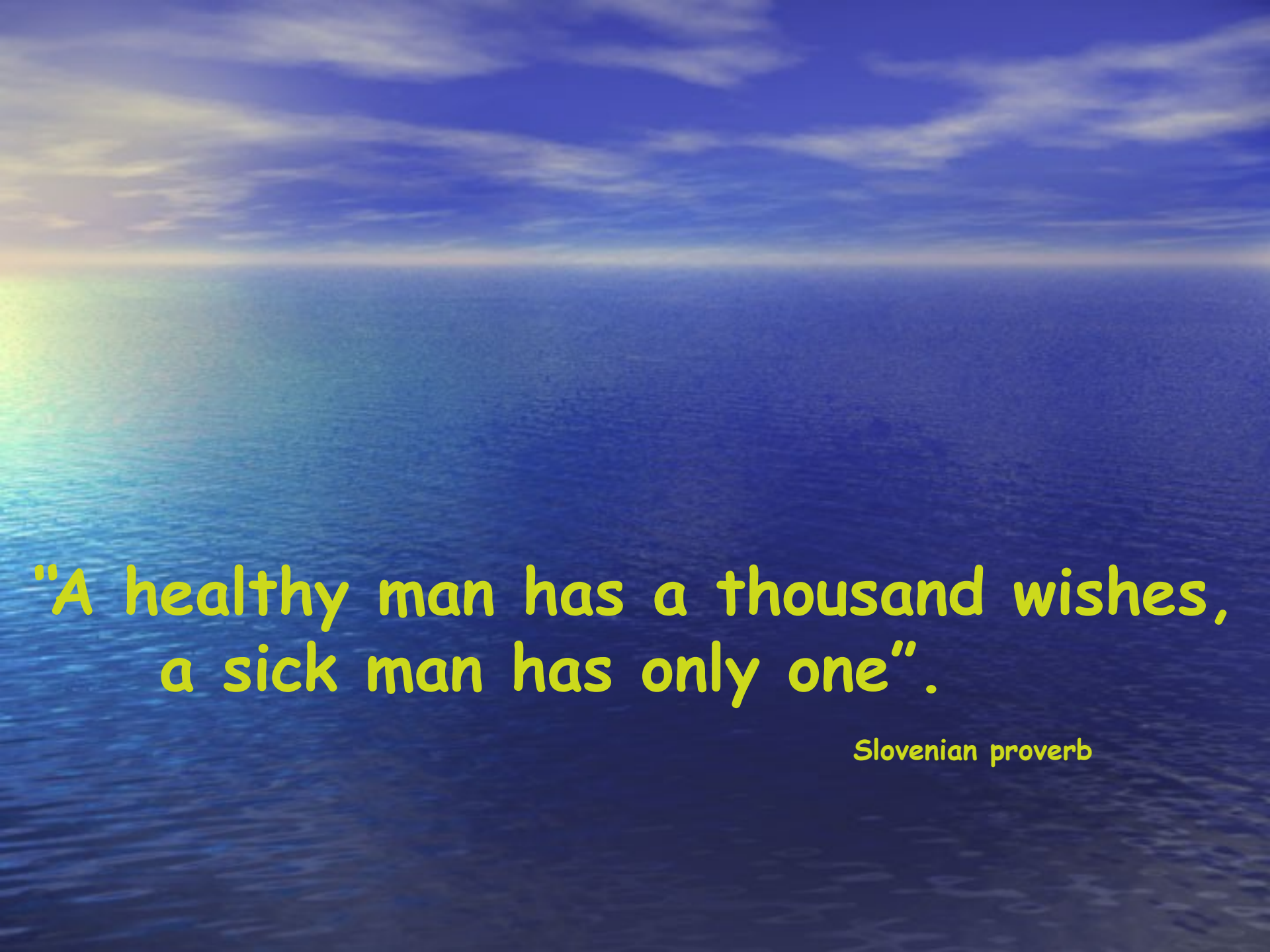

"A healthy man has a thousand wishes,
a sick man has only one".

Slovenian proverb